

Pumping speed curve

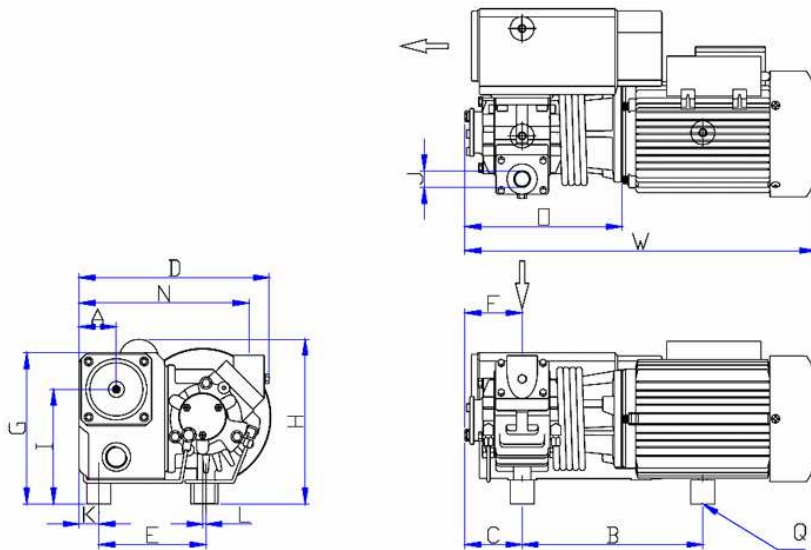
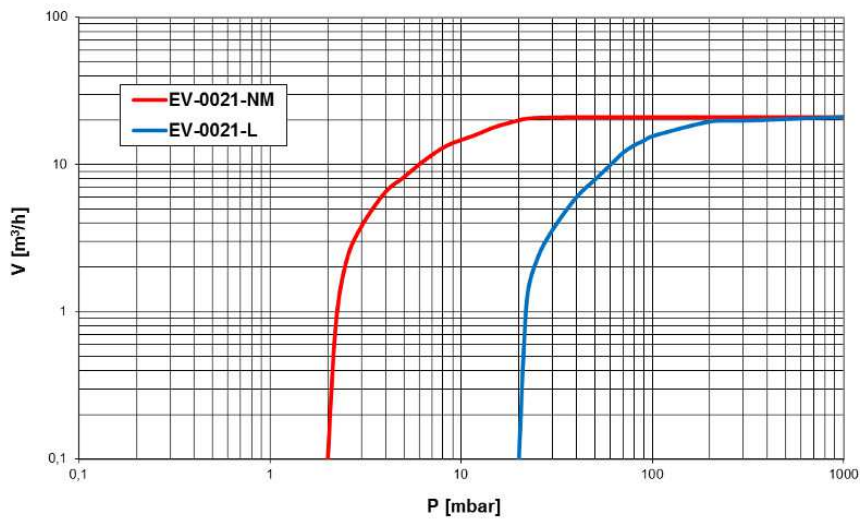

Dimensions	W	D	H	A	B	C	E	F	G	I	J	K	L	M	N	O	Q
EV-0021	385	300	200	47	217	72	135	72	190	144	½"	25	3	G 1¼"	214	198	3x M8

TYPE EV-0021

Technical Data		TYPE EV-0021	
		50 Hz	60 Hz
Nominal displacement	m ³ /h	20	24
Ultimate pressure NM type	mbar	2	2
L type	mbar	20	20
Motor power	kW	0,9	0,9
Nominal speed	rpm	2870	3480
Noise level	dB(A)	60	62
Operating temperature	°C	85	85
Oil capacity	ltr	0,5	0,5
Weight	kg	20	20
Admissible ambient temp.	°C	10 to 40	10 to 40
Connection Inlet	G(BSP)	½"	½"
Outlet	G(BSP)	1¼"	1¼"

Ordering Information	TYPE EV-0021	
	50 Hz	60 Hz
<u>NM version (2 mbar)</u> Single phase motor 230V, 50/60 Hz	103100	103100
Three phase motor 400V, 50Hz (IE2)		
400V, 60Hz (IE2)		103102
<u>L version (20 mbar)</u> Single phase motor 230V, 50/60 Hz	103200	103200
Three phase motor 400V, 50Hz (IE2)		
400V, 60Hz (IE2)	103201	103202
Other Voltages/Frequencies	Upon request	
Filling with special oil	Upon request	
Exhaust filter cartridge	02120A	
Service kit	02499	
Overhaul kit	02500	
Pump module	02900	
Inlet dust filter, paper cartridge	02800	