

TECHNICAL HANDBOOK

kina26e1-p (1209)



Catalog No.

520-001
520-002
520-003
520-004

520-103
520-104
520-105
520-106



from software version V 2.9

Protec P3000(XL)

Helium Sniffer Leak Detector

Content

	Content	0-3
	General Safety Precautions	0-6
<hr/>		
1	General Information	1-1
1.1	Introduction	1-1
1.1.1	Intended Use	1-1
1.1.2	Available Configurations	1-2
1.1.3	Technical Data	1-2
1.2	Support by INFICON	1-3
1.2.1	Service Centers	1-5
1.3	Unpacking	1-7
1.3.1	Supplied Equipment	1-7
1.3.2	Accessories	1-8
1.4	Notes on How to Use This Handbook	1-9
1.4.1	Symbols of Vacuum Technology	1-9
1.4.2	Definition of Terms	1-10
1.5	Instrument Views of the Protec P3000	1-11
1.6	Installation	1-12
1.6.1	Set up	1-12
1.6.2	Mechanical Connections	1-13
1.6.3	Electrical Connections	1-16
1.6.4	RS232 Interface	1-17
1.6.5	I/O Port	1-17
<hr/>		
2	How the Protec P3000 Works	2-1
2.1	Description of the Functions	2-1
2.2	Description of the Subassemblies	2-1
2.2.1	Backing Pump	2-1
2.2.2	Wise Technology™ Sensor	2-1
2.2.3	Valve Holder	2-2
2.2.4	Control Assembly	2-2
2.3	Description of the Displays and User Interfaces	2-2
2.3.1	Main unit display	2-2
2.3.2	SL3000(XL) Sniffer line with probe display	2-4
2.3.3	Built-in PRO-Check reference leak	2-5
<hr/>		
3	Operation of the Protec P3000	3-1
3.1	Start-Up	3-1
3.2	Controls on the main display unit	3-2
3.3	Controls on the probe display unit	3-5
3.4	Performing measurements	3-5
3.4.1	Standard Operation Mode	3-6
3.4.2	I•Guide Operating Mode	3-9
3.4.2.1	Starting the I•Guide Mode	3-9
3.4.2.2	Selecting an I•Guide Program	3-10
3.4.2.3	Using an I•Guide Program	3-10
3.4.3	The Info Page	3-13

3.5	Calibration and Self-Test	3-15
3.5.1	Verifying a calibration (proof function)	3-15
3.5.2	Internal calibration	3-17
3.5.3	External calibration	3-17
3.6	Standby	3-20
3.7	Shutdown	3-20
3.8	Storage for fast availability as back-up unit	3-20
<hr/>		
4	Equipment Settings	4-1
4.1	Menu Structure	4-1
4.2	The Service Menu	4-3
4.3	Selecting gas equivalents and setting trigger values	4-3
4.3.1	Setting gas parameters	4-3
4.3.2	Selecting a set of gas parameters	4-7
4.4	Settings Sub-menu	4-8
4.4.1	Vacuum & Access	4-8
4.4.2	Audio Functions	4-15
4.4.3	Display Settings	4-17
4.4.4	Setting-up / editing an I•Guide Program	4-19
4.4.5	Miscellaneous Settings	4-21
4.5	Interfaces	4-23
4.5.1	Control location	4-23
4.5.2	Recorder outputs	4-23
4.5.3	RS232 Protocol	4-25
4.5.4	Select PLC inputs	4-27
4.5.5	Baud rate & end sign	4-27
4.5.6	PRO-Check (only available in advanced mode)	4-27
4.6	The Info Menu	4-28
4.7	History & Maintenance	4-32
<hr/>		
5	Protec P3000 Messages	5-1
5.1	Error Messages and Warnings	5-1
<hr/>		
6	Equipment Connections	6-1
6.1	I/O Port (Control Inputs and Outputs)	6-1
6.1.1	Ground connectors	6-2
6.1.2	24V Output	6-2
6.1.3	PLC Inputs	6-2
6.1.4	PLC Outputs	6-3
6.1.4.1	Relay outputs	6-5
6.1.4.2	Recorder Outputs	6-5
6.1.5	How to perform a calibration?	6-6
6.2	RS232 interface	6-7
<hr/>		
7	Maintenance	7-1
7.1	Maintenance schedule	7-1
7.2	Exchanging the air filter	7-2
7.3	Exchanging the external fuses	7-4

7.4	Replacing filters in the sniffer line	7-4
7.4.1	Replacing the felt discs of the capillary filter (for SL3000 only)	7-5
7.4.2	Replacing the felt discs when using the water protection tip (for SL3000 only)	7-7
7.4.3	Checking / replacing the sinter filter (for SL3000 only)	7-7
7.5	Replacing the filter pad of the sniffer tip (for SL3000XL only)	7-9
7.6	Switching the capillary filter (for SL3000 sniffer line only)	7-11
7.6.1	Switching from metal to plastic capillary filter	7-11
7.6.2	Switching from plastic to metal capillary filter	7-12
7.7	Replacing the gas reservoir of the PRO-Check	7-13
<hr/>		
8	The gas library	8-1

General Safety Precautions



Warning

Indicates procedures that must be strictly observed to prevent hazards to persons.



Caution

Indicates procedures that must strictly be observed to prevent damage to or destruction of the Protec P3000 leak detector.

Notice Indicates special requirements the user must comply with.

The INFICON Protec P3000 leak detector has been designed for safe and efficient operation when used properly and in accordance with this Technical Handbook. It is the responsibility of the user to carefully read and strictly observe all safety precautions described in this chapter and throughout this Technical Handbook. The Protec P3000 must only be operated in the proper condition and under the conditions described in this Technical Handbook. It must be operated and maintained by trained personal only. Consult local, state, and national agencies regarding specific requirements and regulations. Address any further safety, operation and / or maintenance questions to our nearest office.

Failure to observe the following precautions could result in serious personal injury:



Warning

Danger of explosion!

To use the Protec P3000 in explosion hazard areas could cause ignition of flammable mixtures.

The Protec P3000 must only be operated outside of explosion hazard areas.



Warning

Only 3-core mains cables having a protective ground conductor must be used. Operation of the Protec P3000 with the ground conductor unconnected is not permissible.

**Warning**

Do not stare into the LEDs of the sniffer line intentionally for extended times or at a close distance as this may cause permanent damage to the eye.

**Warning**

Danger of electric shock.

Don't touch voltaged parts with the sniffer tip. Test samples need to be disconnected from electricity before leak testing.

**Warning**

For all contacts of the I/O Port a maximum voltage of 60 V DC or 25 V AC must not be exceeded or reached to ground or ground equipment conductors.

According to the type of in- or outputs lower voltages had to be accepted. For this, please refer to the information given in the responding chapters.

**Warning**

For all maintenance on the Protec P3000, the Protec P3000 must be disconnected from power.

**Warning**

Before exchanging the air filter the Protec P3000 must be disconnected from power.

**Warning**

Before exchanging the fuses the Protec P3000 must be disconnected from power.

Failure to observe the following precautions could result in damage to the equipment:



Caution

The Protec P3000 must not be operated while standing in water or when exposed to drip water. The same applies to all other kinds of liquids.

This Protec P3000 should only be used in rooms.



Caution

Avoid contact of the Protec P3000 with bases, acids and solvents as well as exposure to extreme climatic conditions.



Caution

Ensure sufficient air cooling (see also Section 1.1.2)



Caution

Before installation remove the transportation lock.



Caution

In order to ensure adequate ventilation of the Protec P3000, a space of at least 20 cm (8 in.) must be kept unobstructed to the sides. The clearance at the rear must be no less than 10 cm (4 in.). Moreover, the Protec P3000 handles for carrying the leak detector at the sides of the main unit must not be covered at any time as these acts as air inlet and outlet. Avoid the presence of heat sources in the vicinity of the Protec P3000.



Caution

Before connecting the Protec P3000 to the mains you must make sure that the mains voltage rating of the Protec P3000 coincides with the locally available mains voltage.



Caution

Do not suck in any liquids.

**Caution**

Permissible maximum input voltage PLC 28 V.

**Caution**

Permissible max. voltage and current for open collector outputs are: 28 V; 50 mA.

**Caution**

Maximum load rating relay outputs is 60 V DC / 25 V AC and 1 A per relay.

**Caution**

The air filter should be checked for contamination at least every 6 months and should be definitely exchanged after 2 years.

1 General Information

The Protec P3000 helium leak detector is supplied ready for operation. However, we recommend that you carefully read the Technical Handbook to ensure optimum operating conditions right from the start. This handbook contains important information on functions, installation, start-up and operation of the Protec P3000.

If not stated otherwise this technical handbook applies to all three configurations of the Protec P3000 (see Section 1.1.2). Sections specific to one configuration are marked as "for ... only". Sections marked as "for Protec P3000XL only" always apply to the Protec P3000XL with the SL3000XL sniffer line (capable of HIGH FLOW mode).

1.1 Introduction

1.1.1 Intended Use

The Protec P3000 is a helium leak detector for sniffer applications. It may be used to localise and quantify leaks in test samples if there is helium under an overpressure within the test sample and when searching the test sample with a sniffer probe from the outside (sniffer method). The use of this sniffer probe is mandatory for proper operation and it is available as an accessory (Cat. No. 525-001 to 525-004).



Caution

The Protec P3000 must not be operated while standing in water or when exposed to drip water. The same applies to all other kinds of liquids.

This Protec P3000 should only be used in rooms.



Caution

Avoid contact of the Protec P3000 with bases, acids and solvents as well as exposure to extreme climatic conditions.



Caution

Ensure sufficient air cooling (see also Section 1.1.2)

1.1.2 Available Configurations

The Protec P3000 leak detector is available in four different configurations:

The Standard Protec P3000

The standard Protec P3000 should be used for high sensitivity applications. It requires the SL3000 sniffer line.

The Protec P3000, RC version

The Protec P3000, RC version is the standard Protec P3000 but with an external display unit. It requires the SL3000 sniffer line.

The Protec P3000XL

The Protec P3000XL is the HIGH FLOW version of the Protec P3000. It is able to detect leaks at a much higher distance from the potential leak at reduced sensitivity but can be switched back to normal flow at increased sensitivity. In order to use both flow modes (high and low) it requires the use of the SL3000XL sniffer line. It may also be operated with the normal SL3000 sniffer line, in this case the high flow mode is disabled, however.

The Protec P3000XL, RC version

The Protec P3000XL, RC version is identical to the Protec P3000XL, but with an external display unit. It requires the SL3000XL sniffer line.

1.1.3 Technical Data

Physical Data

Lowest detectable leak rate	
For Protec P3000	1 x 10 ⁻⁷ mbar l/s
For Protec P3000XL in LOW FLOW mode	1 x 10 ⁻⁷ mbar l/s
For Protec P3000XL in HIGH FLOW mode	1 x 10 ⁻⁶ mbar l/s
Measurement range	
For Protec P3000	5 decades
For Protec P3000XL in HIGH FLOW mode	4 decades
Helium sensor	Wise Technology™ Sensor
Sensor response time	450 ms

Gas flow through the capillary	
For Protec P3000	260 - 360 sccm*
For Protec P3000XL in HIGH FLOW mode	2660 - 3500 sccm*
Time until ready for operation	approx. 3 min

* Measured at 1 atm (1013 mbar) at sea altitude. Actual flow may vary with increased altitude and low atmospheric pressure.

Electrical Data

Mains voltages and mains frequencies (fixed)	90 - 127 V, 50 / 60 Hz 115 - 140 V, 60 Hz 187 - 265 V, 50 / 60 Hz
Power consumption	200 VA
Type of protection	IP 20
Overvoltage category	II
Mains cord	2.5 m
Noise level	< 54 dBA

Other data

Dimensions (w x h x d) in mm	610 x 370 x 265
Weight	27 kg
Permissible ambient temperature (during operation)	10 °C to 45 °C
Permissible storage temperature	-40 °C to 60 °C
Relative humidity	max. 80% for temperature up to +31°C, decreasing linearly to 50% at +40°C
Contamination level	II (according to IEC 61010 / Part 1: "normally only non-conductive pollution may occur. Occasionally, however, a temporary conductivity caused by condensation can be tolerated.")
Max. altitude above sea level	2000m

1.2 Support by INFICON

INFICON Service

If equipment is returned to INFICON or an authorised INFICON representative indicate whether the equipment is free of substances damaging to health or whether it is contaminated. If it is contaminated also indicate the nature of the hazard. INFICON must return any equipment without a Declaration of Contamination to the sender's address. You will find an appropriate form below.

General

We reserve the right to alter the design or any data given in this handbook.
The illustrations are not binding.

Declaration of Contamination

The service, repair, and/or disposal of vacuum equipment and components will only be carried out if a correctly completed declaration has been submitted. Non-completion will result in delay.
This declaration may only be completed (in block letters) and signed by authorized and qualified staff.

1 Description of product

Type _____
Article Number _____
Serial Number _____

2 Reason for return

3 Operating fluid(s) used (Must be drained before shipping.)

4 Process related contamination of product:

toxic	no <input type="checkbox"/> 1)	yes <input type="checkbox"/>	
caustic	no <input type="checkbox"/> 1)	yes <input type="checkbox"/>	
biological hazard	no <input type="checkbox"/>	yes <input type="checkbox"/> 2)	
explosive	no <input type="checkbox"/>	yes <input type="checkbox"/> 2)	
radioactive	no <input type="checkbox"/>	yes <input type="checkbox"/> 2)	
other harmful substances	no <input type="checkbox"/> 1)	yes <input type="checkbox"/>	

2) Products thus contaminated will not be accepted without written evidence of decontamination!

The product is free of any substances which are damaging to health yes

1) or not containing any amount of hazardous residues that exceed the permissible exposure limits

5 Harmful substances, gases and/or by-products

Please list all substances, gases, and by-products which the product may have come into contact with:

Trade/product name	Chemical name (or symbol)	Precautions associated with substance	Action if human contact

6 Legally binding declaration:

I/we hereby declare that the information on this form is complete and accurate and that I/we will assume any further costs that may arise. The contaminated product will be dispatched in accordance with the applicable regulations.

Organization/company _____

Address _____ Post code, place _____

Phone _____ Fax _____

Email _____

Name _____

Date and legally binding signature _____ Company stamp _____

This form can be downloaded from our website. Copies: Original for addressee - 1 copy for accompanying documents - 1 copy for file of sender

Fig. 1-1 Declaration of Contamination

1.2.1 Service Centers

Algeria	jhj@agramkow.dk	Finland	jhj@agramkow.dk
Agramkow	Phone: +45 741 236 36	Agramkow	Phone: +45 741 236 36
Sonderborg	Fax: +45 744 336 46	Sonderborg	Fax: +45 744 336 46
Belarus	leakdetection.service@inficon.com	France	Christophe.Zaffanella@oerlikon.com
INFICON GmbH	Phone: +49 221 56788-112	OLV France	Phone: +33 476 351 584
Cologne	Fax: +49 221 56788-9112	Orsay	Fax: +33 476 351 584
Belgium	leakdetection.service@inficon.com	Germany	leakdetection.service@inficon.com
INFICON GmbH	Phone: +49 221 56788-112	INFICON GmbH	Phone: +49 221 56788-112
Cologne	Fax: +49 221 56788-9112	Cologne	Fax: +49 221 56788-9112
Brazil	fernandoz@prestvacuo.com.br	Hungary	adam.lovics@kon-trade.hu
PV Pest Vácuo Ltda.	Phone: +55 114 154 4888	Kontrade	Phone: +36 23 50 38 80
Santa de Parnaíba	Fax: +55 114 154 4888	Budaörs	Fax: +36 23 50 38 96
Bulgaria	leakdetection.service@inficon.com	India	asdash@hotmail.com
INFICON GmbH	Phone: +49 221 56788-112	Dashpute	Phone: +91 22 888 0324
Cologne	Fax: +49 221 56788-9112	400 064	Fax: +91 22 888 0324
Canada	reachus@vpcinc.ca	Ireland	reach.unitedkingdom@inficon.com
Vacuum Products Canada Ltd.	Phone: +905.672.7704	INFICON	Phone: +44 1254 678 250
Ontario	Fax: +905.672.2249	Blackburn	Fax: +44 1254 698 577
Central America	infoqro@meisa.com	Italy	davide.giovanetti@inficon.com
MEISA S.a. de C.V.	Phone: +52 44 22 25 42 80	INFICON GmbH	Phone: +39 045 6 40 25 56
Querétaro	Fax: +52 44 22 25 41 57	Castelnuovo	Fax: +39 045 6 40 24 21
China	reach.china@inficon.com	Israel	urimark@mark-tec.co.il
INFICON LTD	Phone: +852.2862.8863	Mark Technologies Ltd.	Phone: +972 35 34 68 22
Hong Kong	Fax: +852.2865.6883	Kiriat Ono	Fax: +972 35 34 25 89
INFICON LTD	Phone: +86.10.6590.0164	Japan	reach.japan@inficon.com
Beijing	Fax: +86.10.6590.0521	INFICON Co. Ltd.	Phone: +81.45.471.3396
INFICON LTD	Phone: +86.20.8723.6889	Yokohama	Fax: +81.45.471.3387
Guangzhou	Fax: +86.20.8723.6003		
INFICON LTD	Phone: +86.21.6209.3094		
Shanghai	Fax: +86.21.6295.2852		
Czech Republic	filip.lisec@inficon.com	Korea	reach.korea@inficon.com
INFICON GmbH	Phone +420 734 331 758	INFICON Ltd.	Phone: +82 312 062 890
Pilsen	Fax: +420 604 203 037	Sungnam city	Fax: +82 312 063 058
Denmark	jhj@agramkow.dk	INFICON Ltd.	Phone: +82 312 062 890
Agramkow	Phone: +45 744 336 36	Suwon City	Fax: +82 312 063 058
Sonderborg	Fax: +45 744 336 46	INFICON Ltd.	Phone: +82 312 062 890
		Cheonan City	Fax: +82 312 063 058
Egypt	jhj@agramkow.dk	Latvia	leakdetection.service@inficon.com
Agramkow	Phone: +45 741 236 36	INFICON GmbH	Phone: +49 221 56788-112
Sonderborg	Fax: +45 744 336 46	Cologne	Fax: +49 221 56788-9112
Estonia	leakdetection.service@inficon.com	Lithuania	leakdetection.service@inficon.com
INFICON GmbH	Phone: +49 221 56788-112	INFICON GmbH	Phone: +49 221 56788-112
Cologne	Fax: +49 221 56788-9112	Cologne	Fax: +49 221 56788-9112

Mexico MEISA S.a. de C.V. Querétaro	infoqro@meisa.com Phone: +52 442 225 42 80 Fax: +52 442 225 41 57	Spain Leybold Optics Ibérica Barcelona	richard.cunill@leyboldoptics.com Phone: +34 93 66 60 778 Fax: +34 93 66 64 612
Netherlands INFICON GmbH Cologne	leakdetection.service@inficon.com Phone: +49 221 56788-112 Fax: +49 221 56788-9112	Sweden Agramkow Sonderborg	jhj@agramkow.dk Phone: +45 741 236 36 Fax: +45 744 336 46
Norway Agramkow Sonderborg	jhj@agramkow.dk Phone: +45 741 236 36 Fax: +45 744 336 46	Syria INFICON GmbH Cologne	leakdetection.service@inficon.com Phone: +49 221 56788-112 Fax: +49 221 56788-9112
Poland VAK-POL & GAZ Sp. zo.o Pulawy	kamola@vakpol.com Phone: +48 60 23 15 212 Fax: +48 60 23 15 212	Taiwan INFICON Company Limited Chupei City, HsinChu Hsien	Susan.Chang@inficon.com Phone: +886.3.5525.828 Fax: +886.3.5525.829
Portugal INFICON GmbH Cologne	leakdetection.service@inficon.com Phone: +49 221 56788-112 Fax: +49 221 56788-9112	Tunisia INFICON GmbH Cologne	leakdetection.service@inficon.com Phone: +49 221 56788-112 Fax: +49 221 56788-9112
Republic of South Africa Vacuquip Randburg	vacuquip@hotmail.com Phone: +27 73 15 78 355	Turkey Agramkow Sonderborg	jhj@agramkow.dk Phone: +45 741 236 36 Fax: +45 744 336 46
Russia INFICON GmbH Cologne	leakdetection.service@inficon.com Phone: +49 221 56788-112 Fax: +49 221 56788-9112	Ukraine INFICON GmbH Cologne	leakdetection.service@inficon.com Phone: +49 221 56788-112 Fax: +49 221 56788-9112
Singapore INFICON PTE LTD. Singapur	reach.singapore@inficon.com Phone: +65.890.6250 Fax: +65.890.6266	United Kingdom INFICON Blackburn	reach.unitedkingdom@inficon.com Phone: +44 1254 678 250 Fax: +44 1254 698 577
Slovakia INFICON GmbH Pilsen	filip.lisec@inficon.com Phone +420 734 331 758 Fax: +420 604 203 037	United Arab Emirates INFICON GmbH Cologne	leakdetection.service@inficon.com Phone: +49 221 56788-112 Fax: +49 221 56788-9112
Slovenia Medivac Ljubljani	medivak@siol.net Phone: +386 15 63 91 50 Fax: +386 17 22 04 51	USA Inficon Inc. East Syracuse, NY	service.usa@inficon.com Phone: +1.315.434.1167 Fax: +1.315.434.2551
South America except Brazil MEISA S.a. de C.V. Querétaro	infoqro@meisa.com Phone: +52 44 22 12 36 15 Fax: +52 44 22 12 19 40	Inficon Inc. San Jose, CA Inficon Inc. Austin, TX	Phone: +1.408.361.1200 Fax: +1.408.362.1556 Phone: +1.512.448.0488 Fax: +1.512.448.0398

1.3 Unpacking

Unpack the Protec P3000 leak detector immediately after it has been received even if it is to be put into operation at some later date. Examine the shipping container for any external damage. Completely remove all packaging materials.

Notice Retain the shipping container and the packaging materials in the event of possible complaints concerning any damages.

Check if the Protec P3000 leak detector is complete (see Section 1.3.1) and carefully subject it to a visual inspection. If any damage is discovered please immediately inform the forwarding agent and the insurers. If it is required to exchange the damaged part please contact our orders department.

1.3.1 Supplied Equipment

The Protec P3000 leak detector is ready for operation. Before installation please read Section 1.5. Included with the leak detector are the following items:

- Protec P3000 (main unit)
- Mains cord, 3m long
- Set of fuses (3 x 10 pcs.)
- Spare air filter
- 8 mm hexagonal wrench
- Documentation
 - Operating Instructions (kima26)
 - Technical Handbook Protec P3000 (kina26e1)
 - Spare Parts List Protec P3000 (kiua26d2)
 - Interface Description Protec P3000 (kins26e1)

Notice The SL3000 and SL3000XL sniffer lines are available in different configurations and need to be ordered separately in the desired length. The SL3000(XL) sniffer line is not part of the Protec P3000 shipment. (see Section 1.3.2 Accessories)

Notice The PRO-Check reference leak is an accessory (see Section 1.3.2 Accessories) and needs to be ordered separately

Notice For the RC versions the display unit and the connecting cable are not part of the standard Protec P3000 shipment and need to be ordered separately (see Section 1.3.2)

1.3.2 Accessories

For Protec P3000

	Cat. No. / Ref. No.
SL3000 Sniffer line for Protec P3000	
SL3000-3, 3 m length	525-001
SL3000-5, 5 m length	525-002
SL3000-10, 10 m length	525-003
SL3000-15, 15 m length	525-004
Sniffer tips for SL3000	
ST 312, 120 mm, rigid	122 13
FT 312, 120 mm, flexible	122 14
FT 200, 200 mm, rigid	122 18
FT 250, 250 mm, flexible	122 66
ST 385, 385 mm, rigid	122 15
FT 385, 385 mm, flexible	122 16
FT 600, 600 mm, flexible	122 09
ST 500, 500 mm, rigid, 45° angled	122 75
Water protection tip for sniffer	122 46

For Protec P3000XL only

SL3000XL Sniffer line for Protec P3000XL	
SL3000XL-3, 3 m length	521-011
SL3000XL-5, 5 m length	521-012
SL3000XL-10, 10 m length	521-013
SL3000XL-15, 15 m length	521-014
Sniffer tips for SL3000XL	
ST 312XL, 120 mm, rigid	122 80
FT 312XL, 120 mm, flexible	122 81
ST 385XL, 385 mm, rigid	122 82
FT 385XL, 385 mm, flexible	122 83
FT 250XL, 250 mm, flexible	122 85

For RC versions only

External display unit	
for benchtop use	551-100
for rack mounting	551-101
Connecting cable for external display unit	
5m length	551-102
Connecting cable for external display unit	
0.7m length	551-003

*For all Protec P3000
configurations*

Holder for SL3000(XL)	525-006
PRO-Check reference leak for helium	521-001
Calibrated sniffer leaks for helium	
S-TL 4, approx. 1×10^{-4} mbar l/s	122 37
S-TL 5, range 10^{-5} mbar l/s	122 38
S-TL 6, range 10^{-6} mbar l/s	122 39

1.4 Notes on How to Use This Handbook

Important remarks concerning operational safety and protection are emphasised as follows:

Notice Indicates special requirements the user must comply with.



Warning

Indicates procedures that must be strictly observed to prevent hazards to persons.



Caution

Indicates procedures that must strictly be observed to prevent damage to or destruction of the Protec P3000 leak detector.

The references to diagrams, e.g. (2-1/6) consist of the Section No., Fig. No. and the Item No. in that order. For example: (2-1/6) means Section 2, Fig. 1 and Item No. 6 (here: mains switch).

1.4.1 Symbols of Vacuum Technology

In the following some important symbols of vacuum technology as used in this handbook are shown:

Diaphragm pump



Vacuum gauge



1.4.2 Definition of Terms

Main menu

This menu is shown first after operating the Menu push-button.

Sub-menus

Comprise all menus which may be accessed from the main menu. Unauthorised changes to many of these sub-menus may be prevented by a password (see also Section 4.3.1).

Menu item

A single menu line.

Default condition

Status of the Protec P3000 when supplied from the factory.

Service menu

Comprises the menu lines in the "Service" sub-menu. The service menu is accessed by scrolling in the basic menu using the navigation push-buttons (see also Section 3.2).

Autozero

Determination and compensation of the helium background. With this function, the internal ZERO level of the leak rate signal is determined in order to avoid a readout of the internal helium background and mistaking it as a properly measured value. If subsequently negative leak rates are obtained due to this correction, the stored offset values are changed so that ZERO will be the lowest value which can be obtained. In this way the values adapt automatically to a decaying background (adaptive background correction).

Internal background

The existing partial pressure in the measurement system. The level of the internal background is measured all the time and subtracted from the measured signal.

I•Guide Mode

In the I•Guide Mode different testing plans can be pre-programmed. During testing the operator is then constantly prompted for the next action and thus guided through the testing plan.

Unit under test

Test object that needs to be leak checked.

Display limit

Limits the measurement data displayed depending on the unit of measurement and the operator settings.

1.5 Instrument Views of the Protec P3000



Fig. 1-2 Instrument views of Protec P3000

Pos.	Description	Pos.	Description
1	Main display	4	Lemo Connector for SL3000 sniffer line
2	Speaker	5	Handle fore carrying the Protec P3000
3	PRO-Check reference leak		

1.6 Installation

1.6.1 Set up

How to remove the transportation lock:

The transportation lock is located on the bottom side of the Protec P3000 and consists of a yellow knurled screws. Please remove this screw before starting-up the leak detector. The Protec P3000 is supplied ready for operation. Initial start-up is described in Section 3.1.



Fig. 1-3 Removing the transportation lock before starting



Caution

Before installation remove the transportation lock.



Caution

In order to ensure adequate ventilation of the Protec P3000, a space of at least 20 cm (8 in.) must be kept unobstructed to the sides. The clearance at the rear must be no less than 10 cm (4 in.). Moreover, the Protec P3000 handles for carrying the leak detector at the sides of the main unit must not be covered at any time as these acts as air inlet and outlet. Avoid the presence of heat sources in the vicinity of the Protec P3000.

1.6.2 Mechanical Connections



Caution

Twisting the sniffer line spoils the cable.

Do not twist the sniffer line.

SL3000(XL) Sniffer line

In order to operate the Protec P3000 it is essential for the SL3000(XL) sniffer line to be connected. The connection for the sniffer line is located at the front of the Protec P3000 left of the PRO-Check reference leak. Insert the plug into the opening with the red dot on the plug and the slot in the front cover aligned until the connector engages. To disconnect the plug, retract the coupling and remove the probe's line.

Water protection tip (optional)

If you intend to perform leak testing on parts that are not completely dry (e.g. due to condensation after performance testing), we strongly recommend to use a water protection tip.

To install the water protection tip,

- 1 screw off the metallic capillary filter at the very end of the sniffer tip and
- 2 install the water protection tip instead.

Notice Please do not forget to re-install the little rubber seal when switching to the water protection tip.



Fig. 1-4 Installing water protection tip

PRO-Check Reference leak (optional)

Please insert the PRO-Check reference leak into the opening in the housing of the main unit. Make sure that the Sub-D plug is properly connected with the PRO-Check leak.

Notice When properly inserted, the PRO-Check reference leak will still protrude by approx. 10 mm.

On first usage of your PRO-Check you need to initialize the use of this reference leak in the Protec P3000 software.

Please perform the following steps:

- 1** Insert the PRO-Check into the appropriate opening of the Protec P3000
- 2** In the software menu go to HISTORY & MAINTENANCE / REPLACE PRO-CHECK.

Notice This menu item is only available when the Protec P3000 is set to ADVANCED MODE (see Section 4.4.3, Keyword: User Mode)

- 3** On the certificate, which is delivered with the PRO-Check, you will find a serial number and a 12-digit-code. Enter the serial number in the first line of the open submenu and the 12-digit-code in the second line and press OK.

Notice The PRO-Check reference leak must be installed in the Protec P3000 when pressing OK.

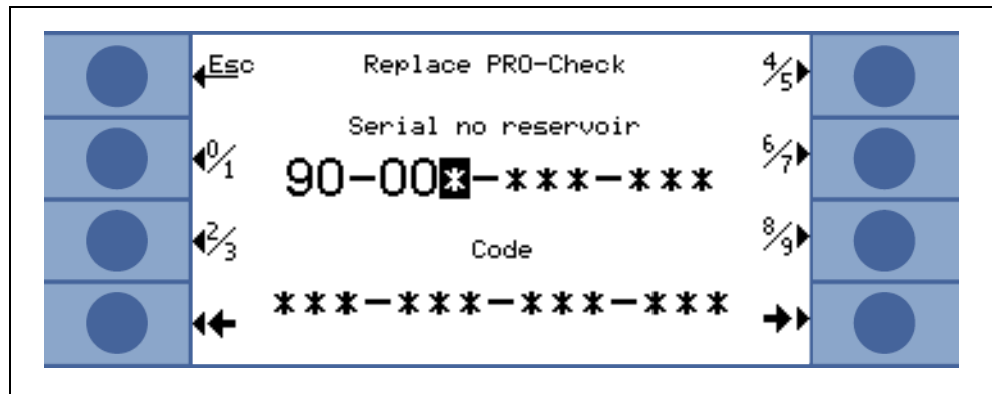

Fig. 1-5 Initializing the PRO-Check reference leak

Notice PRO-Check Warrtime Expire Date (See Section 7.7.5).

For RC versions only

The RC version has no built-in display unit but a connectors plate is mounted instead. Please connect the external display unit with the 5m connecting table (Cat.-no. 551-002)

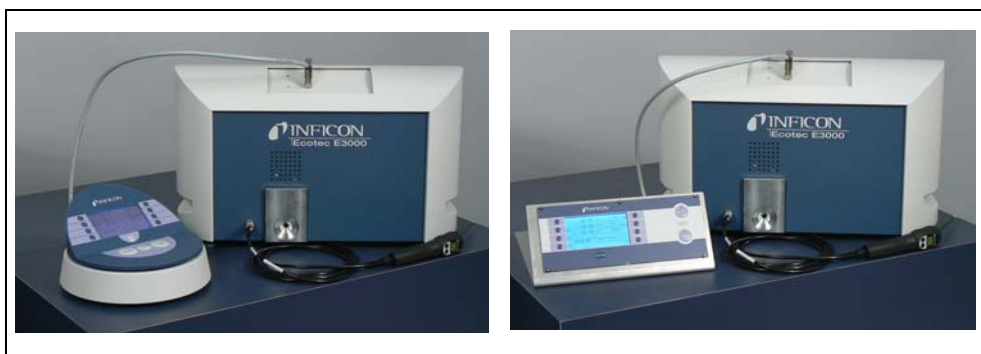

Fig. 1-6 Protec P3000 with external display unit for: (a) benchtop use (left side), (b) rack mounting (right side)

*Holder for SL3000
sniffer line (optional)*

An optional holder for the SL3000 sniffer line is available as cat.-no. 525-006. The holder may be installed on the right or left side of the main unit (for right- or left handed operators) as shown in [Fig. 1-8](#).



Fig. 1-7 Usage of sniffer line holder

The installation is described in [Fig. 1-8](#). There are two little slots on the front side at the very top area of the blue square front of the main unit. Hold the holder horizontally and then insert the two little hooks of the holder into the two slots (either on the right or the left side). With the hooks still inserted, let the holder flap down. It will automatically attach to the metal front by the magnet on the backside of the holder. Now insert the sniffer probe grip into the opening of the holder and let it sink down until it rests in the holder.



Fig. 1-8 Installation of sniffer line holder

1.6.3 Electrical Connections



Fig. 1-9 Electrical connections

Pos.	Description	Pos.	Description
1	Headphone port	4	Name plate
2	I/O Port	5	Power switch
3	RS232 interface	6	Power connector

Notice The local regulations for electrical connections must always be observed (in Germany VDE 0100). The mains voltage rating for the Protec P3000 can be read off from the name plate left of the power switch. The mains voltage setting of the Protec P3000 is fixed and can not be changed. A separate fuse for each of the mains conductors has been integrated into the mains socket (Fig. 1-9/6).

The mains voltage is applied to the Protec P3000 via the detachable mains cable which is supplied with the leak detector. A main power socket is available for this purpose at the rear of the main unit.

Caution

Before connecting the Protec P3000 to the mains you must make sure that the mains voltage rating of the Protec P3000 coincides with the locally available mains voltage.

**Warning**

Only 3-core mains cables having a protective ground conductor must be used. Operation of the Protec P3000 with the ground conductor unconnected is not permissible.

1.6.4 RS232 Interface

The Protec P3000 is equipped with a RS232 interface which is located on the rear right side of the main unit. This interface is of the DCE type (Data Communications Equipment) and allows the connection of a PC for monitoring and data logging. The connection is provided through a commercially available Sub-D plug. For further information see "Interface Description Protec P3000" (kins26e1).

1.6.5 I/O Port

The I/O port allows communication with and control through external equipment via PLC and analog data. For details see Section 6.1.

Through this connection some functions of the Protec P3000 can be controlled externally or measurement data or the status of the Protec P3000 may be communicated to external equipment.

Through relay changeover contacts the trigger levels as well as the operating mode (Ready) of the Protec P3000 may be monitored.

2 *How the Protec P3000 Works*

2.1 *Description of the Functions*

The Protec P3000 takes in helium through the SL3000 sniffer line, detects the amount of helium by means of a helium sensitive sensor and converts the sensor signal into quantitative leak rates.

The Protec P3000 is composed of the following principal subassemblies:

- A Wise Technology sensor as helium detector
- A valve holder for controlling different operating stati
- A diaphragm pump for pumping the gas to the sensor
- An inlet system for the gas flow
- The corresponding electrical and electronic subassemblies for supplying power and for signal conditioning.

The detector operates under gross vacuum conditions, i. e. the operating pressure at the detector is several 100 mbar. The under pressure is generated by a diaphragm pump. The pressure in front of the sensor is measured with a piezo-resistant pressure gauge and is about 250 mbar under normal operating conditions.

2.2 *Description of the Subassemblies*

2.2.1 *Backing Pump*

A diaphragm pump in the Protec P3000 serves as the backing pump. All data and further information on this pump are given in the Operating Instructions. The backing pump generates the flow of the gas through the SL3000 sniffer line.

2.2.2 *Wise Technology™ Sensor*

The helium detector (Wise Technology™ sensor) consists of a closed glass container with a measurement device for the precise determination of the pressure inside the glass housing and a membrane chip with a large number of small quartz windows. The membrane is permeable only for helium, all other components of air are retained by the membrane and from the inside of the glass housing. The Quartz membrane is heated so that the permeation for helium is sufficiently high and fast.

Inside of the glass housing the total pressure is measured precisely. As only helium can enter the glass housing the total pressure is equal to the partial pressure of helium. The determined total pressure inside the housing is proportional to the helium partial pressure outside the sensor.

2.2.3 Valve Holder

The valve holder carries the valves that control the gas flow to the Wise Technology sensor. These valves are used to select the sensitivity of the system, to activate a protection mode against high helium contamination and to set the system into STANDBY mode. The Protec P3000 software continuously analyses the situation and sets the correct valve position via the control unit.

2.2.4 Control Assembly

The control assembly (microprocessor) is the central assembly of the Protec P3000's electronics. All other subassemblies are controlled and monitored by this assembly. The microprocessor which is located here is thus continuously informed about the status of the entire Protec P3000 and can respond accordingly. In order to accept commands from the operator and to output measured values and messages, the control subassembly is linked to the display unit.

2.3 Description of the Displays and User Interfaces

2.3.1 Main unit display

This subassembly is used to communicate with the operator. It accepts commands from the 8 keys on both sides of the display and outputs measurement results and messages via the display.



Fig. 2-1 Main unit display

Pos.	Description	Pos.	Description
1	Menu buttons 1 to 4	2	Menu buttons 5 to 8

For RC versions only

The RC version has a connectors plate for the external display unit instead of the built-in main unit display. Two LED's left of the plug provide information about the status of the Protec P3000, even when the external display unit is disconnected:

- The green LED will indicate that the Protec P3000 is in operation (switched on). The green LED will show continuous green light if an external display unit is connected and will blink if no external display unit is detected.
- The red LED will be blinking in case of an error message, continuous red light indicates a warning.

If no display unit is connected, error messages or warnings may be acknowledged by pressing both buttons of the SL3000 sniffer line simultaneously.

The external display unit also offers four buttons:

- The START / STOP buttons have no function (the external display unit may also be used with other INFICON leak detectors which need these buttons)
- The MENU button will open the software menu.
- The ZERO button will set the current background reading to zero. (For details on the ZERO function see Section 4.4.1)

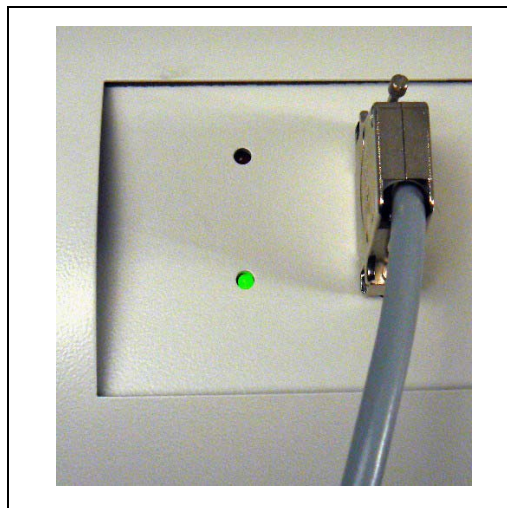

Fig. 2-2 Conncetor plate with LEDs

2.3.2 SL3000(XL) Sniffer line with probe display

The probe handle also offers a small display for operating the Protec P3000 remotely without access to the main unit during normal leak detection operation.

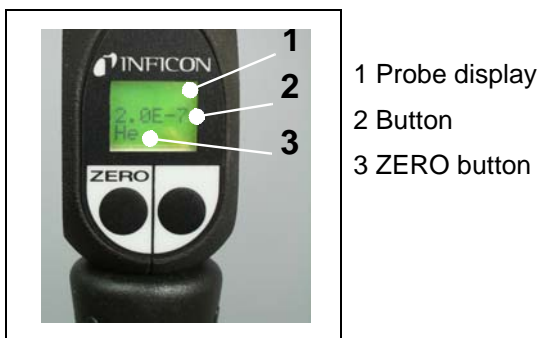

Fig. 2-3 SL3000(XL)Sniffer line with probe display

In addition to the display, the sniffer probe offers two press buttons. The left button will function as the ZERO button in any operating mode. By pressing the left button the current background reading is set to ZERO. For details on the ZERO function see section 4.4.1)

The right probe button is used for different functions depending on the current operating mode the Protec P3000 is set to:

- in standard operation mode:
 - no function for Protec P3000
 - for Protec P3000XL: switching between HIGH FLOW and LOW FLOW mode
- in I•Guide mode:
 - navigation through I•Guide program (for all configurations)



Fig. 2-4 Probe handle

The probe handle also offers some LEDs in the flange of the sniffer tip in order to illuminate the location currently being leak tested.



Warning

Do not stare into the LEDs of the sniffer line intentionally for extended times or at a close distance as this may cause permanent damage to the eye.

The LEDs offer some bundled light. The intentional starring suspends the lid closing reflex and also the eyes do not move anymore which may lead to overheating of the retina.

When looking into the LEDs „incidentally“ the eye is protected by the lid closing reflex. Also the permanent movement of the eyes prevents overheating and consequent damage of the retina.

2.3.3 Built-in PRO-Check reference leak

A built-in PRO-Check reference leak is available for all Protec P3000. The PRO-Check reference leak can be used for verifying the correct functioning of the Protec P3000 including the correct calibration and can also be used for re-calibrating the Protec P3000 if necessary.

The PRO-Check reference leak is inserted in the front of the housing. Insertion of the sniffer tip into the cone-shaped test leak opening is automatically detected via a light barrier.



Fig. 2-5 Built-in PRO-Check reference leak



Fig. 2-6 PRO-Check reference leak detached from the main unit for remote use

In cases where the main unit is placed in a difficult or inconvenient to access area the built-in PRO-Check reference leak can be removed from the main unit for easier access and connected to the main unit via the Sub-D connector with a commonly available extension cord. The PRO-Check reference leak can then be placed in an area where it is convenient for the operator to be reached.



Fig. 2-7 Connections for remote use

Pos.	Description	Pos.	Description
1	Connector at built-in test leak	2	Connector at Protec P3000 housing

Notice The PRO-Check reference leak is not part of the Protec P3000 shipment and needs to be ordered as a separate part no. (see section [1.3.2 Accessories](#)).

Notice If you have not purchased the PRO-Check reference leak, warning 71 (“No communication with test leak”) will be issued on first start-up. Please go to SETTINGS / INTERFACES / PRO-CHECK and set the PRO-Check to “DISABLED” to prevent future warnings (see section [4.5.6](#))

Notice PRO-Check Warntime Expire Date (See Section 7.7.5).

3 Operation of the Protec P3000

3.1 Start-Up

Assemble the Protec P3000 (see Section 1.5). Connect the mains cord and the SL3000(XL) sniffer line, and then switch on the Protec P3000. The mains switch is located on the rear.

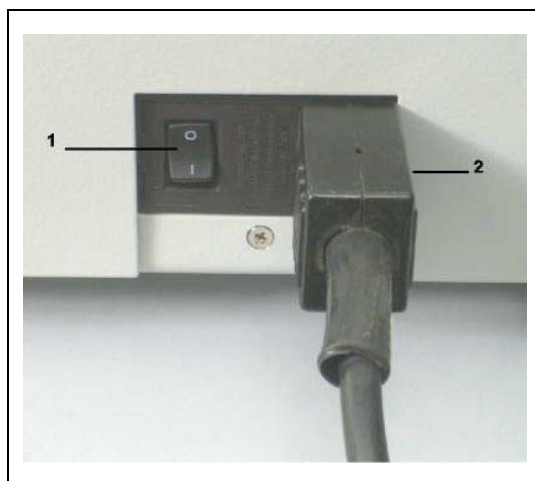

Fig. 3-1 Connection of the mains cord

Pos.	Description	Pos.	Description
1	Power Switch	2	Power cord connection

The Protec P3000 will automatically start-up without operator interaction. After power on the message "Wait for heater" will be displayed with the pump not being started yet. The foreline pressure as well as the flow through the sniffer line will be stated during this time.

After the pumps are switched on a self-test procedure will be performed during which all hardware will be checked. The message "wait for sensor current" will be displayed next. A bar graph will indicate the progress of this warm-up stage. The expected warm-up time left will be stated below the bar graph.

Notice The start-up procedure normally lasts 2 - 3 min. After extended times of power off, however, the start-up of the Protec P3000 may take up to 20 min. max. To improve the start-up behaviour of the Protec P3000 after extended times of power off, see Section 3.8.

After switching on and completion of the run-up phase the Protec P3000 will be ready to make measurements. There is no separate start function. The SL3000(XL) sniffer lines are designed to maintain an inlet pressure low enough to make measurements.

Notice The Protec P3000 will only operate after having connected the sniffer line. A calibration in accordance with Section 3.5 is recommended not before 20 minutes after having switched on the instrument (warm-up phase).

Notice If you have not purchased the PRO-Check reference leak, warning 71 (“No communication with test leak”) will be issued on first start-up. Please go to Settings / Interfaces PRO-Check and set the PRO-Check to “disabled” to prevent future warnings (see section 4.5.6).

3.2 Controls on the main display unit

All set-up and control functions are integrated into the main display unit via the menu structure. The functions of the 8 control keys are displayed on the LC display. During measurements the main interface is the probe handle display giving all necessary information for proper leak testing.

After start-up the Protec P3000 will automatically go into measurement mode.

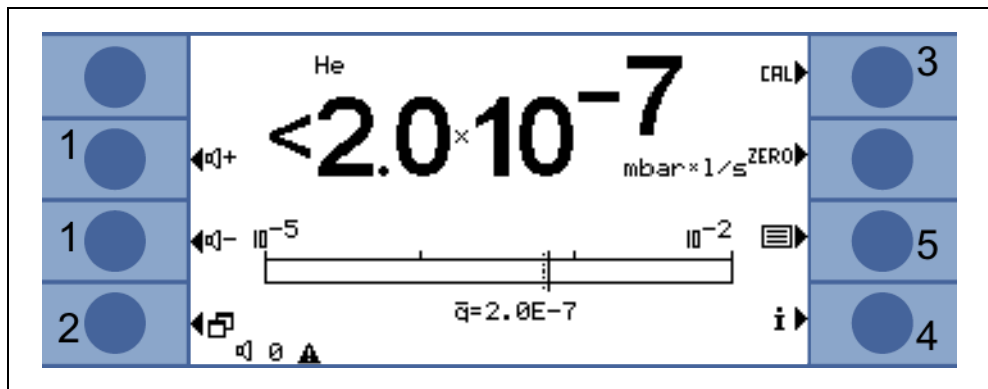

Fig. 3-2 Measurement screen

Pos.	Description	Pos.	Description
1	Audio volume buttons	4	Info button
2	Menu button	5	List of gas parameters buttons
3	Calibration button		

Bar graph display

The currently detected leak rate will be display in a bar graph in logarithmic scale. The currently selected trigger level is indicated by a black line, the currently selected search level is indicated by a dotted line. If the search level is exceeded the shape of a bell is displayed at the top of the display, if the trigger is exceeded the bell starts to blink (to ring).

Gas type (refrigerant equivalent)

The currently selected gas type (helium or refrigerant equivalent) is indicated on the upper left side of the display.

For P3000XL only:

If the Protec P3000XL is operated in HIGH FLOW mode, the gas type is displayed in inverted characters (on dark background) in the main display as well on the sniffer display.

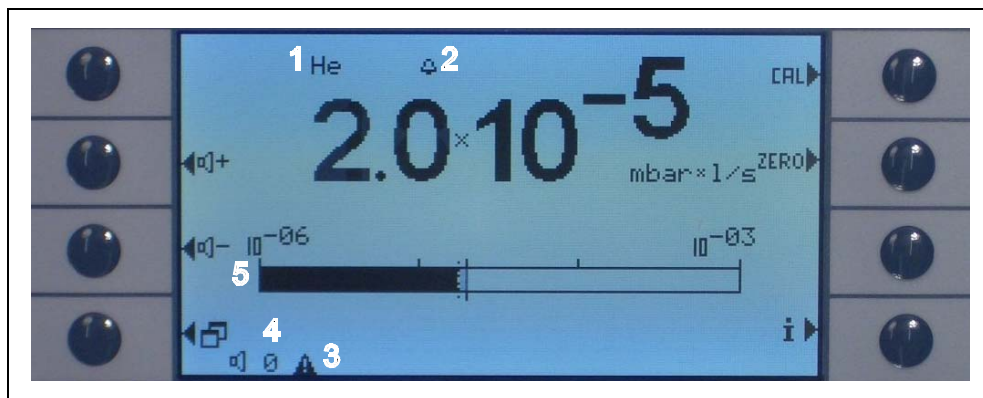

Fig. 3-3 Measurement screen with leak

Pos. Description

- 1 Selected gas type (refrigerant equivalent or He)
- 2 Indication of search level being exceeded
- 3 Indication of active warning
- 4 Audio volume level
- 5 Bar graph display of leak rate

Audio Volume Buttons

The two middle keys on the left side of the display allow to adjust the volume of the alarm sound at any time. When pressing any of the two buttons the currently selected volume will be demonstrated by the loudspeaker as well as by a bar graph in the status line. The selected value is also displayed as the first entry of the status line at the bottom of the display and only applies to the loud speaker in the main unit. For selecting different types of alarms see section [4.4.2](#).

Menu Button

The  button on the bottom left side of the display will open the main menu at any time. The menu mode offers the user many possibilities of entering instrument settings and special functions.

CAL Button

With the button on the upper right side of the display an external calibration of the Protec P3000 can be started at any time. For details on how to perform an external calibration see Section [3.5.3](#).

ZERO Button

When shortly pressing the zero button, the zero level will be updated. For details on the ZERO function see Section 4.4.1.

List of gas parameters button

Up to four different gas parameter sets can be stored in the Protec P3000. If more than one set of gas parameters are set-up, the list button on the right side of the display will appear in the menu screen. When pressing this button, a new set of gas parameters (e.g. different refrigerant equivalent, different trigger level, etc) can be selected. For details on how to set up the different gas parameters see section 4.3.1.

Info Button

When pressing the **i** info button (bottom right side of the display) information on the status of the Protec P3000 will be displayed. For details see section 3.4.3.

Status Line

In the bottom line of the main display status information is indicated. First the currently selected volume for the audio alarm is stated. Next, a small black triangle with an exclamation mark may indicate an active warning.

Lock Softkeys

The keys CAL, ZERO und  can be locked. So the settings of these functions can be protected.



Abb. 3-4 Function key

3.3 Controls on the probe display unit

On the display of the probe handle similar information as on the main display is shown.

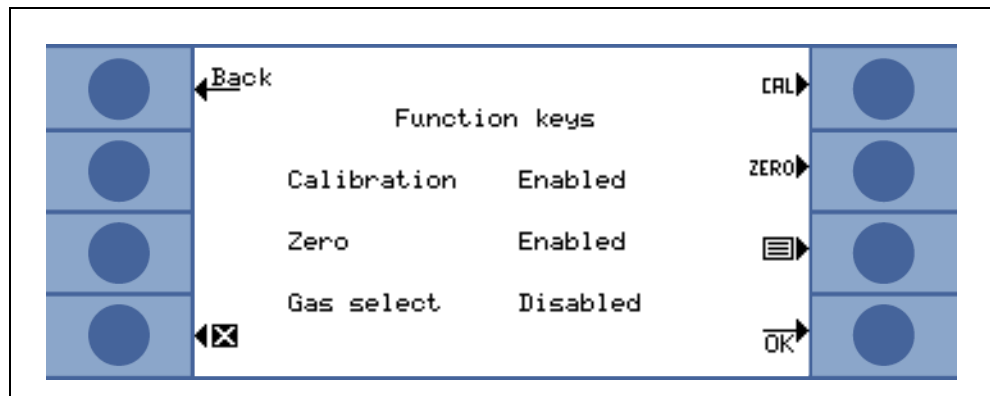

Pos.	Description
1	Bar graph indicating the leak rate
2	Absolute leak rate
3	Gas equivalent

Fig. 3-5 Sniffer display in standard operation mode

The currently detected leak rate is indicated as a bar graph. In a second line the numerical leak rate (in the same unit of measurement as on the main display) is shown. In the third line the type of gas equivalent is stated (e.g. He or R134a).

For Protec P3000XL only:

If the Protec P3000XL is operated in HIGH FLOW mode, the gas equivalent is displayed in inverted characters (on dark background).

The sniffer probe offers two press buttons. By pressing the left button the current background reading is set to ZERO. For details on the ZERO function please refer to [4.4.1. ZERO](#).

The right probe button is used for navigation when working in **!Guide** mode (see [Section 3.4.2](#)) or for starting an internal calibration (see [Section 3.5.2](#))

3.4 Performing measurements

The Protec P3000 offers two modes of operation:

- The Standard Operation Mode (compatible to the Protec mode)
- The **!Guide** Operating Mode



Warning

Danger of electric shock.

Don't touch voltaged parts with the sniffer tip. Test samples need to be disconnected from electricity before leak testing.

Standby Function

The Protec P3000 offers a STANDBY function to prevent the needless intake of contaminants into the sniffer probe during idle times, thus saving filter and sensor life time.

The Protec P3000 may automatically go into standby after a preset time of inoperation (see Chapter 4.3.1 for details on how to set-up this function) and operation will automatically resume if the probe is picked up again.

The Protec P3000 can also be set into STANDBY mode manually by pressing the left probe button for 2 seconds. If the Protec P3000 has been set into STANDBY mode manually operation will only resume by pressing any of the two probe buttons again.

Operating in moist environment



Caution

Do not suck in any liquids.

For operation in an environment where moisture (e.g. condensating water) may occur, a water-protection tip is available (Cat. no. 12246) which will protect the Protec P3000 against intake of liquids if necessary. For details on how to install the water protection tip see 1.6.2)

Protection mode and high helium background

The Protec P3000 is equipped with a protection mode against contamination with huge amounts of helium. This contamination mode will help the leak detector to clean up faster after detection of gross leaks.

If the Protec P3000 switches to GROSS MODE the item „GROSS“ is displayed and an acoustic signal is to hear.

If a huge amount of helium is detected the Protec P3000 may show the message HELIUM CONTAMINATED. The leak detector will come back to measurement mode automatically after clean up and the displayed item „GROSS“ disappears.

Notice The Protec P3000 should not be switched off or set to STANDBY mode while HELIUM CONTAMINATED is displayed as this will trap the increased levels of helium inside the sensor and it cannot be pumped away for clean up of the Protec P3000. Switching off the Protec P3000 while contaminated with large concentrations of helium will in fact lead to significantly increased start-up times afterwards. If this has happened unintentionally, just switch on the Protec P3000 and let it sit in "Warm up" until it reaches measurement mode.

Notice In HIGH FLOW mode leak rates in the range $< 1 \times 10^{-5}$ mbar l/s are reduced during a time of 30 Sec. to the current background value.

For details on how to set up the CONTAMINATION LIMIT please refer to Section 4.4.1.

3.4.1 Standard Operation Mode

Provided the Protec P3000 has been set-up to meet the requirements of the particular application and it has been calibrated (see Section 3.5), a measurement is performed as follows:

First briefly operate the ZERO button on the sniffer probe. This will ensure that the Protec P3000 eliminates all interfering influences which may affect the ZERO level (i.e. the detection limit of 1×10^{-7} mbar l/s). Next hold the tip of the sniffer as close as possible to the suspected leak, if required the tip may even touch the test object. If a welded seam or alike needs to be tested, the tip should be moved at a velocity of no more than 13 cm/s (5 inch per second) along the welded seam. The distance between tip and test sample should be as small as possible.

If a leak is detected the bar will grow. The Protec P3000 continuously compares the measured leak rates with the programmed trigger levels. If the trigger is exceeded the background colour of the probe display will change from green to red. At the same time an alarm sound will be released by the speaker in the probe handle and the probe handle will start to slightly vibrate. As an additional indication of exceeding the trigger value the three white LEDs in the flange of the sniffer tip will start flashing.



Fig. 3-6 Sniffer display when detecting a leak

As soon as an acoustic alarm sounds, the tip should be removed from the spot being tested. After displaying a constant leak rate the ZERO button should be pressed again to repeat the test. Thus, a measurement error can be prevented and the leak can be located.

For Protec P3000XL only:

The Protec P3000XL allows the use of the HIGH FLOW mode (requires use of SL3000XL sniffer line). When set to HIGH FLOW mode leaks may be detected at a larger distance from the potential leak. The high flow mode is indicated by the gas type being displayed in inverted colors (on the probe display as well as on the main display). When testing for joints, the sniffer tip should be no further than 10 mm (0.4 in) away from the joint. If testing a welded seam (or alike), the sniffer tip should not be moved faster than 4 cm/s (1.6 in/s) at a maximum distance of 10 mm (0.4 in) from the welded seam.

If a leak is detected (and accessibility allows so) switch the Protec P3000XL to LOW FLOW mode (by pressing the right probe button) for easier localization of the leak. The gas type will now be displayed not-inverted. Now search for the leak again by bringing the sniffer tip as close as possible to the potentially leaking area. Localize the leak by moving the sniffer tip back and forth across the suspected area. The leak will occur where the leak rate signal shows the maximum leak rate.

3.4.2 I•Guide Operating Mode

The I•Guide operating mode has been introduced to support the operator in applying proper sniffer leak detection technique.

The I•Guide operator guiding mode allows to store pre-programmed parameters for different units under test. The number of locations that need to be tested per specimen, the time each location needs to be tested for as well as the time required to move to the next location may be programmed. In addition, a maximum allowable global leak rate for the total unit under test is stored. In the I•Guide mode up to 10 pre-programmed testing procedures can be stored.

Notice If the number of locations to be tested is set to zero, the Protec P3000 will operate in a continuous mode without checking for a global leak rate but still issue the timer signal for proper testing.

3.4.2.1 Starting the I•Guide Mode

To start the I•Guide Mode go to the main menu and choose SET UP I•GUIDE. In the opening menu go to the top line item and change the setting to ON with the left hand side push button and press OK. The Protec P3000 will automatically choose the first enabled I•Guide program in the list. A message screen will pop-up notifying the operator that I•Guide has been activated (the gas selected in the I•Guide program you choose).

For how to set-up and I•Guide program please refer to Section 4.4.4.

To switch back to the Standard Operation Mode select "OFF" and press "OK".

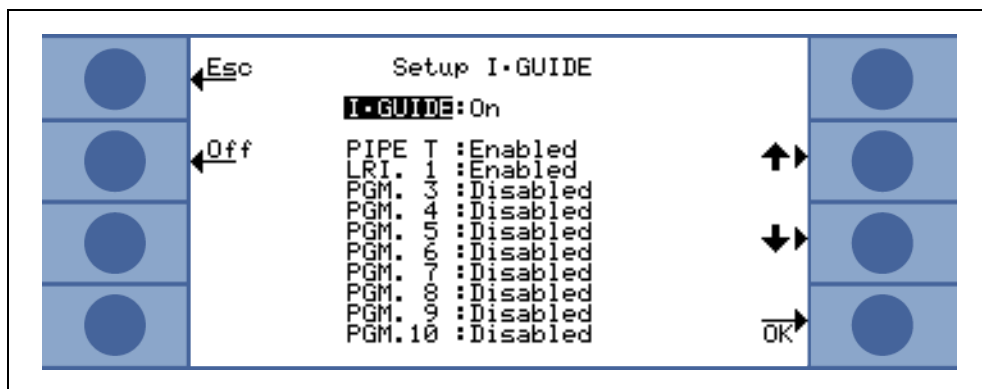

Fig. 3-7 Switching to I•Guide Mode

3.4.2.2 Selecting an I•Guide Program

To open the SELECT I•GUIDE menu press the PROGRAM LIST button on the right side of the display.

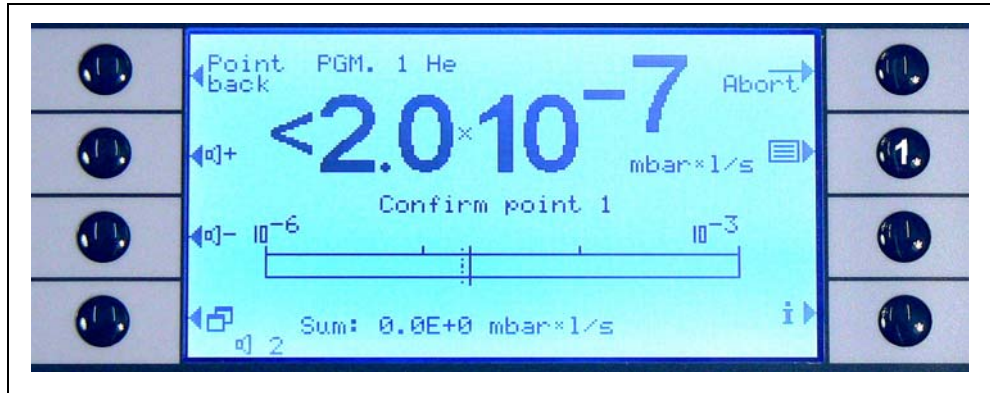

Fig. 3-8 Measuring Screen in I•Guide Mode

Pos. Description

1 Program list

In the opening SELECT I•GUIDE menu highlight the program number you intend to use and press ok. The new program is now loaded.

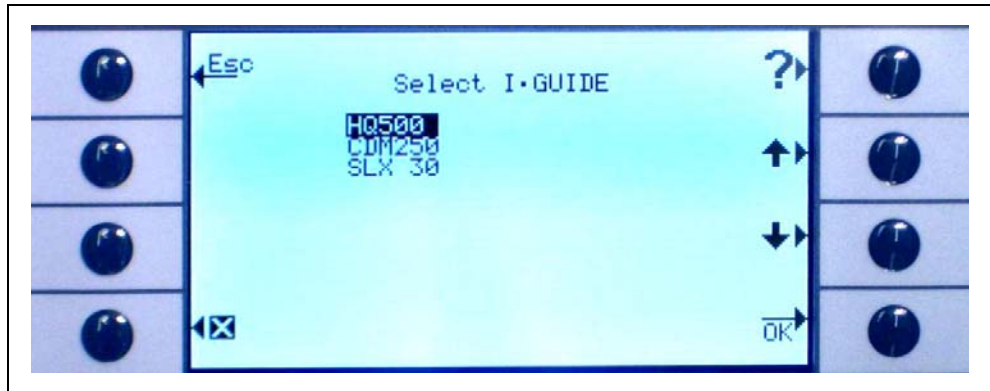

Fig. 3-9 Selecting an I•Guide program

3.4.2.3 Using an I•Guide Program

In the measuring screen of the I•Guide operating mode the selected program, the gas type stored in the program as well as the summarized global leak rate will be displayed.

For Protec P3000XL only:

If the Protec P3000XL is operated in HIGH FLOW mode, the gas type is displayed in inverted characters (on dark background) in the main display as well as on the sniffer probe display.

For all Protec P3000 configurations

In the I•Guide message line the Protec P3000 will prompt the user for action. First it will ask to move to the first testing position. Also on the probe display the message “okay pos. 1?” will be shown. Please confirm with the right probe button that the sniffer tip has reached the right location.

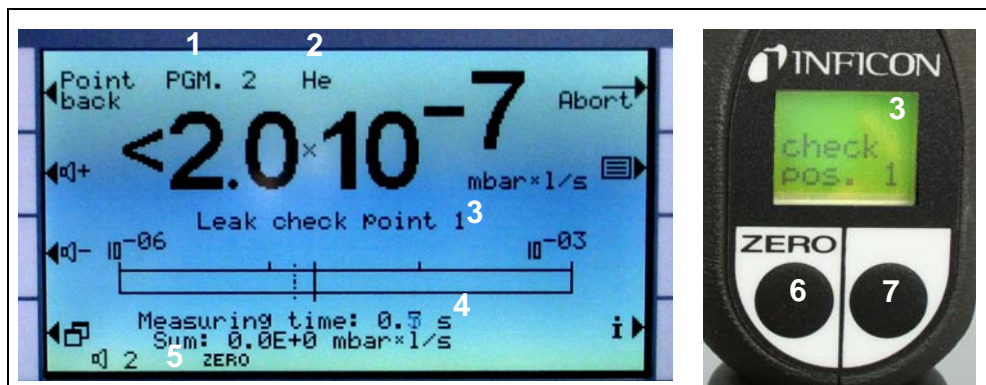

Fig. 3-10 I•Guide screens during measurement

Pos. Description

- 1 Selected program
- 2 Gas type stored in the selected program
- 3 I•Guide message
- 4 Measuring time
- 5 Summarized global leak rate per unit under test
- 6 ZERO button
- 7 I•Guide button

After the first location has been confirmed the message “leak check point1” will be indicated on the main unit display and the elapsing measurement time (stored in the testing program) will be shown in the lower part of the menu page. Please make sure to hold the sniffer tip in the right testing location during the total measuring time. During this time a ticking sound will be issued by the main unit and a beep will indicate that the measuring time has elapsed and the sniffer tip can be moved again.

After the measurement time has elapsed the message “Move to point 2” will be displayed on the main unit. The Probe display will read “tip to pos. 2”. Please move the sniffer tip to the next testing location and if the wait time indicated in the display has elapsed you may start the next measurement. If the operator tries to start the next measurement before the wait time has elapsed, the message “please wait” will be displayed in the message line until a next measurement is allowed. Please confirm that the sniffer tip has been positioned properly by pressing the right probe button so that the next measurement can be started.

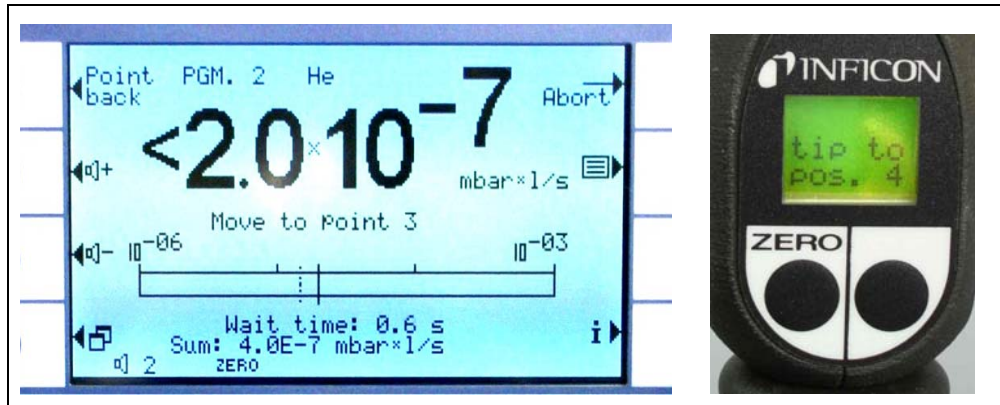

Fig. 3-11 •Guide screens requesting the next location

After checking the pre-programmed number of locations the result of the testing for the total unit under test will be displayed as shown in the following screen shot. The selected testing program as well as the gas type stored in the program will be stated once more followed by the summarized global leak rate. If the global leak rate is lower than the global leak rate trigger the message “Global leak check okay!” will be displayed followed by the testing results for each tested location.

Notice For each location where no leak is detected, the currently selected lower display limit is added to the global leak rate as this is the maximum leak rate which still may occur for each position (worst case approach).

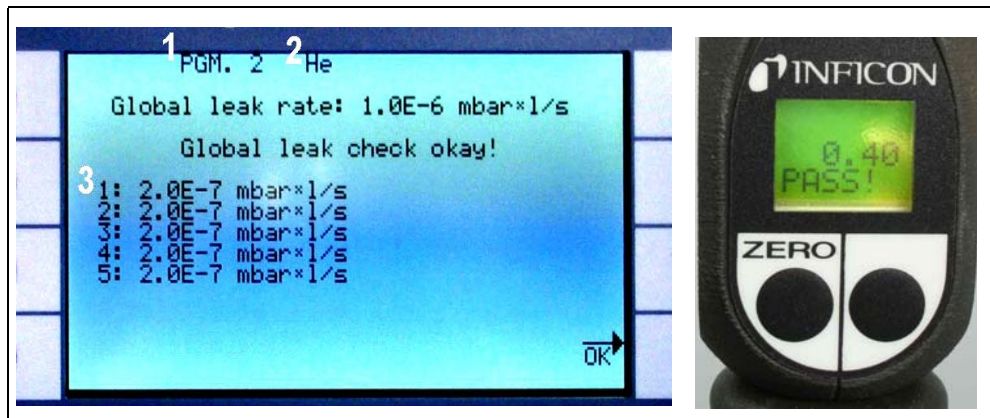

Fig. 3-12 Result of •Guide program: unit under test passed

Pos.	Description	Pos.	Description
1	Program name	3	Results of each location tested
2	Gas type		

If the summarized global leak rate exceeds the global trigger the message “Global trigger exceeded!” will be displayed.

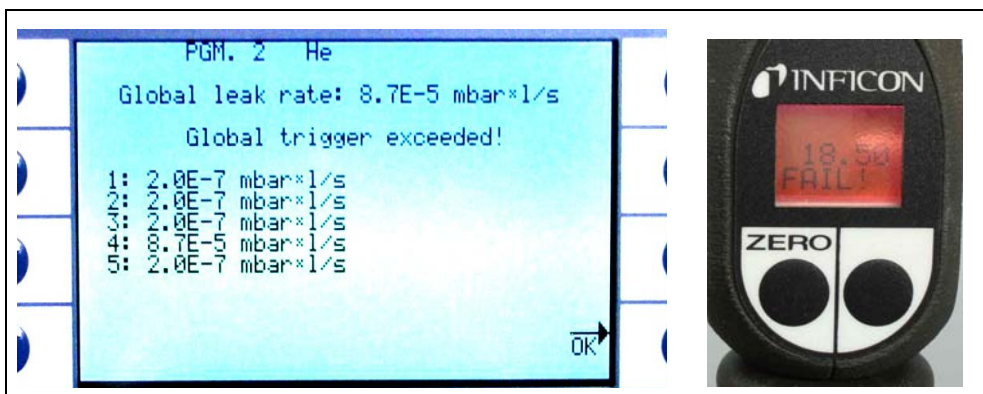

Fig. 3-13 Result of I•Guide program: unit under test failed

By pressing the right probe button the next testing cycle may be started.

Notice The I•Guide mode can also be used as a timer signal only. If the number of points is set to 0, the Protec P3000 will prompt for the next location to be tested continuously without using the global leak rate function.

Notice The I•Guide mode can also be used to summarize leak rates on demand. If the number of points is set to 99, a results screen with summarized global leak rate will be displayed after the right button has been pressed for 2 s continuously (or after the 98th point automatically).

3.4.3 The Info Page

By pressing the info button on the main display a general info page will open. Information on the software version used, date & time information, the currently set audio volume and the minimum audio volume are stated.

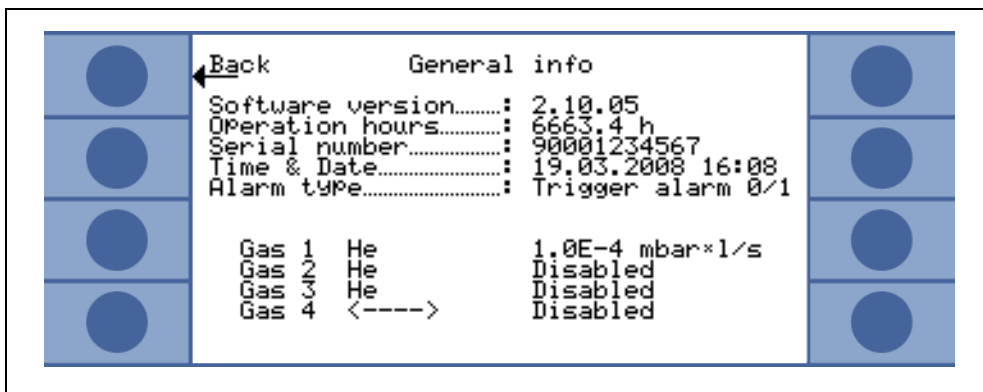

Fig. 3-14 Info page without errors or warnings

If an active warning exists this will be displayed in the info page instead of the gas info lines.

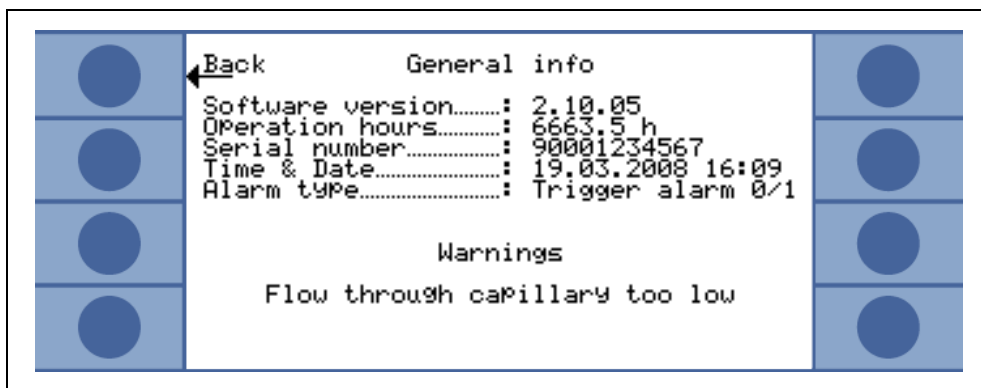

Fig. 3-15 Info page with active warning

When operating in I•Guide Mode, the info page will state information about the currently selected program: the selected program name, the gas used for this program, the number of points to be checked for this program, the selected measuring and wait time as well as the global trigger.

3.5 Calibration and Self-Test

The Protec P3000 can be calibrated internally with the built-in PRO-Check reference leak or externally with an external calibrated leak (Cat. No. 122 37 - 122 39).

Notice If a calibration is started during the first 20 minutes after power on, a warning will be issued.

Do not calibrate the Protec P3000 during the first 20 minutes after start-up. Also a verification of the calibration may lead to wrong results in the first 20 minutes after start-up.

Only confirm and continue with the calibration if the real warm-up has been longer than 20 min. (e.g. after a quick restart of the Protec P3000.)

The built-in PRO-Check reference leak can be used for a self-test of the Protec P3000 as well as for internal calibration.

Notice The PRO-Check reference leak is a temperature compensated leak. It must only be used when electrically connected to the main unit, either when inserted into its port or when connected to the main unit via a Sub-D extension cord. The leak rate printed onto the body of the PRO-Check is only valid at 20°C (68F) and will vary greatly with temperature and time.

To compensate for this the PRO-Check reference leak is equipped with a temperature sensor and a compensation curve is stored in the software which automatically compensates the test leak rate for changes in temperature when connected to the main unit.

A calibration or verification with the PRO-Check reference leak not being connected to the main unit will cause a wrong calibration of the Protec P3000 and / or will lead to wrong testing results.

3.5.1 Verifying a calibration (proof function)

Notice A verification can only be performed while the unit is in one of the two measurement modes: standard operation mode or I•Guide operation mode. A verification will not be started if the main menu is opened.

If the sniffer tip is inserted into the opening of the PRO-Check reference leak a verification of the calibration (proof function) will be started automatically. While holding the sniffer tip in the test leak opening, the unit will check the reading from the PRO-Check. Afterwards the operator will be requested to remove the sniffer tip from the leak opening.

Notice Any time during the verification procedure an internal calibration may be started by pressing either the right sniffer probe button or the CAL button on the main display.

The results of the verification will be displayed in a summarizing screen. If the verification process was successful, the message "sensitivity check OK" will be displayed.

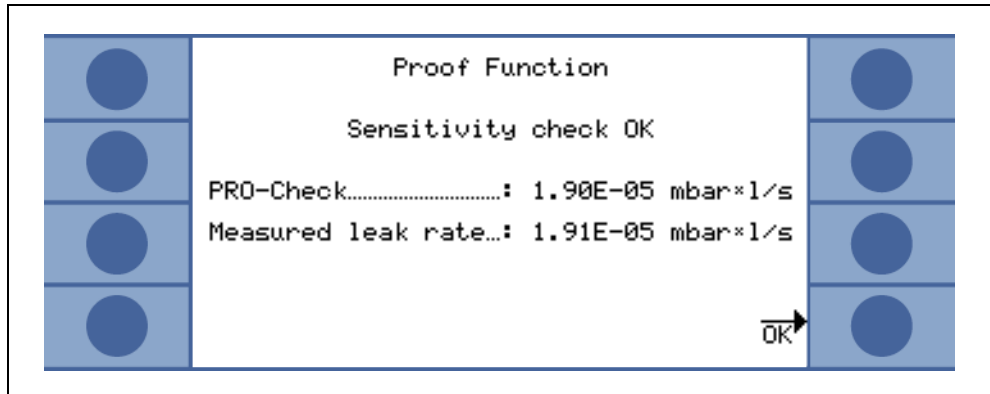

Fig. 3-16 Results of proof function for Protec P3000

If the value measured for the PRO-Check is out of range, the message "recalibration required!" will be displayed in inverted colors.

For returning to the measuring mode, please press the right probe button or press "OK" on the main display.

For Protec P3000XL only

For the Protec P3000XL both calibration factors for HIGH FLOW and LOW FLOW mode will be verified (see fig. 3-16). However, only the information for the selected flow mode will be relevant for passing or failing the verification. The results for the non-selected mode will be displayed for reference at the bottom of the results screen.

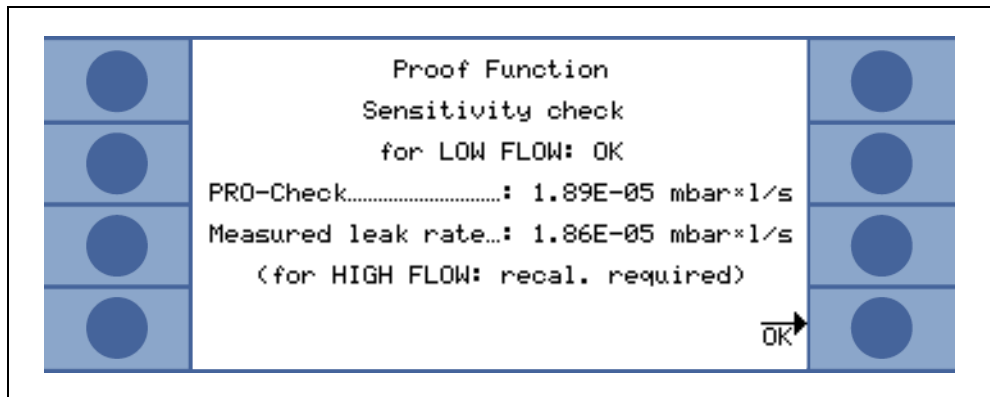

Fig. 3-17 Results of proof function for Protec P3000XL

3.5.2 Internal calibration

Notice A calibration can only be performed while the unit is in one of the two measurement modes: standard operation mode or I•Guide operation mode. A calibration will not be started if the main menu is opened.

If the sniffer tip is inserted into the opening of the PRO-Check reference leak with the right probe button pressed while in measurement mode a calibration will be started automatically. While holding the sniffer tip in the test leak opening, the Protec P3000 will measure the test leak. Afterwards the operator will be requested to remove the sniffer tip from the leak opening.

After completion of the internal calibration a screen summarizing the results of the calibration will be displayed. The old calibration factor as well as the new calibration factor will be displayed. If warnings are active and have been acknowledged during the calibration process, the message is endorsed with the information "with active warnings".

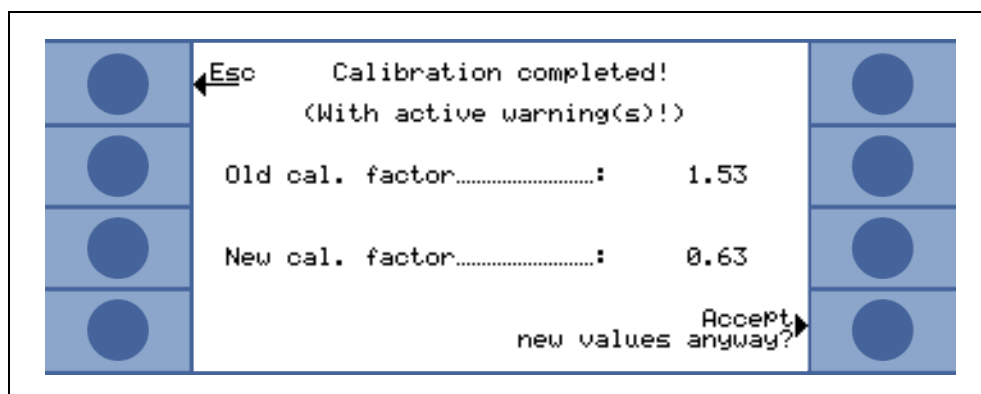

Fig. 3-18 Results of internal calibration

To avoid unintended overwriting of a previous external (more accurate) calibration, the operator needs to "Accept new values (anyway)?".

3.5.3 External calibration

For external calibration it is recommended to use leak rates $> 5 \times 10^{-6}$ mbar l/s for Protec P3000 and leak rates of $> 5 \times 10^{-5}$ mbar l/s when calibrating the Protec P3000XL at HIGH FLOW (3000 sccm).

If the reference leak rate is $< 5 \times 10^{-5}$ mbar l/s the Protec P3000XL automatically calibrates in LOW FLOW mode.

Notice If significantly increased backgrounds are prevalent in your production environment, larger leak rates for the calibration leak may be required.

The external calibration is a semi-automatic process during which the user will have to follow some instructions. The calibration process may be started via the "CAL" - button from the measuring mode at any time (except when the menu is open or the function has been locked). A running calibration process may be cancelled by operating the "ESC" button.

After pressing the CAL button, please check whether the leak rate equals the leak rate of the external leak you plan to use. If the leak rate is different press EDIT LEAK RATE and enter the correct leak rate value. Press "START" afterwards to begin with the calibration process.

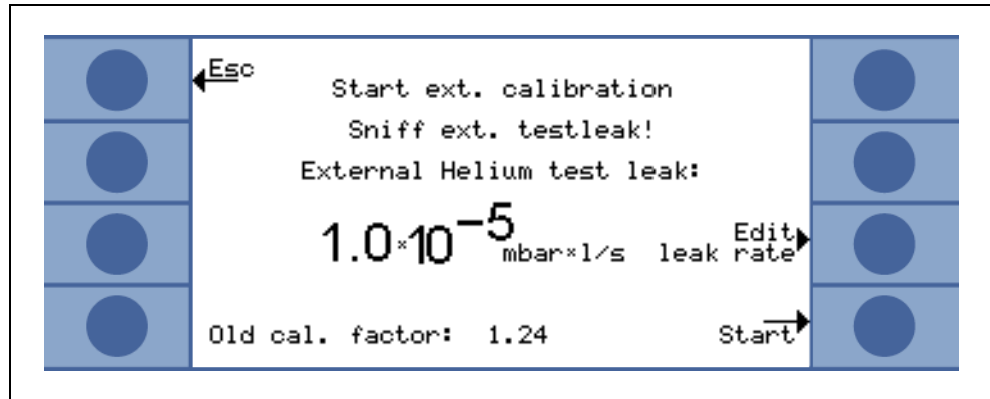

Fig. 3-19 Setting-up the leak rate of the external leak

Please hold the sniffer tip to the outlet of the external calibrated leak. Hold the sniffer tip steady and very close to the opening, however, do not clog the opening with the sniffer tip. Some air also needs to enter the sniffer tip in addition to the helium from the external calibrated leak. If the leak rate signal indicated by the bar graph is stable press "OK". Keep holding the sniffer tip steady in front of the opening while the Protec P3000 reads the leak rate of the calibrated leak. During this time the text "Please wait..." will be displayed.

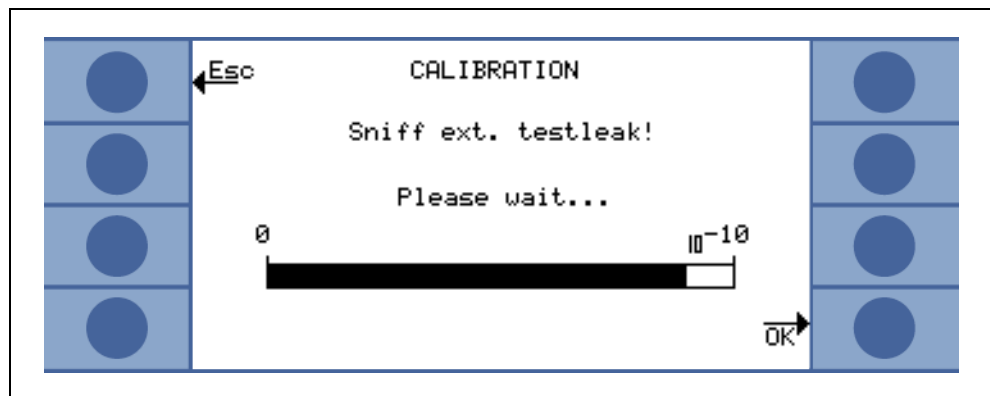

Fig. 3-20 Calibration screen during external calibration

When the analysis of the calibrated leak signal is completed a message "sniff air!" will be displayed. Remove the sniffer tip from the opening of the calibrated leak and hold the sniffer tip into the air, as far as possible from any sources of helium. Wait until the bar graph shows a stable signal again and press "ok" once more.

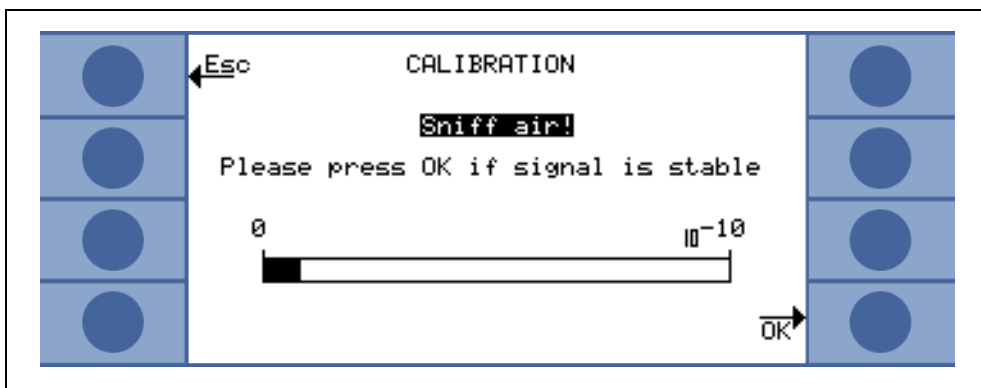

Fig. 3-21 Request to sniff air during external calibration

A message "Please wait..." will be displayed until the calibration is finished.

After completion of the external calibration a screen summarizing the results of the calibration will be displayed. The old calibration factor as well as the new calibration factor will be displayed. If warnings are active and have been acknowledged during the calibration process, the message is endorsed with the information "with active warnings".

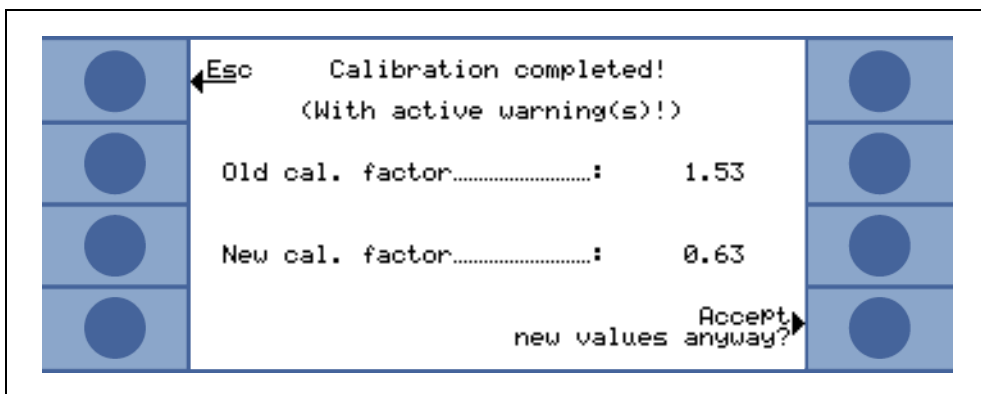

Fig. 3-22 Results of external calibration

3.6 Standby

If not used, the Protec P3000 will go into a STANDBY mode automatically after a predetermined time in order to avoid wear of parts during times not used. In this STANDBY mode the flow through the sniffer line will be shut down to conserve filters in the sniffer line as well as to save sensor life time.

If the operator picks up the sniffer line, a movement sensor will detect this action and will set the Protec P3000 back into normal operation. The Protec P3000 will be ready for measurement again after approx. 5 seconds.

For details on how to set the time until the Protec P3000 goes into STANDBY mode please refer to section 4.3.1 (VACUUM & ACCESS, STANDBY DELAY)

3.7 Shutdown

To shut down the Protec P3000, set the ON / OFF main switch (Fig. 3-1/6) to the „0“ position regardless of the operating mode of the Protec P3000. Nothing else is required. The parameters entered are saved by Protec P3000. After switching on, the Protec P3000 will revert to the same status it was in when it was switched off before.

3.8 Storage for fast availability as back-up unit

Due to accumulation of Helium (from air) in the sensor unit during storage the start-up time for the Protec P3000 will be approx. 1.5 min per day of storage with a maximum start-up time of approx. 1 hour.

If you want to use the Protec P3000 as a back-up unit to ensure uninterrupted availability of your production line, the Protec P3000 should be stored as follows.

- 1** Shut down the Protec P3000 but keep it connected to a power outlet.
- 2** Put a clock timer between the Protec P3000 and the power outlet.
- 3** Program the clock timer to switch on the Protec P3000 for 1 hour twice per week (at least every 4 days).

Notice The clock timer should be battery buffered so that in case of a loss of power in the factory, the clock timer does not lose its pre-programmed window for power on.

With this approach the max. start-up time will be approx. 7 min.

4 Equipment Settings

4.1 Menu Structure

By pressing the menu button the main menu page opens. The following options will be displayed:

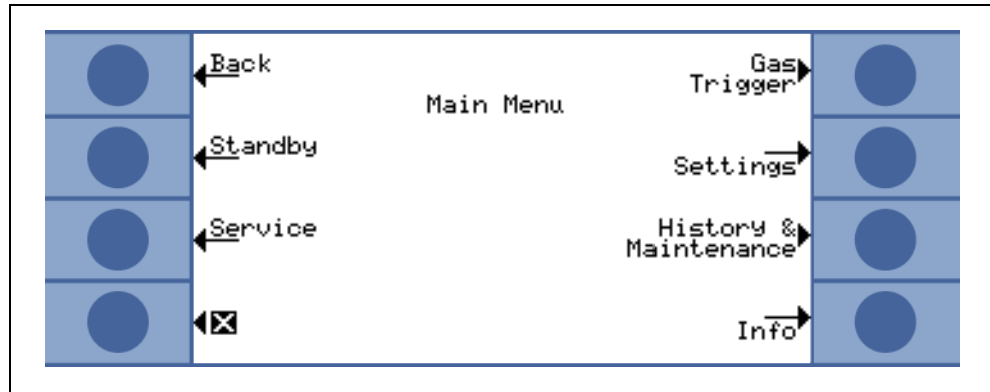

Fig. 4-1 Main menu screen

In the subsequent sub-menus the following frequently used functions will occur:

- ↑↓ The “up” and “down” keys allow scrolling through listed menu items. The currently selected menu item is highlighted by inverted colours. The “up” and “down” keys are also used for changing numerical values to a new setting.
- ? Help function – by pressing this key additional information on how to use this page can be displayed.
- Esc** Going back to the previous page while omitting any changes.
- Back** Going back to the next higher level in the menu structure.
- OK** Accepting a selected item from a list or accepting newly entered values.
- X** Exit all menus and return to main screen. If the menu button is pressed later on again, the software will jump to the menu page that has been exited by the **X** button. By pressing the back key the display will go back one level and finally all the way back to the measurement display page.

The menu structure of the main menu is illustrated on the following page for quick reference.

Main menu	Standby/Start			Library Gas
	Service			User Gas
Gas Trigger	Gas 1	Gas 1	Name (edit)	Helium
	Gas 2	Gas 2	Additional He	
	Gas 3	Gas 3	Mode	
	Gas 4	Gas 4	Trigger&Unit	
			Display limit	
			Search level	
			Equivalent correction (He)	
			Zero time	
			Contamination limit	
			Flow limits (only P 3000)	limit LOW FLOW
Settings	Vakuum & access			limit HIGH FLOW
				Additional low flow error
				Flow mode
				Limits low flow error
				Sniffer button
				Standby delay
				CALibration
				Change menu-PIN
		Audio		Beep sound
				Audio intern
			Audio Sniffer	
			Alarm type	
			Volume	
	Setup I-Guide		I-Guide ON/OFF	
			Meas. 1...10 (edit)	Name
				Gas
				No. of points
				Measuring time
				Wait time
	Miscellaneous			Global trigger
		Language		
		Time & date		
		PRO-Check Warrtime Expiry Date		
		Pressure unit		
		Leak rate filter		
		Alarm delay		
		Sniffer light		
Display			Contrast	
			Peak hold	
		Flow Display (1)		
		User mode		
		Lock Softkeys		
Interfaces		Control location		
		Recorder outputs		
		Select PLC inputs		
		RS232 protocol		
		Baud rate & End sign		
History&Maintenance		PRO-Check		
	View error list			
	Calibration history			
	Sniffer tip filter			
	Maintenance intervall			
	Maintenance history			
	Confirm maintenance (1)		(1) only in user mode "Advanced mode"	
Replace PRO-Check (1)				
Info	General data			
	Sensor Global			
	Sensor Errors			
	PRO-Check data			
	Sniffer line data			
	I/O-Port data			
	Analog data			

4.2 The Service Menu

The service menu is password protected. When entering the service menu a PIN is required to be entered. The service menu should only be used by trained service personnel. The PIN for entering the service menu will be distributed during service training. Please refer to the service documentation for the submenus and functions of the service menu.

4.3 Selecting gas equivalents and setting trigger values

The Protec P3000 can detect leak rates as helium leak rates or in refrigerant equivalent leak rates. Up to four different sets of parameters can be stored by the Protec P3000. Only one type of leak rate, however, will be displayed in the measurement screen optional with the equivalent Helium leak rate in addition. In the gas / trigger menu the chosen gas equivalents are displayed with their current trigger value.

With default settings only helium is set up in the first set of parameters. The remaining three sets are blank ("<----->"). Only sets that have been edited will be listed in the list of gas parameters that can be loaded directly from the measuring screen through the list button.

4.3.1 Setting gas parameters

When pressing one of the GAS1 to GAS4 buttons an info page regarding the chosen set of parameters will open. Parameter sets that are not in use are marked blank („<----->“). Changes to the current setting can be made by scrolling to the line item to be changed by use of the UP and DOWN keys and selecting the line item by pressing the EDIT key.

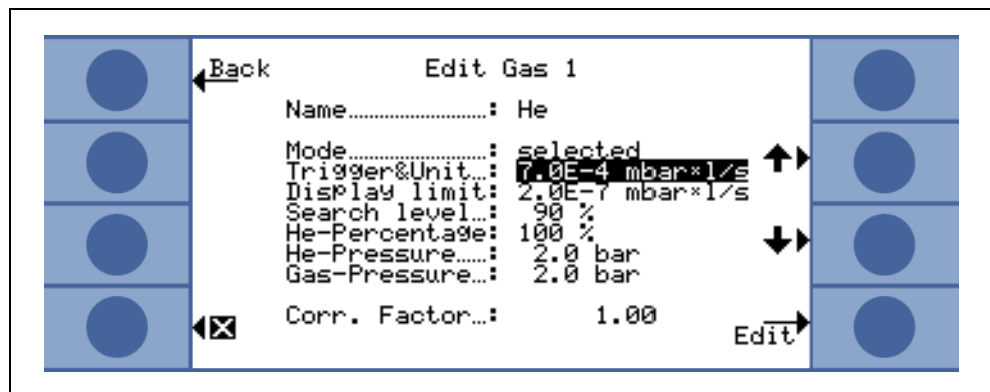

Fig. 4-2 Editing Gas 1

In the opening info page the name of the gas equivalent (or helium), the measurement mode and the currently selected trigger value will be displayed. This info is followed by the value for the lower display limit. In addition, the correction factor, the helium concentration used, the fill pressure for helium and the fill pressure for refrigerant later on are listed.

Name
(Gas equivalent)

For displaying the leak rate in refrigerant equivalent leak rates go to the EDIT GAS sub menu and go to the NAME line item. Press the EDIT button and in the opening GAS SELECTION submenu choose the refrigerant equivalent from the GAS LIBRARY. Gas parameters can be fully deleted by setting the gas name back to blank („<---->“).

Notice If more than one set of parameter is set up (i.e. maximum two gases are not named „<---->“) a list button will appear on the right side of the measurement screen. When pressing the list button a short-cut to selecting the different parameter sets will be provided.

Additional Helium

This submenu only is available when operating in gas equivalents. In this case the Protec P3000 may display the Helium leak rate in addition to the refrigerant equivalent leak rate in the main measurement screen. This feature may be selected or not selected.

Default: not selected

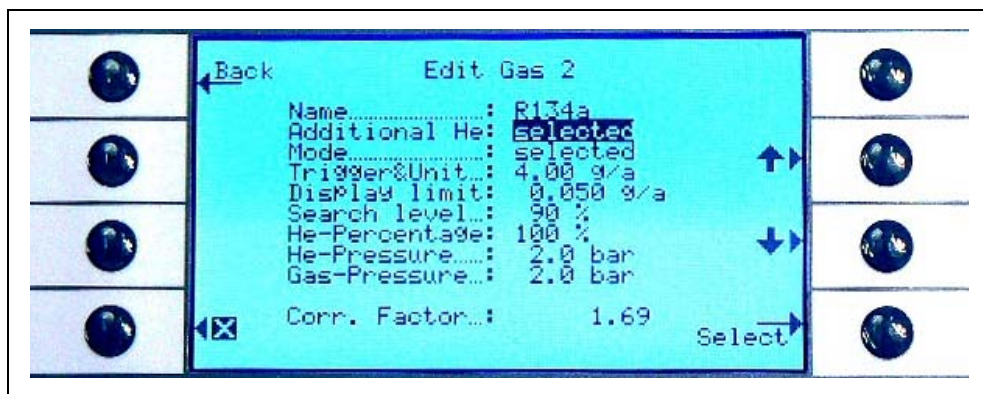

Fig. 4-3 Selecting additional Helium

Notice The option “Additional He” is only available if at least one parameter set (gas 1 ... gas 4) is configured to helium.

The additional helium will be displayed in the unit of measurement of the lowest gas number set to helium.

Editing gas equivalent parameters

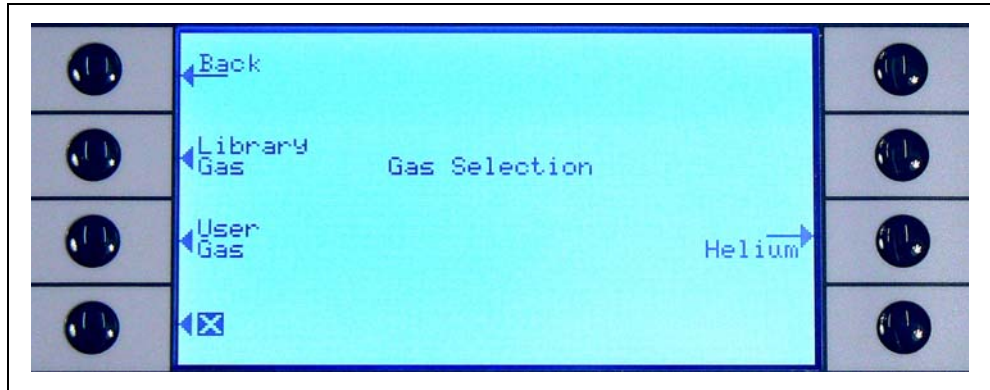

Fig. 4-4 Selecting gases from the library

Back in the edit gas submenu scroll to the HELIUM PERCENTAGE line item and press EDIT.

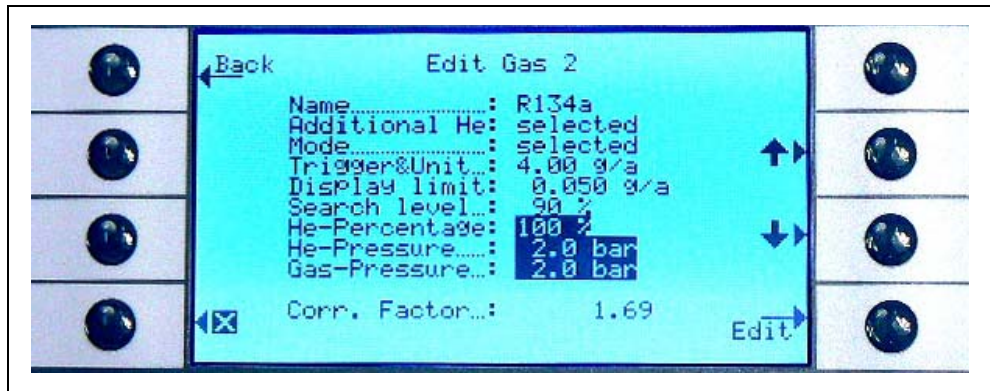

Fig. 4-5 Setting a refrigerant equivalent correction factor

In the opening submenu the helium fill pressure, the fill pressure for the gas equivalent (refrigerant) later on and the concentration of helium used can be entered. In the lower right corner the CORRECTION FACTOR (from helium to refrigerant) will be displayed. If a set of parameters is entered that exceeds the boundaries of the Protec P3000 the correction factor will be displayed in inverted colours. In this case adjust the parameters until the correction factor is displayed in normal colours again. Press OK if all parameters are as desired.

Notice This menu should also be used when working with diluted Helium but still displaying the leak rate as a Helium leak rate.

Notice This menu should be used at any time when the Helium fill pressure in pre-testing differs from the refrigerant fill pressure later on to display the correct leak rate value, even if the leak rate is still displayed as a Helium leak rate.

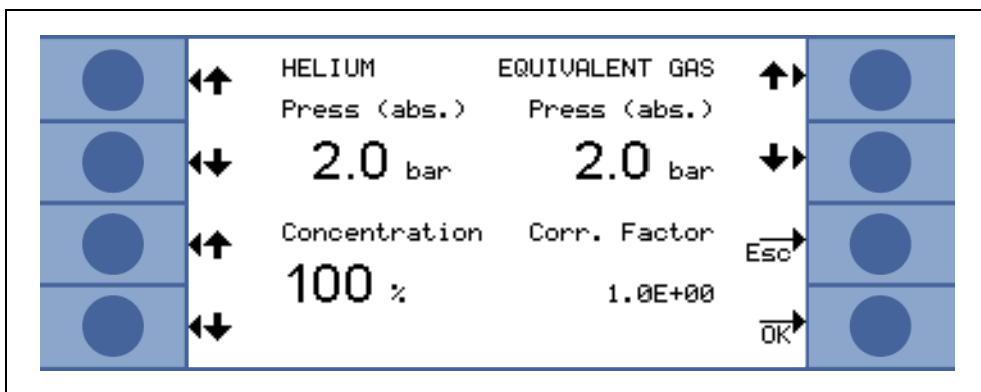

Fig. 4-6 Editing parameters for refrigerant equivalent leak rates

In the EDIT GAS submenu you can now enter the TRIGGER value in the refrigerant equivalent value.

A set of parameters (refrigerant type, fill pressure, helium concentration) can also be saved as user gas.

In the measurement screen the gas type will now be displayed as refrigerant equivalent leak rate (e.g. R134a <- He).

Trigger and unit of measurement

In the EDIT GAS X info page the TRIGGER & UNIT sub-menu page will open by selecting the corresponding line item. You can change the trigger level setting by the use of the left UP and DOWN keys. The correct settings must be confirmed by the OK button. You can leave the submenu without making any changes by using the ESC key.

The leak rate unit can be changed by the use of the right UP and DOWN keys, Available leak rate units include mbar l/s, Pam³/s, Torr l/s, atm cc/s, g/a, oz/yr, lb/yr, ppm.

Default value: 2 x 10⁻⁵ mbar l/s

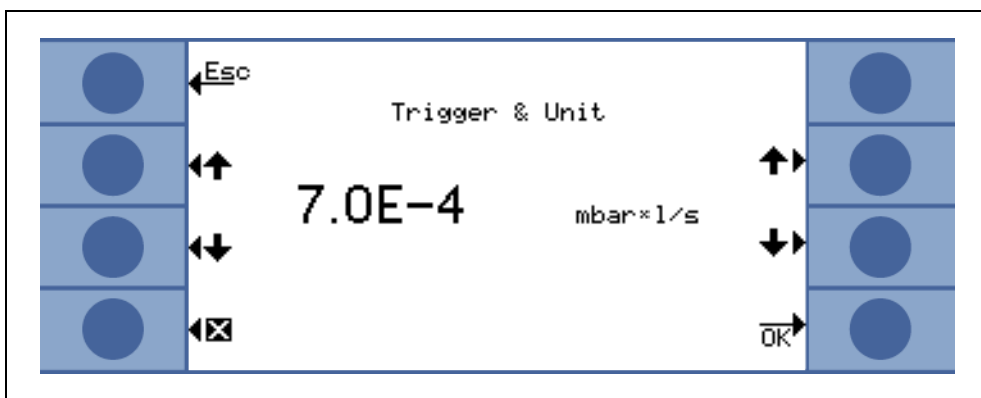

Fig. 4-7 Setting-up trigger level and unit of measurement

Pos.	Description	Pos.	Description
1	Increasing the trigger value	3	Changing the unit of measurement
2	Decreasing the trigger value	4	Changing the unit of measurement

Display limit

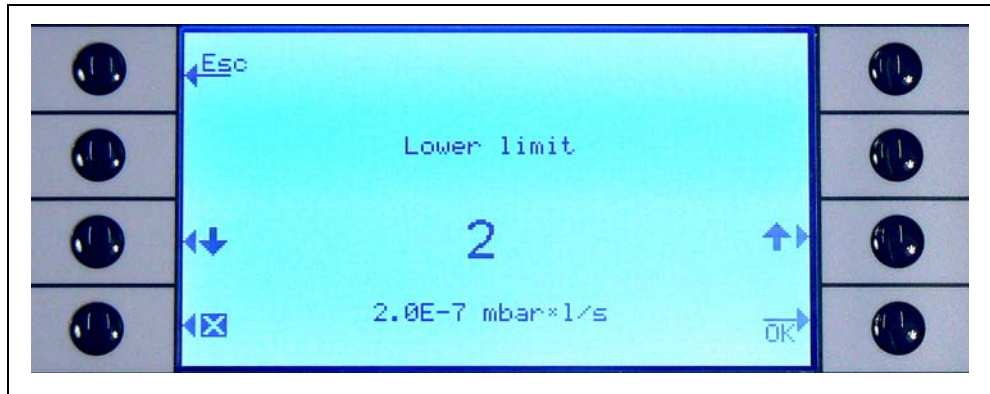

Fig. 4-8 Editing the lower display limit

The lower display limit for each gas can be edited. To change the lower display limit go to the “DISPLAY LIMIT” line item in the “EDIT GAS” submenu and press “EDIT”. The lower display limit can be increased in factors of the lowest display limit. In the line below the factor the absolute lower display limit in the currently chosen unit of measurement is stated. Available factors are 1, 2, 5, 10, 20, 50, 100.

For the Protec P3000XL the lowest display limit of 1×10^{-6} mbar l/s equals factor 1. The equivalent absolute lower display limits at other factors are the lower display limit in LOW FLOW mode multiplied by a factor of 10.

Notice For Protec P3000XL only:

When switching from LOW FLOW to HIGH FLOW (or vice versa) the lower display limit factor will remain unchanged, i.e. if the lower display limit factor is set to 2, the lower display limit will be adopted from 2×10^{-7} mbar l/s to 1×10^{-6} mbar l/s automatically when switching from LOW FLOW to HIGH FLOW.

Default value: 2

Search level

An additional warning level can be entered as percentage of the trigger level. A warning signal will be issued for leaks that are below the trigger level but above the search level in order not to miss small leaks. The search level may be set to values between 5 and 100%. Default value: 90%

4.3.2 Selecting a set of gas parameters

A set of gas parameters can be selected by setting the Mode in the Gas Edit menu to “enabled”. Enabling a set of parameters will automatically disable all other three sets of parameters so that only one set of parameters is used at the time.

4.4 Settings Sub-menu

In the settings sub-menu several settings which are important for the leak testing procedure can be edited.

4.4.1 Vacuum & Access

In the Vacuum Access sub-menu setting monitoring functions like the ZERO function, the flow limits and the contamination limit setting can be edited.

Zero time

The ZERO function is automatically updated when the background decreases so that negative values will never be displayed, thus avoiding unintended missing of leaks. The ZERO TIME is the time the leak rate has to be negative in order for the Protec P3000 to update the background level. The ZERO TIME can be set to values between 1.0 and 9.9 s.

Default value: 5.0 s

Contamination Limit

The Protec P3000 offers a protection mode against high helium concentrations (contamination with helium).

This feature should be used to prevent the sensor from accelerated aging when seeing large helium concentrations very frequently. The CONTAMINATION LIMIT can be set to levels of LOW, NORMAL AND HIGH. The contamination limit function will track the accumulated amount of helium sniffed over the last couple of seconds. If this accumulated amount of helium exceeds the preset level (LOW, NORMAL, HIGH) the message „contaminated“ will be displayed until the amount of helium in the system has decreased again sufficiently. However, the lower the CONTAMINATION LIMIT setting the smaller the largest possibly detected leak will be.

Notice You should start with the CONTAMINATION LIMIT set to LOW. If you feel that you get the „contaminated“ message too often, you may increase the CONTAMINATION LIMIT by one level at a time (to get the best usage out of your Wise Technology Sensor).

Default: NORMAL

The lower the contamination limit is set, the longer the life time of the Wise Technology sensor of the Protec P3000.

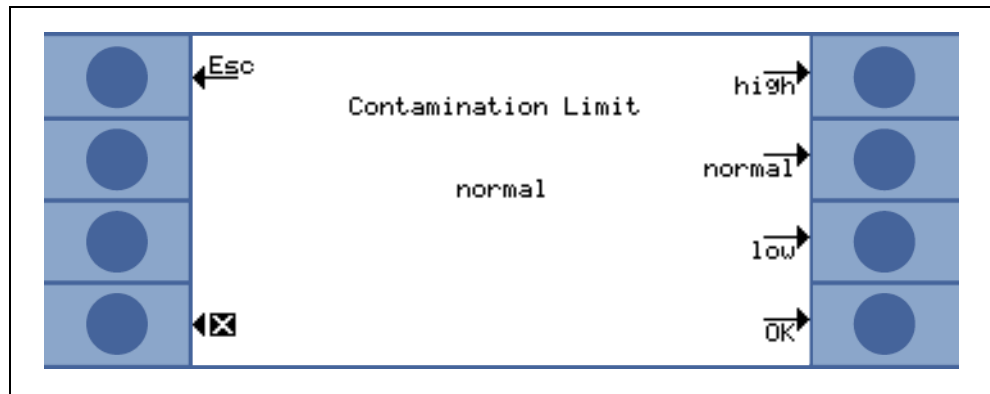

Fig. 4-9 Setting up the contamination limit

Notice The Protec P3000 should not be switched off or set to STANDBY mode while HELIUM CONTAMINATED as this will trap the increased levels of helium inside the sensor and it cannot be pumped away for clean up of the Protec P3000. Switching of the Protec P3000 while contaminated with large concentrations of helium will in fact lead to significantly increased start-up times afterwards. If this has happened by mistake, just switch on the Protec P3000 and let it sit in "Warm up" until it reaches measurement mode.

Flow limits
(for Protec P3000 only)

In this submenu the minimum and maximum gas flow through the capillary is entered. If the actual gas flow drops below this limit (e.g. if the capillary becomes partially blocked) or exceeds this limit (e.g. if the sniffer line is damaged so that ambient air is sucked in) an alarm is issued. The closer the LOWER FLOW LIMIT is set to the actual gas flow the more sensitive the Protec P3000 will respond to beginning clogging of the filters and the sniffer line itself. The closer the UPPER FLOW LIMIT is set to the actual gas flow the more sensitive the Protec P3000 will respond to damages to the sniffer line.

Notice The flow through the sniffer line depends on the atmospheric pressure. If operated at high altitude the flow through the sniffer line may drop significantly (approx. 20% per 1000 m altitude). In this case, please adjust the flow limits accordingly.

The LOWER FLOW LIMIT can be set to values between 150 and 240 sccm. Default value is 180. The UPPER FLOW LIMIT can be varied between 300 and 650 with a factory default value of 350.

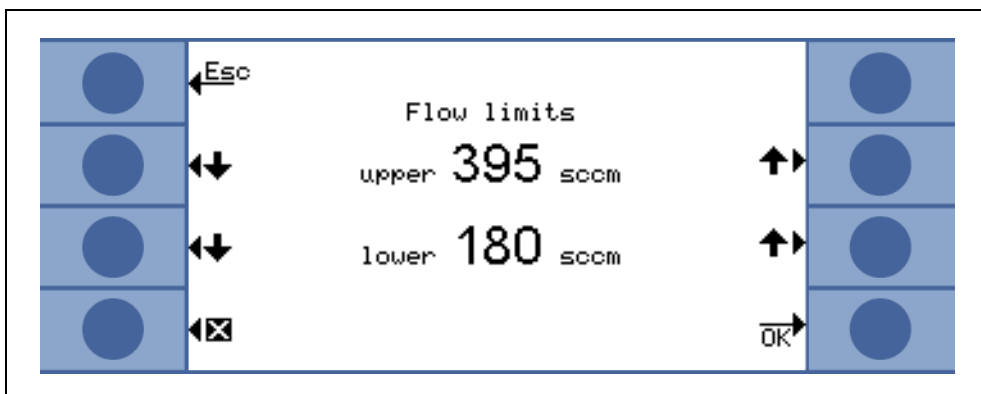

Fig. 4-10 Changing the flow limits of the SL3000 sniffer line

Flow settings
(For Protec P3000XL only)

The Protec P3000XL can be used in LOW FLOW mode as well as in HIGH FLOW mode. In the flow settings submenu all settings related to both flow modes can be adjusted.

When entering the FLOW SETTINGS submenu four further submenus will be displayed:

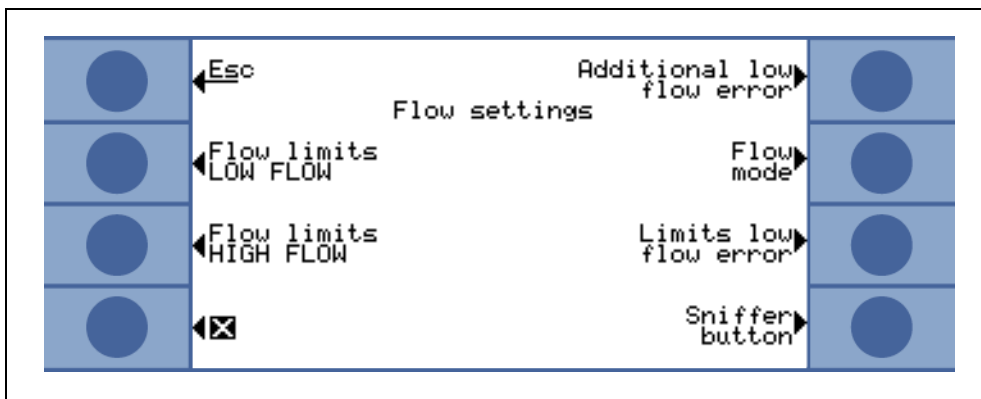

Fig. 4-11 Setting up flow settings

Flow limits LOW FLOW

In this submenu the UPPER FLOW LIMIT and LOWER FLOW LIMIT for the LOW FLOW mode may be set-up. The LOWER FLOW LIMIT can be set to values between 150 and 240 sccm. Default value: 180

The UPPER FLOW LIMIT can be varied between 300 and 650 sccm. Default value: 395

Flow limits HIGH FLOW

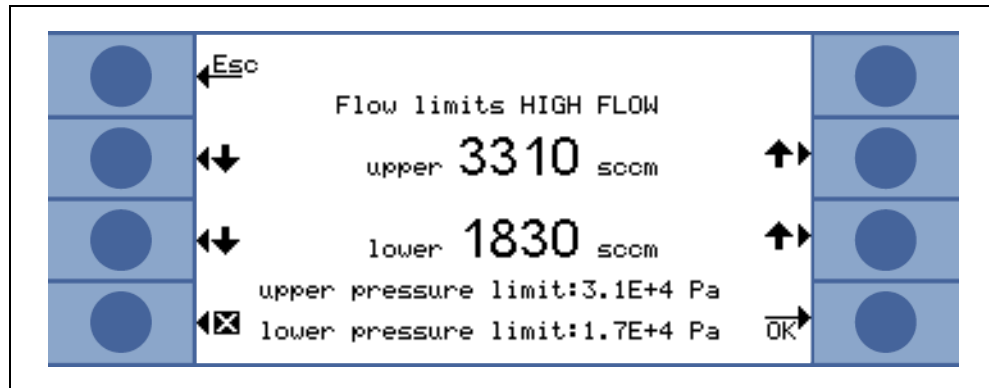

Fig. 4-12 Variation of flow limits

In this submenu the UPPER FLOW LIMIT and LOWER FLOW LIMIT for the HIGH FLOW mode may be set-up. The LOWER FLOW LIMIT can be set to values between 1500 and 2400 sccm. Default value: 1800

The UPPER FLOW LIMIT can be varied between 3000 and 3990 sccm. Default value: 3950

Notice To be able to measure in HIGH FLOW and LOW FLOW mode, the SL3000XL is equipped with two capillaries (~300sccm and ~2700 sccm). In LOW FLOW mode only the smaller capillary is used, in HIGH FLOW mode both are used, but only the gas from the smaller one is directed to the Wise Technology sensor.

To monitor the correct flow through the smaller capillary in HIGH FLOW mode (if blocked, no leaks are detected any more), the flow limits in HIGH FLOW mode are converted into corresponding PRESSURE LIMITS at the Wise Technology sensor. If these PRESSURE LIMITS are exceeded or undercut, this is an indication of the smaller capillary's flow being out of the normal range and a warning message (W41 or W42) is issued.

Additional low flow error (only available in ADVANCED mode)

Notice This submenu is only available when in ADVANCED mode and if a SL3000XL sniffer line is connected to a Protec P3000XL main unit.

In this submenu an ADDITIONAL LOW FLOW ERROR may be ENABLED or DISABLED. If ENABLED an additional flow error (E55 / E56) will be issued in addition to the standard low flow warnings. Only if the ADDITIONAL LOW FLOW ERROR is ENABLED, the button LIMITS LOW FLOW ERROR will be available.

If a LOW FLOW ERROR occurs, the Protec P3000XL will stop measuring. Only when the cause of the low flow problem has been resolved and the flow is above the LIMITS LOW FLOW ERROR again, the Protec P3000XL will go back into measurement mode.

The LIMITS for the LOW FLOW ERROR may be set -up in the LIMITS LOW FLOW ERROR submenu (see below).

Default setting: disabled

Flow mode (only available when SL3000XL sniffer line is connected)

In this submenu the Protec P3000XL can be switched between LOW FLOW mode and HIGH FLOW mode.

Default setting: HIGH FLOW Mode

Limits low flow error

This submenu is only available if the ADDITIONAL LOW FLOW ERROR is set to ENABLED.

In this submenu the limits for the ADDITIONAL LOW FLOW ERROR may be set-up. If the actual flow through the sniffer line drops below the LIMITS LOW FLOW ERROR, the Protec P3000XL will stop measuring. Only when the cause of the low flow problem has been resolved and the flow is above the LIMITS LOW FLOW ERROR again, the Protec P3000XL will go back into measurement mode.

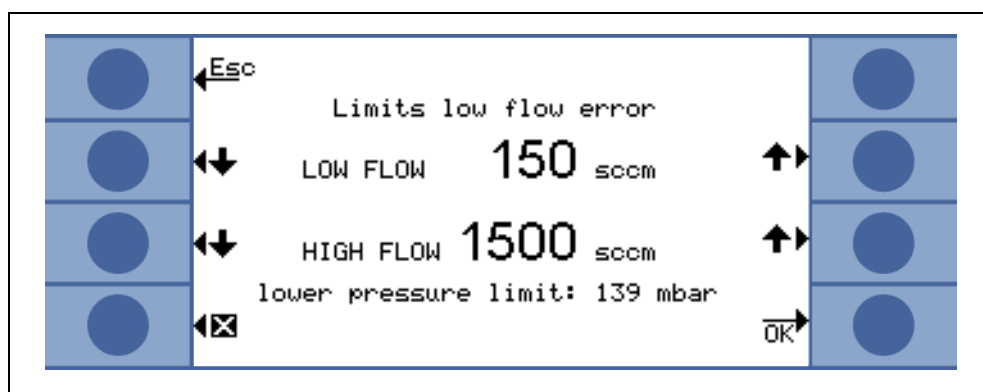

Fig. 4-13 Additional limits for low flow error

Two different values for the HIGH FLOW and LOW FLOW mode may be entered. The value for the HIGH FLOW mode will also be converted into a corresponding LOWER PRESSURE LIMIT. If the corresponding LOWER PRESSURE LIMIT is undercut, this is an indication of the smaller capillary's flow being blocked in SL3000XL sniffer line and also E55 / E56 will be issued and the Protec P3000XL will stop measuring.

Error limits can be set to values between 150 and 240 sccm for LOW FLOW mode and to values between 1500 and 2400 sccm for HIGH FLOW mode.

Default value: 150 sccm for LOW FLOW mode
 1500 sccm for HIGH FLOW mode

Sniffer button

In this submenu the use of the right sniffer button for switching between LOW FLOW and HIGH FLOW mode during leak testing (except when in I-Guide mode) may be ENABLED or DISABLED. If the use of the SNIFFER BUTTON is DISABLED, the Protec P3000XL may only be switched from HIGH FLOW to LOW FLOW mode (or vice versa) through the FLOW MODE submenu or via RS232.

Default setting: enabled

Standby Delay

The Protec P3000 offers a STANDBY mode to preserve filters and sensor life time in times when the Protec P3000 is not used. During the STANDBY mode the flow through the sniffer line will be stopped, thus no dirt is pumped through the filters and the sensor is not subjected to the helium background presented in the testing environment.

The time until the Protec P3000 goes into STANDBY mode is determined by the STANDBY DELAY time. The STANDBY delay time can be set to values between 10 s and 1 h. If the probe is not moved for the set STANDBY delay time the Protec P3000 will switch to STANDBY mode automatically. If the probe is moved during this time, the counter will be set back to zero and start again.

If the probe is picked up when the Protec P3000 is already in STANDBY mode the Protec P3000 will go back into operation automatically and will be ready for measurement again in approx. 5 sec.

Default value: 10 min.

Notice It is recommended to keep the STANDBY delay time as short as possible to minimize wear of the systems without causing too much interruption of your operations.

Cal

In the CALibration submenu an internal calibration can be ENABLED or DISABLED. If the function is set to DISABLED, only a proof function with the built-in PRO-Check reference leak will be possible.

Default value: ENABLED

Change menu PIN

Any changes to the current settings may be password protected. The menu PIN can be changed in the "change menu PIN" submenu.



Fig. 4-14 Setting-up a Menu-PIN for parameter protection

If a new PIN is entered the Protec P3000 software will ask to repeat the new PIN to prevent entering errors. Afterwards the menu PIN will be changed to the new value.

Notice The operator needs to go back up through the main menu for this change to become effective immediately. Otherwise, the new PIN will be activated after 5 minutes.

A menu PIN of “0000” means no password protection, all menus can be freely accessed.

Default setting: 0000

4.4.2 Audio Functions

In the Audio sub-menu all settings regarding the different audio alarms of the Protec P3000 can be edited.

Beep sound

Beep sounds are sounds that are issued as confirmation of certain functions, e.g. completion of a calibration process. This acknowledgement sounds can be enabled or disabled in the beep sound submenu.

Default value: enabled.

Audio intern

The internal loudspeaker of the main unit can be switched on and off. This will not effect the headphones outlet.

Default value: enabled.

Audio sniffer

The loudspeaker of the probe handle can be set to issue an alarm when the TRIGGER level is exceeded, when the SEARCH level is exceeded or can be disabled completely.

Default value: TRIGGER.

Alarm type

Different types of audio alarm of the main unit speaker can be selected. Options are SETPOINT, PINPOINT, and TRIGGER ALARM.

SETPOINT The frequency of the tone will change when the trigger level is exceeded. Below the trigger level the loudspeaker will remain off.

TRIGGER ALARM An acoustic alarm with a continuous low tone will sound as soon as the search level is exceeded. An acoustic alarm which consists of two tones sounds as soon as the trigger level is exceeded. Below the search level the loudspeaker will remain off.

If the Protec P3000 is set to TRIGGER ALARM as the alarm type an additional button will be shown on the lower right side called TONE 1,2,3. With this button different alarm sounds can be selected for the trigger alarm to clearly distinguish between nearby other leak detectors.

PINPOINT The external loudspeaker is always on. Within the leak rate range of +/- one decade of the trigger level the frequency will change depending on the leak rate. Outside this range the tone will be constantly low or high. This setting is recommended if also leaks which are still below the trigger level need to be pinpointed or if the expected leak rates are within the range of the trigger level.

Default value: Trigger Alarm

Volume

The MINIMUM VOLUME and the currently selected VOLUME for the loudspeaker in the main unit can be edited. The MINIMUM VOLUME is the lowest level the volume can be set to from the main display and should prevent unintentional turning off of the main unit audio alarms. Both values will also be valid for the headphones outlet. Both volumes (minimum and current) can be chosen between 0 and 15.

Default value for minimum volume: 2

Default value for the current volume: 2.

4.4.3 Display Settings

In the DISPLAY SETTINGS submenu the contrast of the display can be changed and the peak hold function can be set-up.

Contrast

In the CONTRAST submenu the contrast of the main unit display can be adjusted. Values between 0 and 99 can be entered. Also the display can be switched to inverted colours.

Default value: not inverted, Level 30

Notice If by accident the display contrast has been set too high or too low so that it cannot be read off anymore, this can be fixed as follows: Shut off the Protec P3000 and switch it back on. During run-up press the third button from the top on both sides of the display simultaneously until the contrast is back to normal. This setting is not saved to the EEPROM but needs to be confirmed manually through the contrast menu. Otherwise the Protec P3000 will go back to the out of range setting after the next start-up.

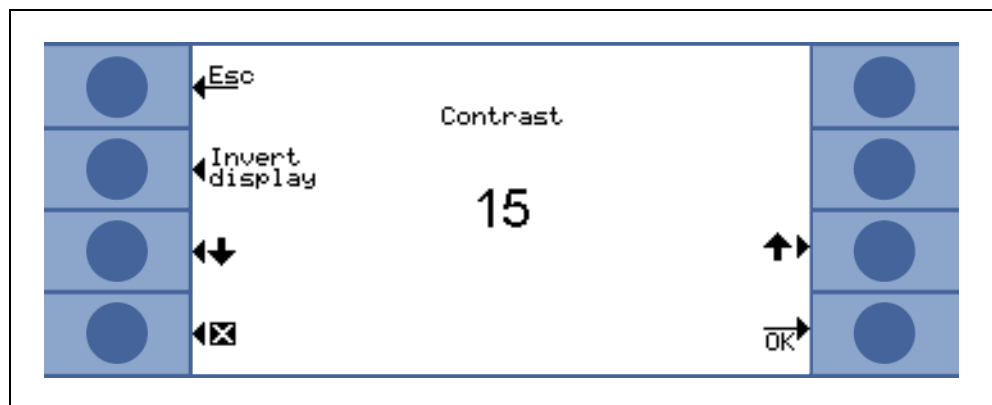

Fig. 4-15 Setting-up the contrast of the main display

Peak hold

The PEAK HOLD function can be enabled or disabled in this submenu. If the PEAK HOLD function is enable the maximum leak rate will be displayed for a preset time in addition to the currently measured value in the main display. The time setting will have no effect if this function is disabled.

Default: value disabled, 5 s.

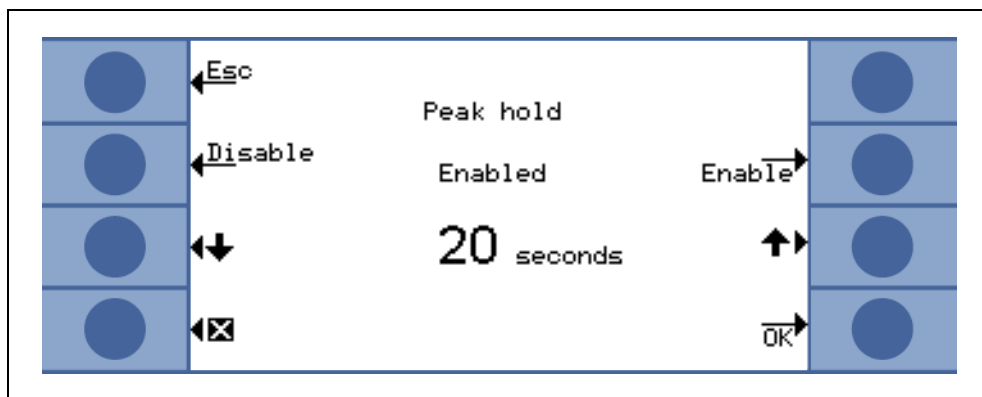

Fig. 4-16 Setting-up the peak hold function

Flow display (only available
in ADVANCED mode)

In the FLOW DISPLAY submenu the continuous display of the flow through the sniffer line during measurements can be ENABLED or DISABLED. If ENABLED, the flow will be indicated in the STANDARD OPERATION MODE only underneath the leak rate bar graph as integer number.

Notice After certain events like acknowledging warnings or when switching the flow mode, the flow monitoring may be disabled for a short period of time while the flow stabilizes to a final value again and no new warnings will be issued. During this time a message "Flow control inactive" will be displayed instead of the flow value.

Default setting: disabled

User mode

In this submenu either the NORMAL or the ADVANCED mode can be selected. In the NORMAL mode only the most relevant information for normal operation will be displayed whereas in the ADVANCED mode additional information for advanced users will become available.

4.4.4 Setting-up / editing an I•Guide Program

When selecting the SETUP PROGRAM button a submenu page will open showing the list of 10 pre-programmable I•Guide programs and their current status (enabled / disabled). If a program is enabled it will be offered in the list of programs to select from when operating in the I•Guide mode. To change the status of a program use the ON / OFF button on the left side of the display.

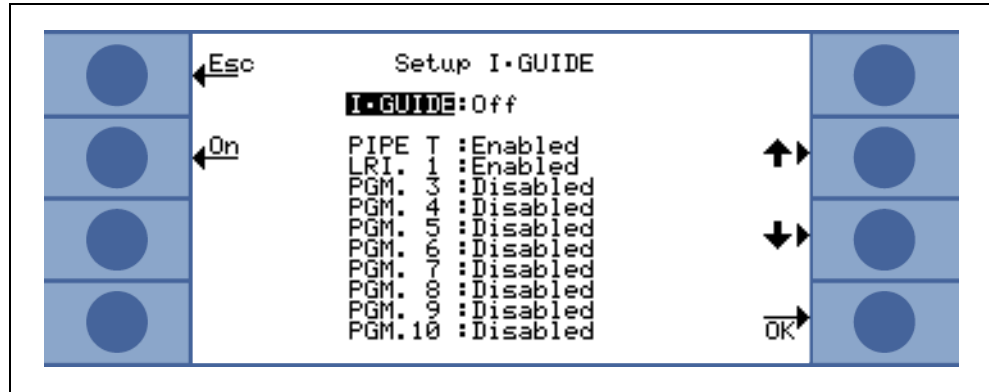

Fig. 4-17 Setting-up the I•Guide Mode

To edit the parameters of a program select the program by scrolling to the corresponding menu line and open the selected program by pressing the “EDIT” button.

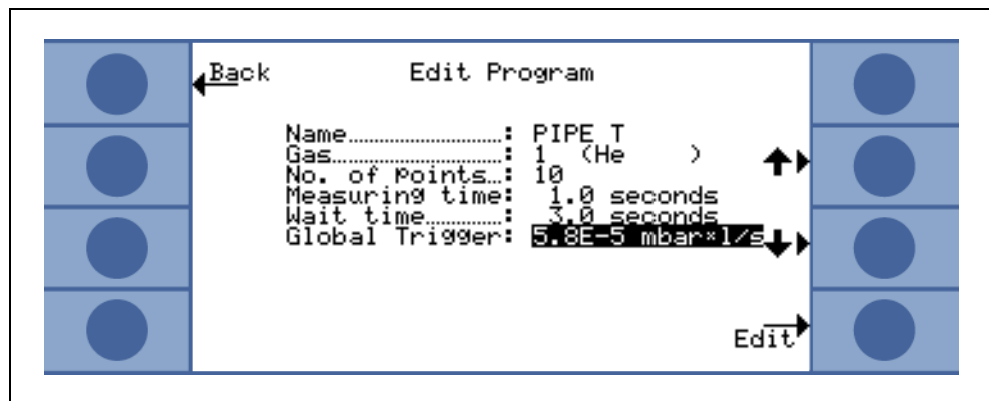

Fig. 4-18 Editing an I•Guide program

In the opening EDIT PROGRAM sub-menu the name of the program, the gas type selected for this program, the number of locations to be leak tested, the minimum measuring time for each location as well as the wait time between two leak tests allowed for moving the sniffer to the next location is stated. In addition, the summarized global trigger value corresponding to the allowable leak rate for the complete unit under test is stored.

Each parameter can be edited by scrolling to the appropriate line item and selecting the highlighted item by pressing the EDIT button.

Name

Each program can be named with a free text, descriptive name up to 6 characters. The name can be edited by highlighting the name line and pressing EDIT. An alphanumerical entry screen will open. Press ok after entering the desired name description.

Gas type

For editing the gas equivalent go to the "GAS" line item and press "EDIT". Only gas equivalents that are listed in the "GAS/TRIGGER" submenu (Gas1 to Gas4) are available for selection. The gas equivalent is stated in plain text in parenthesis. The list of maximum four available gas equivalent can be scrolled with the up and down buttons.

Notice The I•Guide Mode refers to the gas equivalent selected in the "GAS/TRIGGER" submenu. If you change a gas equivalent in the "GAS" submenu the gas equivalent selected for the I•Guide program will automatically change as well.

No. of points

The number of potential leak locations to be checked can be varied between 0 and 99 and can be edited with the up and down keys.

Default value: 4

Notice The I•Guide mode can also be used as a timer signal only. If the number of points is set to 0, the Protec P3000 will prompt for the next location to be tested continuously without using the global leak rate function.

Notice The I•Guide mode can also be used to summarize leak rates on demand. If the number of points is set to 99, a results screen with summarized global leak rate will be displayed after the right button has been pressed for 2 s continuously (or after the 98th point automatically).

Measuring time

The MEASURING TIME during which the sniffer tip needs to be hold to the correct location can be programmed to values between 0.7 and 25.0 s. The measuring time should not be less than the response time of the Protec P3000. We recommend to use the following minimum measuring times:

Sniffer line length	min. measuring time
3m	0.7 s
5m	0.9 s
10m	1.4 s
15m	3.0 s

Please use the UP and DOWN buttons for editing this parameter.

Default value: 1.0 s

Wait time

The WAIT TIME between two leak checks allowed to move the sniffer to the next potentially leaking location can be varied between 0.1 s and 25.0s in steps of 0.1s . Please use the UP and DOWN buttons for editing this parameter.

Default value: 3.0 s

Global trigger

In the GLOBAL TRIGGER submenu the maximum allowable leak rate for the complete unit under test can be edited. The same ranges as for a single trigger value are allowed. The unit of measurement for the global trigger will be the same as selected for this gas type in the edit gas submenue.

Default value: 2×10^{-3} mbar l/s (or the equivalent in any other unit of measurement)

4.4.5 Miscellaneous Settings

Language

Different languages can be chosen in which the software can be operated. The current selection includes English, German, Spanisch, Italian, French, Portugese, Japanese (Katakana) and Chinese (Mandarine).

Default value: English

Notice If the Protec P3000 has been set to a language that you do not understand, turn off the power and press the second button from the top of the display on both sides simultaneously during run-up. This will reset the Protec P3000 to English as the menu language. This setting is not saved automatically. Please go to the LANGUAGE submenu afterwards and select the appropriate language.

Date & Time

In this submenu the internal clock of the Protec P3000 can be set. On the first page the date needs to be entered in the format DD.MM.YYYY. The lower right button (→) opens the second page on which the time in the format HH.MM is entered.

Sniffer light

The intensity of the sniffer light can be varied to the desired level. The intensity can be selected between 1 and 6. Also the light can be switched on and off via the DISABLE / ENABLE buttons. Any new setting must be confirmed with the OK button.

Default value: on, level 4.

Pressure unit

The pressure unit of all displayed values of the Protec P3000 can be set to Pa, Torr, atm or mbar.

Default value: mbar

Leak rate filter

For all normal operation the I•Filter should be selected. I•Filter is an intelligent filtering algorithm that yields the best results with respect to noise level and stability of leak rate values specifically developed for use in the Protec P3000 leak detector.

Only in cases where the older Protec model is replaced by an Protec P3000 and the leak detector is used in a fixed testing system it may be required to stick with the "FIXED" filter that was used in the Protec.

Default: I•Filter

Alarm delay

Under conditions with very unstable background conditions it may be favourable to not issue an alarm immediately but only release an audio alarm if the trigger level has been exceeded for an extended time. This alarm delay can be entered in 1/10 of a second. Values between 0 and 9.9 sec will be accepted. Default value: 0.0 sec (i.e. disabled).

4.5 Interfaces

In the INTERFACES submenu the CONTROL LOCATION, the RECORDER OUTPUTS, the PLC inputs, the RS232 PROTOCOL and the BAUD RATE & END SIGN can be edited.

4.5.1 Control location

The CONTROL LOCATION can be "LOCAL", "RS232" or "LOCAL AND RS232". In LOCAL mode the RS232 interface can only be used to read data, but not for control purposes. In RS232 mode, the Zero and Cal functions are controlled solely via the interface. In LOCAL AND RS232 mode the Protec P3000 can be controlled via the interface but also by input from the main display.

Default setting: local and RS232

Notice Even with the control location set to RS232 some parameter may still be able to be changed through the main units software menus. Please lock these by activating the menu PIN to prevent unintended changes.

4.5.2 Recorder outputs

The RECORDER OUTPUT SCALE is linear and logarithmic. The linear output signal is provided through channel 1 (pin 1 of the I/O port) and the logarithmic output is provided through channel 2 (Pin 14 of the I/O port) (see Section 6.1).

In logarithmic output scale the voltage range is 0 - 10 V. Beginning at 1V, each leak rate decade is spread over 2 volts, i.e.:

- 1...3V: 1st decade
- 3...5V: 2nd decade
- 5...7V: 3rd decade
- 7...9V: 4th decade

Thus a leak rate range of 4 decades will be output by way of an analog signal. The four decades are set through the value and the unit of measurement for the trigger level. The software of the Protec P3000 will set the output voltage in such a manner that the trigger level itself will always be set within the second decade (i.e. within the range of 3 to 5 Volts).

Examples:

Trigger level	Output voltage (1 to 9V) will correspond to
3 g/a	0.1 to 1000 g/a
0.2 oz/yr	0.01 to 100 oz/yr
5×10^{-4} mbar l/s	1×10^{-5} to 1×10^{-1} mbar l/s

The following table has been provided to clarify the way in which the output voltage represents the leak rate.

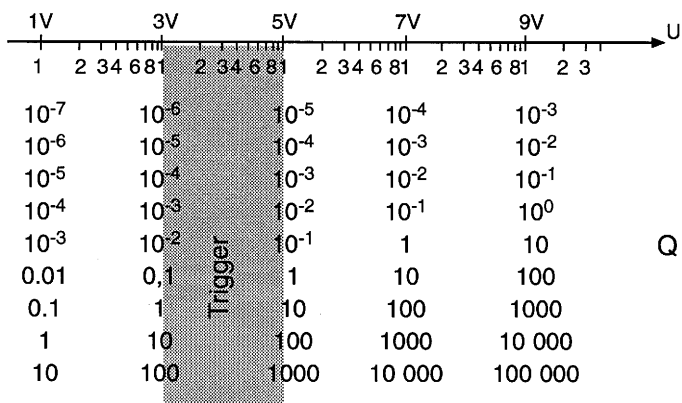

Converting an output voltage to a leak rate

If the recorder outputs a certain voltage and you want to convert this to a leak rate, the following formula applies:

$$\text{leak} \cdot \text{rate} = 10^{\text{Trigger} \cdot \text{exponent} + \frac{U-3}{2}}$$

(2 is used since one decade is spread over 2 Volts. 3 is used because the trigger level will always be within the range of 3 to 5 V).

Example calculations:

Trigger	Trigger exponent	Output voltage	Leak rate
0.1 oz/yr	-1	5.35V	$10^{-1 + \frac{5.35-3}{2}} = 1.5 \text{ oz/yr}$
3 g/a	0	5.60V	$10^{-0 + \frac{5.6-3}{2}} = 20 \text{ g/a}$
		6.4V	$10^{-0 + \frac{6.4-3}{2}} = 50 \text{ g/a}$
5 x 10 ⁻⁴ mbar l/s	-4	2.8V	$10^{-4 + \frac{2.8-3}{2}} = 8 \cdot 10^{-5} \text{ mbar l} \cdot \text{s}$
		6.556V	$10^{-4 + \frac{6.55-3}{2}} = 1.5 \text{ mbar l} \cdot \text{s}$

Converting a trigger leak rate to a trigger output voltage

If you want to know the corresponding voltage for a specific trigger leak rate, the following formula applies:

$$U = 3 + 2 \cdot \log(\text{mantissa of scientific notation of trigger value})$$

(The factor of 2 is used since one decade is spread over 2 Volts. The summand of 3 is used because the trigger level will always be within the range of 3 to 5 V).

Example

Trigger leak rate	Scientific notation	Mantissa	Trigger voltage
$2 \cdot 10^{-5}$ mbar/l/s	$2 \cdot 10^{-5}$	2	$3 + 2 \cdot \log(2) = 3.6$ V
5 g/a	$5 \cdot 10^0$	5	$3 + 2 \cdot \log(5) = 4.4$ V
0.4 oz/yr	$4 \cdot 10^{-1}$	4	$3 + 2 \cdot \log(-1) = 4.2$ V

Recorder Output

In linear output scale different settings can be chosen in the submenu RECORDER OUTPUT. The voltage range spans from 0 V to 10 V.

The recorder output can be set so that the max. 10 V corresponds to either 1×10^{-4} mbar l/s, 1×10^{-3} mbar l/s, 1×10^{-2} mbar l/s, 1×10^{-4} Torr l/s, 1×10^{-3} Torr l/s, 1×10^{-2} Torr l/s. Alternatively, the recorder output can be set so that 10 V corresponds to 10 x trigger level, i. e. 1 V equals the selected trigger level.

In the modes "ERROR", "NOT READY TO MEASURE" and "STANDBY" a voltage of $U = 10$ V will be output through channels 1 and 2.

Default setting: AUTO

4.5.3 RS232 Protocol

The RS232 protocol can be set to "ASCII", "DIAGNOSTICS", "PRINTER AUTO" or "PRINTER MANUAL". The ASCII protocol is a protocol similar to the SCPI, a standard protocol widely used for measuring equipment. For details on this protocol please refer to the Interface Description (kins26e1).

Default setting: ASCII

Diagnostics

The DIAGNOSTICS protocol is a binary protocol used by INFICON for analysis in quality control and trouble shooting during manufacturing and service.

Printer manual

The PRINTER MANUAL protocol allows to send leak rates on pressing the right sniffer probe button.

Notice When in any of the two printer modes, no ASCII commands must be sent to the Protec P3000 as this will interrupt the printer mode.

<i>Format</i>				
Date	Time	Gas equivalent	Leak rate	Unit
<i>Example</i>				
03.05.2005	12:31	He	6x10 ⁻⁴	mbar l/s

When set to I-Guide mode the PRINTER MANUAL mode is without function.

Printer auto

In PRINTER AUTO the leak rate will be sent any time the set trigger level is exceeded. At the time the signal drops below the trigger level the maximum detected leak rate will be sent.

<i>Format</i>				
Date	Time	Gas equivalent	Leak rate	Unit
<i>Example</i>				
03.05.2005	12:31	R134a	2.34	g/a

When set to I-Guide mode the leak rate results will be sent after each test point together with the test point number. After the test cycle has been completed, the summarized global leak rate will be sent.

Example:

Point no.	Date	Time	Leak rate	Unit
Point 01			8.3 E-6	mbar l/s
Point 02			2.0 E-6	mbar l/s
Point 03			8.4 E-6	mbar l/s
Point 04			1.2 E-6	mbar l/s
Global	13.04.2007	11:57:03	1.8 E-6	mbar l/s

4.5.4 Select PLC inputs

In the SELECT PLC INPUTS submenu the user can select which pin on the I/O port (suitable for PLC input) represents which command. The default setting is as follows:

Pin	Default Command	Pin	Default Command
7	Standby	13	Cal
8	Clear Error	20	Zero
9	Cal Abort	25	Not used

To change these settings select the appropriate pin with the UP and DOWN arrows on the left side of the display and afterwards select the desired command from the list of commands with the UP and DOWN buttons on the right side of the display. Press OK to save your settings.

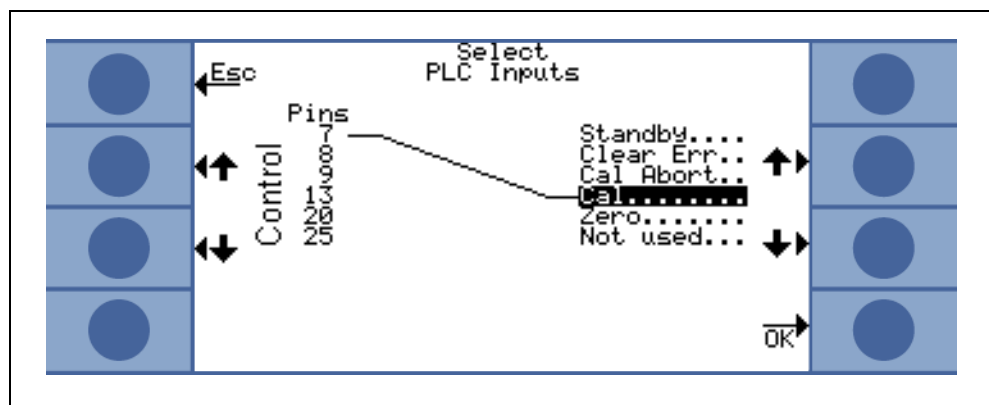

Fig. 4-19 Customizing PLC inputs

4.5.5 Baud rate & end sign

The baud rate can be set to values between 1200 and 19200. Default setting: 9600.
 The end sign can be set to Carriage Return (CR), Line Feed (LF) or to CR+LF.
 Default setting: CR+LF.

4.5.6 PRO-Check (only available in ADVANCED mode)

In this submenu the PRO-Check reference leak can be disabled completely so that for Protec P3000 leak detectors without a PRO-Check onboard the leak detector does not check for the electrical connection with the reference leak anymore and no error message is issued.

Default value: Enable

4.6 The Info Menu

The INFO MENU lists all internal data that may be useful for any trouble-shooting of the Protec P3000. The INFO MENU consists of 10 pages. On each page the upper left button "BACK" allows to leave the info menu, the lower left button allows to go back one page whereas the lower right button allows to go to the next page. The page number is displayed in the upper right corner.

Menu item	Format	Description
Page 1: General Data		
Foreline pressure	mbar	
Flow	sccm	Flow through sniffer line
Time since power on	Min	
Operation hours	h	
Serial number	11-digit number	
Wise Serial number		
Software version	x.xx.xx	
Circuit temperature	°C	Temperature of main board
Test leak temperature	°C	
Sensor block	Protec P3000 1 / 2 / 3	1 = Protec P3000 2 = Protec P3000 with extended measurement range 3 = Protec P3000XL
Page 2: Sensor Global		
I akt.	A	
B-Filter	A	
I-Filter	A	
Q-Filter	A	
Leak rate	mbar l/s	helium leak rate
PWM-Membrane	Integer	
Heater Voltage	V	
High Voltage	V	
Wise-State	Integer	

Menu item	Format	Description
Measure Background	Press button	If pressing the MEASURE BACKGROUND button the Protec P3000 will go into a special measurement mode and determine the background concentration of Helium currently prevalent in the environment. This process may take a couple of seconds. This feature is not a continuous signal display but should be used for trouble-shooting purposes only.
Page 3: Sensor Errors		
Sensor Error	Hex Code	
Sensor / Valve Warning	Hex Code	
Adjust Error	Hex Code	
Page 4: PRO-Check data		
Gas	Helium	Gas type of internal leak
Leak rate nom. / at T	mbar l/s / mbar l/s	
Version / Checksum	Hex Code	
Serial no.		
Serial no reservoir		
Manufacturing date	DD.MM.YYYY	
Expiry Date	DD.MM.YYYY	
Gain / Offset		
Test leak temperature	°C / °F	
State		
Page 5: Sniffer data		
Type	SL3000 / SL3000XL / system	
Software version	x.x	
Length	3m / 5m / 10m / 15m	
Serial no.	9000 xxx xxxx	
Switch left	on / off	
Switch right	on / off	
Color	Green / red	
Bar graph		

Menu item	Format	Description
Acceleration x / y	x / x	
Flow at calibration	sccm / sccm	2 values for Protec P3000XK
Pressure at calibration	mbar / mbar	2 values for Protec P3000XL

Page 6: I/O Port data

Here the current PIN assignment is displayed. The default configuration is shown in the picture.

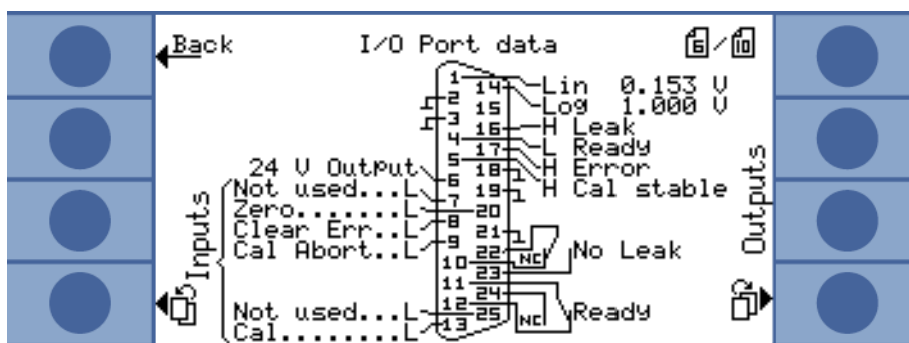

Page 7: Analog data

AIN3 Sniffer length	V	
AIN4 +5V II Leak	V	
AIN5 +24V III ext	V	
AIN6 +5V I Sniffer	V	
AIN8 -15V MC50	V	
AIN9 +15V MC50	V	
AIN10 +24V MC50	V	
AIN11 +24V I QMS	V	
AIN12 +24V II	V	

Page 8: Analog data

AIN0	V	
AIN0 offset	V	
Foreline pressure	mbar	
AIN1	V	

Menu item	Format	Description
Flow	sccm	
AIN2	V	
Page 9: Info valves		
V1: bypass	open / close	
V2: measure	open / closed	
V3: purge inlet	open / closed	
V4: purge sniffer	open / closed	
V5: sniffer	open / closed	
V6 / V7: HIGH FLOW	open / closed / not installed	for P3000XL only
Air pressure	mbar	
Normal mode	mbar	
Gross mode	mbar	
Zero pressure	mbar	
Page 10: RS232 Info		
Protec P3000 → sniffer	ASCII string	Command sent from main unit to sniffer
Sniffer → Protec P3000	ASCII string	Command sent from sniffer to main unit
Host → Protec P3000	ASCII string	Command sent from host to Protec P3000
Protec P3000 → Host	ASCII string	Command sent from Protec P3000 to host

4.7 History & Maintenance

In HISTORY & MAINTENANCE historical data that has been collected during the operation of the Protec P3000 can be viewed as well as information about the maintenance status of the leak detector.

View Error List

In the ERROR LIST all errors (and warnings) that have occurred during the operation of the Protec P3000 are summarized. In the list the DATE and TIME when the error occurred is stated followed by error or warning number (E xx being errors and W xx being warnings) with a short description of the error or warning. The full error message or warning may be displayed when scrolling to the appropriate line item and pressing the magnifying glass-button.

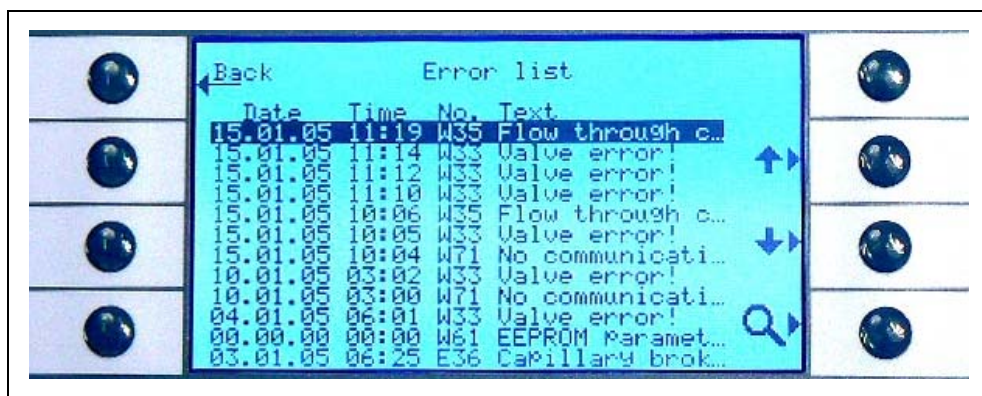

Fig. 4-20 Example of an Protec P3000 error list

Calibration history

In this listing all calibrations that were conducted during the operation of the Protec P3000 are collected. The DATE and TIME when they were performed are stated, followed by the type of calibration (internal / external) and the calibration factor.

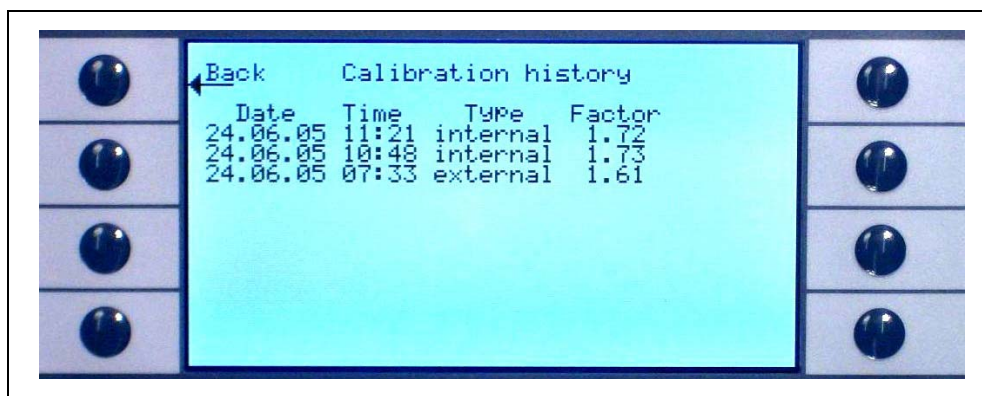

Fig. 4-21 Example of a Protec P3000 Calibration history

Sniffer tip filter

The maintenance interval for the sniffer tip filter depends on the operating environment and may be set to values between 10 and 999 hours. If set to ∞ the reminder message for the sniffer tip filter will be disabled.

Default value: 100 hours

For details on how to perform the maintenance tasks see Chapter 7, Maintenance.

When confirming that the filter has been replaced (without changing the interval time) press okay only and the counter will restart.



Fig. 4-22 Setting the maintenance interval for the sniffer tip filter and confirming its replacement

Maintenance interval

In the maintenance interval sub-menu the number of operating hours for the main unit in total, as well as the time until the next maintenance is due for the diaphragm pump, the main unit air filter and the optimization for the Wise Technology sensor.

When the number of operating hours have expired a warning will be issued as a reminder to perform the appropriate task. The reminders are issued for the diaphragm pump and the air filter of the main unit. Please also refer to Section 5.1 (Error Messages and Warnings)!

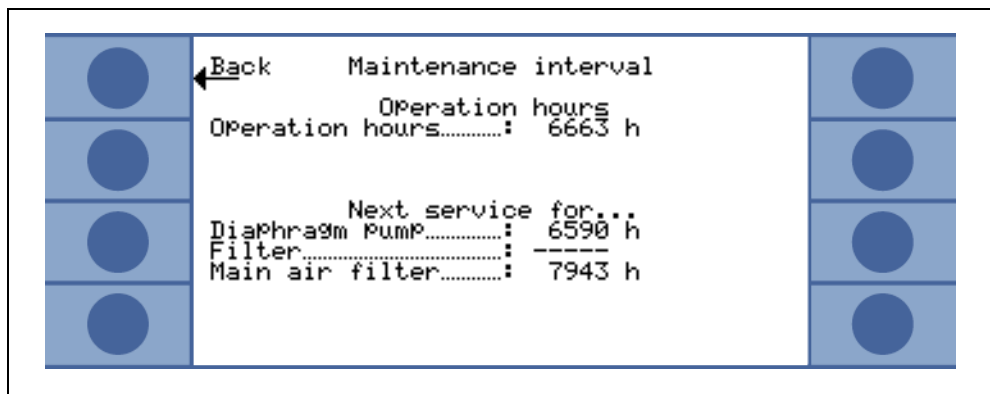

Fig. 4-23 Example of a maintenance interval menu page

Maintenance history

In the maintenance history list all maintenance tasks performed are listed. The date and the time the maintenance tasks were performed, the number of operation hours the Protec P3000 had worked at the time when the maintenance task was performed and the type of maintenance that was conducted are listed. Details about each maintenance task may be viewed when highlighting the appropriate line item and pressing the VIEW button.

Date	Time	Hours	Maintenance
28.04.10	14:13	5482	Wearing Par...
28.04.10	12:48	5480	Main air fi...
08.12.08	16:12	5184	Wise optimi...
08.12.08	10:50	5182	Wise optimi...
16.11.08	10:21	5151	Main air fi...
16.11.08	10:21	5151	THOMAPOR fi...
26.03.08	11:19	3433	Main air fi...
24.07.07	08:05	2498	Main air fi...
03.04.07	07:39	1977	Main air fi...
29.03.07	09:52	1967	THOMAPOR fi...
18.07.06	15:43	1319	Wearing Par...
21.04.06	14:50	1283	Wise optimi...

Fig. 4-24 Example of maintenance history list

Confirm maintenance (only in ADVANCED mode)

In this submenu the replacement of the main unit air filter can be confirmed and the date and the number of operation hours at which the maintenance task was performed is saved in the software.

Notice Maintenance of the diaphragm pump can only be confirmed in the (password protected) service menu by trained personell.

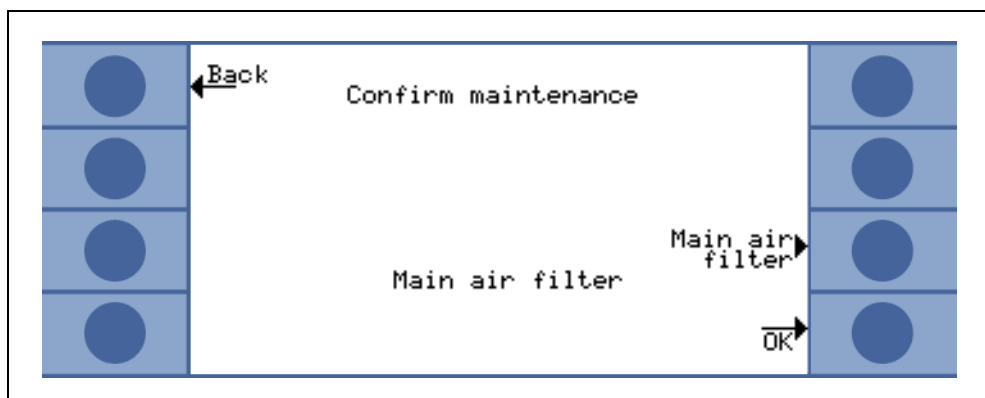

Fig. 4-25 Confirming maintenance task

For details on how to perform the maintenance tasks see Chapter 6, Maintenance.

Replace PRO-Check (only available if ENABLED and in ADVANCED mode)

When replacing the gas reservoir of the PRO-Check reference leak, the new serial number of the replacement gas reservoir as well as a code containing the calibration data of the new reservoir needs to be entered in this submenu. For details on how to replace the gas reservoir of the PRO-Check reference leak please refer to Section 7.7.

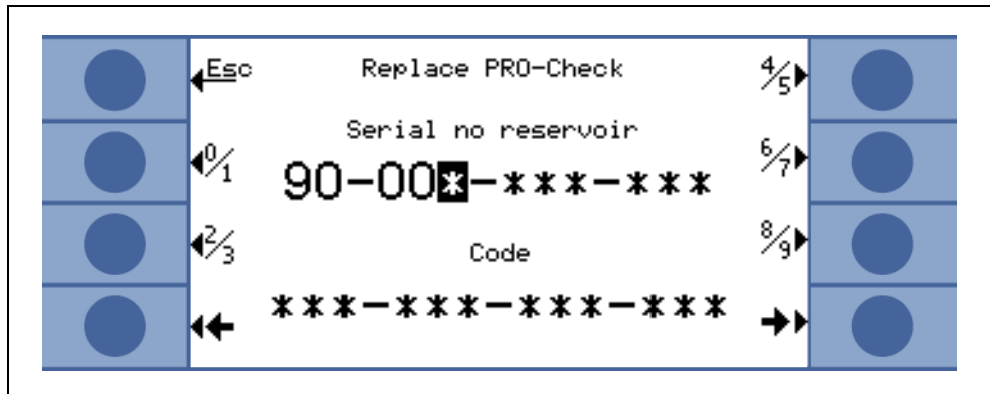

Fig. 4-26 Activating new PRO-Check gas reservoir

Notice PRO-Check Warrtime Expire Date (See Section 7.7.5).

5 *Protec P3000 Messages*

During leak detection operations the LCD display will indicate information which supports the operator in running the Protec P3000. Besides measurement data, also current equipment conditions, operating hints as well as warnings and error messages can be displayed.

5.1 *Error Messages and Warnings*

The Protec P3000 is equipped with comprehensive self-diagnostic functions. When a faulty condition is sensed by the control board, this condition is indicated to the operator via the LCD display as far as possible.

Errors

Errors are events which force an interruption of the measurements in progress and which the Protec P3000 is not capable of rectifying on its own. Errors are indicated in plain text together with an error number.

The Protec P3000 remains in the error status. After the fault cause has been removed the error can be acknowledged by pressing the RESTART button. The Protec P3000 then returns to the measurement mode.

Warnings

Warnings are issued if an abnormal condition is detected that may cause increased inaccuracies of measurements but will not interrupt measuring completely.

In the following table all possible error messages possible reasons for the problem and the recommendations on how to fix the problem are listed. If no recommendation is given (or the recommendation does not fix the problem), please call your nearest INFICON service representative (see Section 1.2.1).

Notice In case of enquiries please keep the serial number and the software version number of the Protec P3000 at hand.

The following abbreviation is used in the listing + error messages below:

MC50 CPU-board

Error no.	Plain text message	Possible Reason	Recommendation
E1	24V of the MC50 too low	Fuse F1 on the motherboard has blown	Replace fuse F1 on motherboard*
E2	24V of sensor heating too low	Fuse F2 on the motherboard has blown	Replace fuse F2 on motherboard*
E3	24V II too low	Fuse F3 on the motherboard blown	Replace fuse F3 on motherboard*
W4	24V of the OPTION socket too low	Fuse F4 on the motherboard has blown	Replace fuse F4 on motherboard*
W5	5V of the sniffer is too low	Fuse F5 on the motherboard has blown	Replace fuse F5 on motherboard*
W6	5V of the internal Leak too low	PRO-Check electronics defective	Replace PRO-Check reference leak or call nearest INFICON service representative!
E7	-15V of the MC50 is too low	Motherboard defective	Call nearest INFICON service representative!
E8	15V of the MC50 is too low	Motherboard defective	Call nearest INFICON service representative!
E9	High Voltage error	Problem in sensor electronics	Call nearest INFICON service representative!
W11	Wise current unstable	Current from Wise Technology sensor did not stabilize within 20 min. after start-up! Protec P3000 possibly not being used for several days, sensor current should stabilize with more run-time.	Restart the Protec P3000. If problem persists, call nearest INFICON service representative!
E12	Wise Sensor not ignited	Current from Wise Technology sensor too low for more than 10 min after power on	Restart the Protec P3000, if problem persists, call nearest INFICON service representative!
E13	Problem in Heater Control	Heater control for Wise Technology sensor defective.	Call nearest INFICON service representative!
W14	Discharge gone out	Sensitivity problem of Wise Technology sensor or No ambient helium present (e.g. sniffer purged with nitrogen) Warntime every 2h.	<div style="background-color: yellow; border: 1px solid black; padding: 5px; display: inline-block;">  Caution </div> Make proof or calibration. Restart with sniffer line connected to fresh air If problem persists, call nearest INFICON service representative!
W15	Replace sniffer tip filter	Filter in the sniffer tip is clogged	Replace the filter in the sniffer tip!
W17	Fore pump service interval expired!	> 10,000 operating hours since last fore pump service	Replace membrane of diaphragm pump!*
W18	Air filter service interval expired!	> 10,000 operating hours since last main air filter service	Clean or replace main air filter! See Section 7.2
E19	No communication with Wise ADC	Wise Technology sensor defective or CPU-board defective	Call nearest INFICON service representative!

Error no.	Plain text message	Possible Reason	Recommendation
E20	Temperature at electronic unit is too high (>60°)	Ambient temperature too high	Cool down environment, place Protec P3000 in cooler area.
		Ventilation failure	Check if fans on both side of main unit are running (check for air flow through inlets on both side of main unit housing)
		Air filter dirty	Clean or replace main air filter See Section 7.2
W24	24V for the ext. control unit too low	<u>For RC versions only:</u> Fuse on the RC-driver board blown	Replace fuse on RC-driver board!*
E25	Remove sniffer from CAL port	Sniffer inserted in calibration port during start-up or sniffer needs to be removed during internal calibration process	Remove sniffer from calibration port of PRO-Check!
		Light barrier of PRO-Check dirty	Blow out with fresh air and / or clean with cotton swab!
E26	Background too high or Wise sensor defective	Environment contaminated with helium or Wise Technology sensor defective!	Offer fresh air to sniffer line. If problem persists call nearest INFICON service representative
W28	Real time clock reset! Please enter date and time!	CPU-board has been replaced	Please enter date and time! See Section 4.4.5
		Battery on CPU-board faulty	Replace CPU-board*
E32	Wise Technology current too high	Wise Technology sensor current exceeds threshold value	Do not switch off Protec P3000(XL)!!! Supply fresh air through sniffer line quickly, restart the Protec P3000 and wait for Protec P3000 to recover! If problem persists, call nearest INFICON service representative!
W34	Flow has changed!	Flow has changed by more than 30% since last calibration (warning will disappear if change drops below 20% again).	Recalibrate the Protec P3000 (See Section 3.5) or replace sniffer line filters!
W35	Flow through sniffer too low	Actual flow is lower than lower flow limits (In LOW FLOW mode) Filter in sniffer line blocked Capillary blocked Filter in main unit blocked Lower flow limit setting too high	Replace sniffer tip filter See Section 7.4 Replace filters of sniffer line and recalibrate! (felt filter, capillary filter and / or filter pad in SL3000XL sniffer line and recalibrate) See Section 7.4 or Replace probe cable* Replace internal filter* Decrease lower flow limit See Section 4.4.1

Error no.	Plain text message	Possible Reason	Recommendation
E37	Flow through sniffer too high	<p>Actual flow is higher than upper flow limits (LOW FLOW and HIGH FLOW mode) or actual pressure is higher than upper pressure limit (HIGH FLOW mode only):</p> <p>Capillary broken or leaky</p> <p>Upper flow limit setting too low</p>	<p>Replace sniffer line and recalibrate or</p> <p>Replace probe cable*</p> <p>Increase upper flow limit</p> <p>See Section 4.4.1</p>
E38	Pump error	Fore pump defective	Call nearest INFICON service representative!
W39	Valve block error!	Cannot recognize valve block version during self-test	Call nearest INFICON service representative!
W40	Ratio of HIGH FLOW to LOW FLOW failed	<p><u>For Protec P3000XL only in HIGH FLOW mode:</u></p> <p>Flow in HIGH FLOW mode less than 5 times flow in LOW FLOW mode (during start-up or calibration only)</p> <p>Filter in sniffer line blocked</p> <p>Internal filter in main unit blocked</p> <p>Leak in LOW FLOW capillary</p> <p>Internal leak</p>	<p>Replace sniffer tip filter and recalibrate(See Section 7.4)</p> <p>Replace internal filter* and recalibrate</p> <p>Replace sniffer line and recalibrate</p> <p>If problem persists, call nearest INFICON service representative</p>
W41	HIGH FLOW too low	<p><u>For Protec P3000XL only in HIGH FLOW mode:</u></p> <p>Actual flow lower than lower flow limit (for high flow mode) or actual pressure at Wise Technology sensor below corresponding pressure limit</p> <p>Filter in sniffer line blocked</p> <p>Internal filter in main unit blocked</p> <p>Leak in LOW FLOW capillary</p> <p>Internal Leak</p>	<p>Replace sniffer tip filter (See Section 7.4)</p> <p>Replace internal filter*</p> <p>Replace sniffer line!</p> <p>Or: Replace probe cable!*</p> <p>See Section 7</p>

Error no.	Plain text message	Possible Reason	Recommendation
W42	Pressure at calibration differs between HIGH and LOW FLOW	<p><u>For Protec P3000XL only in HIGH FLOW mode:</u> Pressure at Wise Technology sensor differs from LOW FLOW mode to high flow mode (during start-up or calibration only)</p> <p>Filter in sniffer line blocked</p> <p>Internal filter in main unit blocked</p> <p>Capillary blocked</p>	<p>Replace sniffer tip filter and recalibrate (See Section 7.4)</p> <p>Replace internal filter* and recalibrate</p> <p>Replace sniffer line and recalibrate! Or: Replace probe cable!* and recalibrate</p> <p>See Section 7</p>
W53	Flow at calibration out of limits!	<p><u>Only for Protec P3000 or Protec P3000XL in LOW FLOW mode:</u> Flow at calibration higher than upper flow limit or lower than lower flow limit or limit low flow error (if enabled, whichever comes first)</p> <p>Filter in sniffer line blocked!</p> <p>Internal filter in main unit blocked</p> <p>Leak in (low flow) capillary</p> <p>Wrong flow limit or limit low flow error settings (for LOW FLOW mode)</p>	<p>Replace sniffer tip filter and recalibrate! (see section 7.4)</p> <p>Replace internal filter* and recalibrate!</p> <p>Replace sniffer line (or: replace probe cable*) and recalibrate!</p> <p>Check flow limit settings and limit low flow error (for LOW FLOW mode)! See section 4.4.1</p>
W54	Flow at calibration out of limits!	<p><u>Only for Protec P3000XL in HIGH FLOW mode:</u> Flow at calibration higher than upper flow limit or lower than lower flow limit or limit low flow error (if enabled, whichever comes first)</p> <p>Filter in sniffer line blocked</p> <p>Internal filter in main unit blocked</p> <p>Leak in probe cable</p> <p>Wrong flow limit or limit low flow error settings (for HIGH FLOW mode)</p>	<p>Replace sniffer tip filter and recalibrate! (see section 7.4)</p> <p>Replace internal filter* and recalibrate!</p> <p>Replace sniffer line (or: replace probe cable*) and recalibrate!</p> <p>Check flow limit settings and limit low flow error (for HIGH FLOW mode)! See section 4.4.1</p>

Error no.	Plain text message	Possible Reason	Recommendation
E55	Flow through sniffer below error limit	<p><u>Only for Protec P3000 or Protec P3000XL in LOW FLOW mode:</u> Flow through sniffer line below limit low flow error for LOW FLOW mode</p> <p>Filter in sniffer line blocked!</p> <p>Internal filter in main unit blocked</p> <p>Limit low flow error for LOW FLOW mode too high</p>	<p>Replace sniffer tip filter and recalibrate! (see section 7.4)</p> <p>Replace internal filter* and recalibrate!</p> <p>Check limit low flow error (for LOW FLOW mode)! See section 4.4.1</p>
E56	HIGH FLOW below error limit	<p><u>Only for Protec P3000XL in HIGH FLOW mode:</u> Flow through sniffer line below limit low flow error for HIGH FLOW mode or pressure at Wise Technology sensor lower than corresponding lower pressure limit</p> <p>Filter in sniffer line blocked!</p> <p>Internal filter in main unit blocked</p> <p>Limit low flow error for HIGH FLOW mode too high</p>	<p>Replace sniffer tip filter and recalibrate! (see section 7.4)</p> <p>Replace internal filter* and recalibrate!</p> <p>Check limit low flow error (for HIGH FLOW mode)! See section 4.4.1</p>
W59	EEPROM parameter queue overflow!	May occur if software "update" to older version is performed	Restart the Protec P3000, if problem persists, call nearest INFICON service representative!
W60	All EEPROM parameter lost! Please check your settings!	New EEPROM has been installed, EEPROM on motherboard is virgin	All settings in software menu are reset to default! Please enter your settings again!
		If message comes up repeatedly during start-up, EEPROM on motherboard is faulty	Replace EEPROM*
W61	EEPROM parameter initialized!	Software update performed and new parameters have been introduced	Acknowledge warning
		Newly introduced parameters are listed below warning	
W62	EEPROM parameter lost!	If message comes up repeatedly during start-up, EEPROM on motherboard is faulty	Replace EEPROM*
		Parameter has been modified during software update and reset to default value	Check setting of modified parameters in corresponding software menu and set to desired value!
		Affected parameters are listed below warning	
W64	There are outstanding warnings!	Acknowledged but still valid warnings will be repeated every 2 hrs or on each new power on	Please double-check the warnings!

Error no.	Plain text message	Possible Reason	Recommendation
W65	Wrong date set!	Wrong date in the Protec. Wrong Hex code entered to PRO-Check	Check the date in the Protec. Check the Hex code entered to PRO-Check
W66	New PRO-Check!	New PRO-Check reference leak installed in main unit	Please enter serial number and code. See Section 4.7, Replace PRO-Check
W67	PRO-Check will be expired on DD.MM.YYYY	Warning for pending expiration will be issued adjusting 14, 30, 60, or 90 days before actual expiration.	Please order new PRO-Check gas reservoir! (cat. no. 521-010) See Section 7.7.5
W68	PRO-Check expired!	PRO-Check has been used for more than 1 year or has been manufactured more than 2 years ago.	Please replace PRO-Check gas reservoir! See Section 7.7
W70	All EEPROM parameter of PRO-Check lost!	EEPROM in PRO-Check is empty or faulty	Replace PRO-Check!
W71	No communication with PRO-Check!	No or defective electrical connection between PRO-Check and main unit	Check connection of PRO-Check with main unit If problem persists, call nearest INFICON service representative!
		PRO-Check not installed in main unit	Install PRO-Check!
		No PRO-Check available	Disable PRO-Check in software menu (see Section 4.5.6)
W72	No communication with sniffer!	No or defective electrical connection between sniffer line and main unit	Check connection of sniffer line with main unit (disconnect and reconnect, if possible, try different sniffer line) If problem persists, call nearest INFICON service
W78	Signal difference between calibrated leak and air too small!	Calibrated leak too small / empty during calibration or proof	Check leak rate of test leak or use leak with higher leak rate
		Background too high during calibration	Check helium background See Section 4.6, Info page 2.
		Not enough time expired for air signal to stabilized (acknowledged too early)	Repeat calibration, allow sufficient time for air signal to stabilize!
W81	Calibration factor too low!	Calibration factor determined to be < 0.1 during calibration	
		Leak rate of test leak is incorrect (especially during external calibration)	Check correct setting of test leak value!
W82	Calibration factor too high!	Calibration factor during calibration determined to be > 10	
		Leak rate of test leak is incorrect (especially during external calibration)	Check correct setting of test leak value!
		Test leak not sniffed properly / not long enough	Repeat calibration, sniff test leak properly and for sufficient time

Error no.	Plain text message	Possible Reason	Recommendation
W86	Internal calibration not possible	Not in measure mode when calibration is attempted	Wait until Protec P3000 enters measurement mode!
W87	Not supported gas in PRO-Check	Occurs only during internal calibration or proof function: ECO-Check installed (accidentally) EEPROM in PRO-Check not programmed	Take out ECO-Check, install PRO-Check! Replace PRO-Check reference leak!
W88	PRO-Check defective	<u>Occurs only during internal calibration or proof function:</u> Temperature sensor defective	Replace PRO-Check reference leak!
W89	Overrange!	Protec P3000 is contaminated with helium	Do not switch off Protec P3000(XL)!!! Keep Protec P3000 running while providing fresh air to sniffer line until warning is cleared. If warning occurs frequently, increase contamination limit!
			Check helium background See Section 4.6, Info page 2.
			Use smaller test leak for external calibration!
W90	Calibration conditions not maintained	Sniffer removed during internal calibration, internal calibration aborted	Repeat calibration acknowledge

* To be performed only by authorized INFICON service personnel.

6 Equipment Connections

The Protec P3000 is equipped with three electrical control connectors. The electrical connections (head phone, I/O port and RS232) are located on the rear of the main unit directly next to the socket for the mains cable.

6.1 I/O Port (Control Inputs and Outputs)



Warning

For all contacts of the I/O Port a maximum voltage of 60 V DC or 25 V AC must not be exceeded or reached to ground or ground equipment conductors. According to the type of in- or outputs lower voltages had to be accepted. For this, please refer to the information given in the responding chapters.

Through this connection some functions of the Protec P3000 can be controlled externally or measurement data or the of the Protec P3000 status may be communicated to external equipment.

Through relay change over contacts the trigger levels as well as the operating mode (Ready) of the Protec P3000 may be monitored.

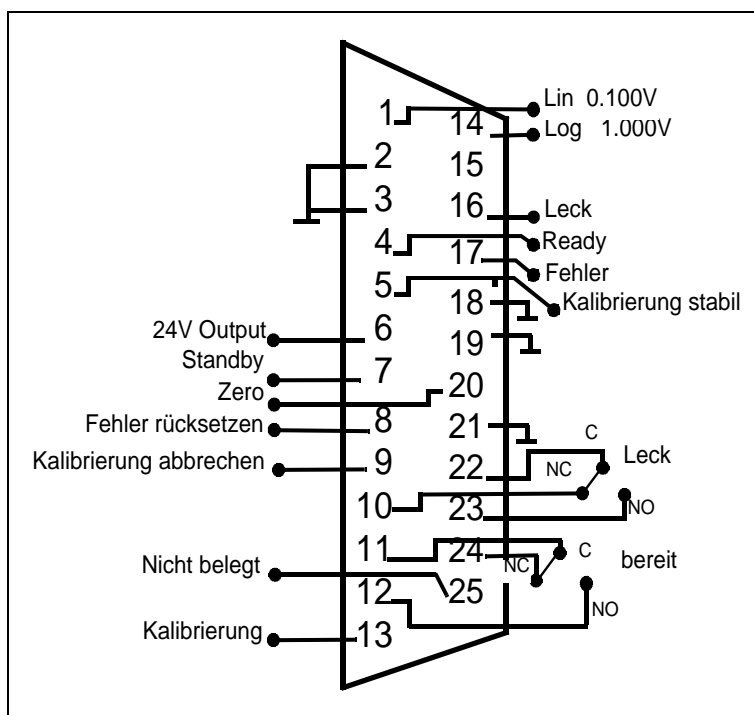

Fig. 6-1 Default Pin Assignment

6.1.1 Ground connectors

Pin 2, 3, 18, 19 and 21 are ground connectors.

6.1.2 24V Output

Pin 6 is a +24 V common output for supplying the PLC inputs and outputs, internally protected with fuse F4.

6.1.3 PLC Inputs

These inputs can be used to control the Protec P3000 via a programmable logic control (PLC).

Caution

Permissible maximum input voltage 28 V.

Technical data

24V nominal input
 Low level: 0 ...7 V
 High level: 13 ... 28 V

Pin assignment (default)

Pin	Default Command
7	Standby
8	Clear Error
9	Calibration Abort
13	Calibration
20	Zero
25	Not used

All PLC inputs can be defined by the user from a list of commands. The commands can be selected in the SETTINGS / INTERFACES / SELECT PLC INPUTS submenu. For details on this submenu please refer to Section 4.4.4. The currently selected commands can be viewed on INFO page #7.

Standby

Change from LOW to HIGH to activate STANDBY function.
 Change from HIGH to LOW to deactivate STANDBY function (wake up).

Calibration

Starts a calibration process and also confirms to proceed with the calibration after the signal from the test leak had enough time to stabilize and the sniffer tip has been moved away from the test leak (see timing chart for calibration below).

Calibration abort

Aborts a calibration any time during a calibration process.

Zero

Performs the ZERO function (equivalent to pressing the zero button)

Clear Error

Acknowledges any warnings or error messages. If used during an ongoing calibration, the calibration will be aborted.

6.1.4 PLC Outputs

These outputs can be used to monitor the Protec P3000 via a programmable logic control (PLC).

PLC Outputs are designed as an „Open Collector Output“ or a relay output. Please refer to the example given below for an open collector output „Error“.

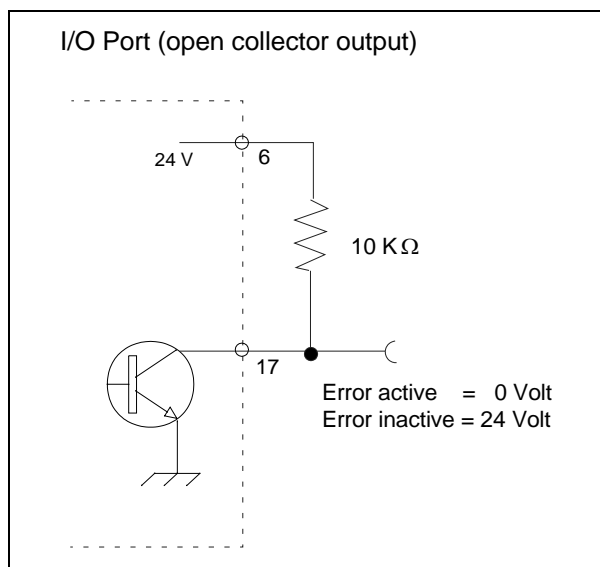



Fig. 6-2 Circuit for open collector output "Error"

Technical data

 Caution
Permissible max. voltage and current for open collector outputs are: 28 V; 50 mA.

Open collector output
Active = low

Pin assignment

Pin	Command (not editable)
4	Ready
5	Calibration stable
16	Leak
17	Error

Ready

Signal is LOW as long as the Protec P3000 is ready for measurements.

Calibration stable

Signal is LOW when the signal detected during a calibration had enough time to stabilize and goes back to HIGH after the background signal had enough time to stabilize

Leak

Signal is LOW if the preset trigger level is exceeded

Error

Signal is LOW if a warning or error message is active.

6.1.4.1 Relay outputs

Technical data



Caution

Maximum load rating is 60 V DC / 25 V AC and 1 A per relay.

Relay
Active Normally open (NO)

Pin assignment

Pin	Type of contact	Command (not editable)
22,10	Normally closed contact (NC)	Leak
22, 23	Normally open contact (NO)	
11,24	Normally closed contact (NC)	Ready
11,12	Normally open contact (NO)	

Leak

Relay is Active (NO) if the preset trigger level is exceeded

Ready

Relay is Active (NO) as long as the Protec P3000 is ready for measurements.

6.1.4.2 Recorder Outputs

Technical data

Analogue output
0 ... 10 V
max. 1mA

Pin assignment

Pin	Command
1	Leak rate, analogue output, linear scale
14	Leak rate, analogue output, logarithmic scale

For details please refer to section [4.5.2 \(Recorder outputs\)](#)

6.1.5 How to perform a calibration?

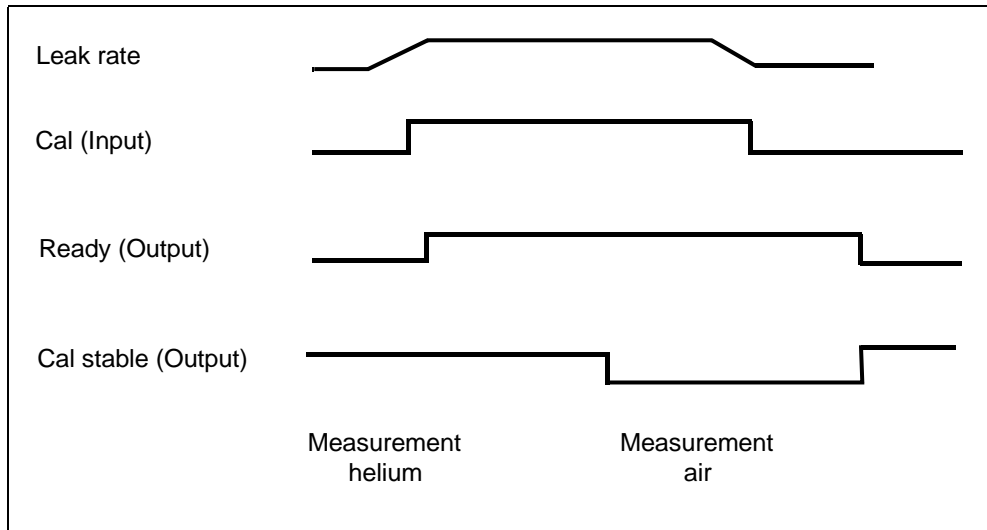

Fig. 6-3

A calibration process is started by setting the CALIBRATION input to HIGH after the sniffer probe tip has been placed in front of a test leak. The READY signal will go to HIGH after the calibration process has started.

Notice If a calibration is started within the first 20 min after power on a warning is issued. The ERROR output signal will go to LOW and the READY signal will go to HIGH (not ready). In this case, a calibration will not be started until the CLEAR ERROR input signal is set to HIGH (calibration will be started afterwards). Alternatively the calibration may be aborted by setting the CALIBRATION ABORT input signal to HIGH.

When the calibration process has been started the Protec P3000 sets the CALIBRATION STABLE output signal to LOW after the signal had enough time to stabilize. The sniffer probe tip then needs to be moved away from the test leak and the CALIBRATION input needs to be set back to LOW afterwards.

The CALIBRATION STABLE output signal stays LOW and is set back to HIGH when the background signal also had enough time to stabilize. At this time the calibration will be completed, the results of the calibration process will be shown on the main display for 3 seconds. After that the main display will go back into measurement mode. The READY output signal will go back to LOW at that time.

If ABORT is sent during a calibration before the last edge of the CALIBRATION signal, the calibration process will be aborted.

In case of an error during calibration, the READY output signal will remain HIGH until the error is erased by the CLEAR ERROR input signal.

6.2 *RS232 interface*

The RS232 interface can be used for external control of the Protec P3000 but also for simple export of data describing testing results.

For how to set-up the RS232 interface please refer to Section [4.5](#).

For a detailed description of the RS232 interface and its commands please refer to the "Protec P3000 Interface Description" (kins26e1)

7 Maintenance



Warning

For all maintenance on the Protec P3000, the main power must be disconnected first.

7.1 Maintenance schedule

Required tools

- 2 screw drivers, size 2
- 1 ring spanner wrench, 19 mm
- 8 mm hexagonal screw driver (delivered with Protec P3000).

Required maintenance	Sub Assembly	Material Description	Part no.	Operation hours			Repair level
				2000	5000	10.000	
Check sinter filter and replace if necessary	Sniffer tip	Sinter Filter for Sniffertip SL3xx, SL3000-x (5 pcs.)	200 03 500	X			I
Replace if W35 „Flow too low“	Sniffer tip	Felt for Capillary Filter SL3xx, SL3000-x (50pcs.)	200 001 116	1)			I
Check internal filter and replace if necessary	Main Unit	internal Filter (10 pcs.)	200 001 680			X	II
Maintenance of diaphragm pump	Diaphragm Pump MVP015	Wearing parts kit for Diaphragm pump	200 03 504			X	III
Clean or replace the air filter at the bottom of the chassis	Main Unit	Air Filter Protec P3000 (104x154 mm; 5 pcs.)	200 001 552		X		I
Replace gas reservoir after 1 year	PRO-Check	Replacement gas reservoir for PRO-Check	521-010	1)			I
Replace filter pad	Sniffer tip	SL3000-XL	200 002 251				I

Key for Maintenance Schedule:

- I Repair level I Customer
- II Repair level II Customer with technical training from INFICON
- III Repair level III INFICON service engineer

1) Depends on the environment

7.2 Exchanging the air filter



Caution

The air filter should be checked for contamination at least every 6 months and should be definitely exchanged after 2 years.



Warning

Before exchanging the filter the Protec P3000 must be disconnected from power.

To exchange the air filter, place the Protec P3000 on its front-side or position it on the edge of a sturdy bench. If placing it on the edge of a bench, please pay attention to its center of gravity. If placing it on its front-side, please remove the sniffer line and the built-in PRO-Check first.

Notice To prevent scratching of the front-cover, it is recommended to use a soft base.

- 1 The fastener for the air filter is on the bottom of the Protec P3000.



Fig. 7-1 Fastener for the air filter on the bottom of the leak detector

- 2 Screw out the fastener screw.

- 3** Extract the air filter.



Fig. 7-2 Dismounting of the air filter

- 4** Depending on the contamination the air filter should be cleaned or replaced as necessary.
- 5** Push in new (changed) air filter until fully in contact with dead stop.



Fig. 7-3 Inserting the air filter

- 6** Close air filter fastener.
- 7** From the main menu go to HISTORY & MAINTENANCE / CONFIRM MAINTENANCE and confirm with the appropriate button on the right side of the display that the air filter has been replaced / cleaned. The actual date and time as well as the actual number of operating hours will be saved and a reminder to perform this maintenance task again will be issued after another 10.000 operating hours.

7.3 Exchanging the external fuses



Warning

Before exchanging the fuses you must disconnect the mains cord.

Use a screw driver to fold out the lid of the mains socket from the right (the mains switch is not affected by this).

The fuses can be removed by pulling out the drawers which are marked by the arrows. On re-inserting these, make sure that the arrows point downward.

The two fuses must be replaced by two fuses of the same rating. The required mains fuses are available as cat.-no.

After having exchanged the fuse(s) firmly reclose the lid of the mains socket.

Re-connect the mains cord to the Protec P3000 and switch on the leak detector.

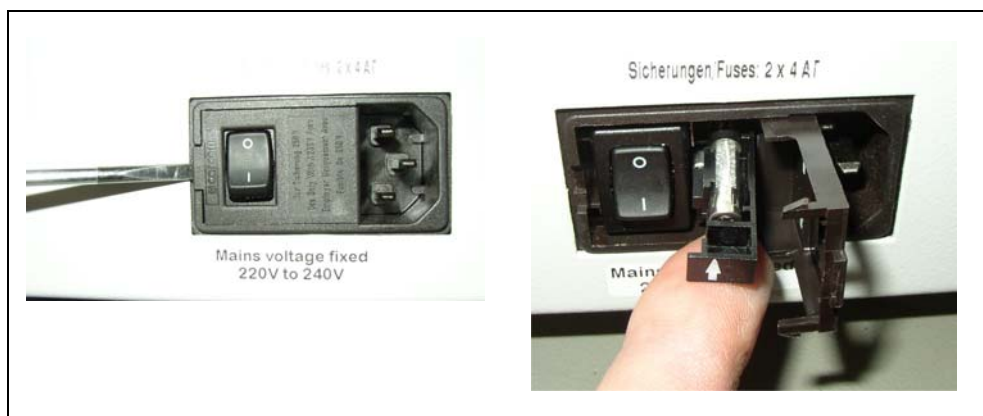

Fig. 7-4 Replacing the mains fuse

7.4 Replacing filters in the sniffer line

If the sniffer probe is clogged, a warning “Flow through capillary too low” (warning 35 or warning 41) will be issued.

Clogging of the sniffer probe may be due to:

- Clogging of capillary filter: see Section 7.4.1 (for SL3000 only)
- Clogging of sinter filter: see Section 7.4.3 (for SL3000 only)
- Clogging of sniffer tip filter (for SL3000XL only)
- Clogging of sniffer probe capillary
- Damage of sniffer tip
- Clogging / damage of sniffer line

7.4.1 Replacing the felt discs of the capillary filter (for SL3000 only)

 **Caution**
The Protec P3000 must be recalibrated after any maintenance of the sniffer tip!

- 1 Switch off the Protec P3000.

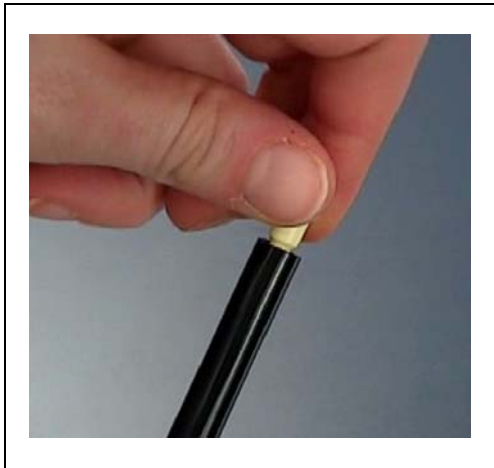

Fig. 7-5 screwing off capillary filter

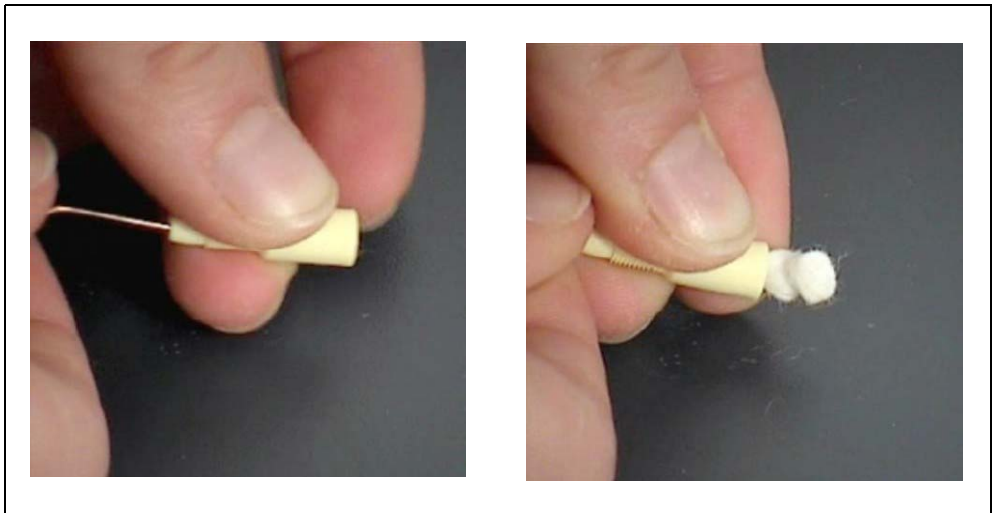

Fig. 7-6 pushing out felt filter

- 2 Unscrew capillary filter, push out old felt filter from the back side.



Fig. 7-7 old and new felt filter

- 3 Push in new felt filter.

Notice The metal grid is not included with the spare felt filter. Please clean the metal grid carefully and use it again.

- 4 Switch on the Protec P3000.
- 5 Hold finger against the capillary filter:
You should be able to feel the flow.
- 6 If warning "Flow through capillary too low" remains, replace the sinter filter (see Section 7.2)
- 7 From the main menu go to HISTORY & MAINTENANCE / CONFIRM MAINTENANCE / SNIFFER TIP FILTER and confirm with the ok button on the right side of the display that the sniffer tip filter has been replaced. The actual date and time as well as the actual number of operating hours will be saved and a reminder for maintenance will be issued again after the preset number of hours. For details see Chapter 4.5.

Notice The Protec P3000 must be set to ADVANCED mode for confirming maintenance tasks.

- 8 Please recalibrate the Protec P3000 for most accurate display of leak rate.

7.4.2 Replacing the felt discs when using the water protection tip (for SL3000 only)

- 1 Switch off Protec P3000!
- 2 Screw off water protection tip!
- 3 Push out filter pads and metal grid from the back side.
- 4 Re-install metal grid at the bottom of water protection tip.
- 5 Push in two new filter pads (all the way to the bottom of the water protection tip).
- 6 Switch on Protec P3000

Notice If the flow has changed by more than 30%, a re-calibration of the Protec P3000 will be required and a corresponding warning will be issued by the software.

- 7 From the main menu go to HISTORY & MAINTENANCE / CONFIRM MAINTENANCE / SNIFFER TIP FILTER and confirm with the OK button on the right side of the display that the sniffer tip filter has been replaced. The actual date and time as well as the actual number of operating hours will be saved and a reminder for maintenance will be issued again after the preset number of hours. For details see Chapter 4.5.
- 8 Please recalibrate the Protec P3000 for most accurate display of leak rate.

7.4.3 Checking / replacing the sinter filter (for SL3000 only)

Notice If the flow has changed by more than 30%, a re-calibration of the Protec P3000 will be required and a corresponding warning will be issued by the software.

- 1 Switch off the Protec P3000.
- 2 Remove the two Phillips screws and take off the sniffer tip.



Fig. 7-8 Taking off the sniffer tip

- 3 Remove the sinter filter with the o-ring.



Fig. 7-9 Sinter filter

- 4** Visually check the filter for contamination.
- 5** Install a new sinter filter with o-ring at the bottom of the filter tip.
- 6** Reinstall the sniffer tip.
- 7** Switch on the Protec P3000.
- 8** Hold finger against the capillary filter:
You should be able to feel the resulting vacuum.
- 9** If the warning "Flow through capillary too low" remains after releasing the finger from the capillary filter, replace the sniffer tip first. If this does not cure the problem, the capillary in the sniffer line is clogged and the complete sniffer line needs to be replaced.
- 10** Please recalibrate the Protec P3000 for most accurate display of leak rate.

7.5 Replacing the filter pad of the sniffer tip (for SL3000XL only)

When you want to change the filter pad, which is placed between sniffer tip and the handle, you have to take off the sniffer tip first:

- 1 Loosen the cap nut by turning it to the left.

Notice If the screw is too tight you may use a screw wrench (SW21):

- or:** Place a screw wrench at the recess of the cap nut and loosen the nut carefully by turning the wrench to the left.



Abb. 7-10 Switching of the handle and sniffer tip - without or with wrench

Notice Don't use the blue paper pads between each filter pad.

- 2 Remove filter pad.

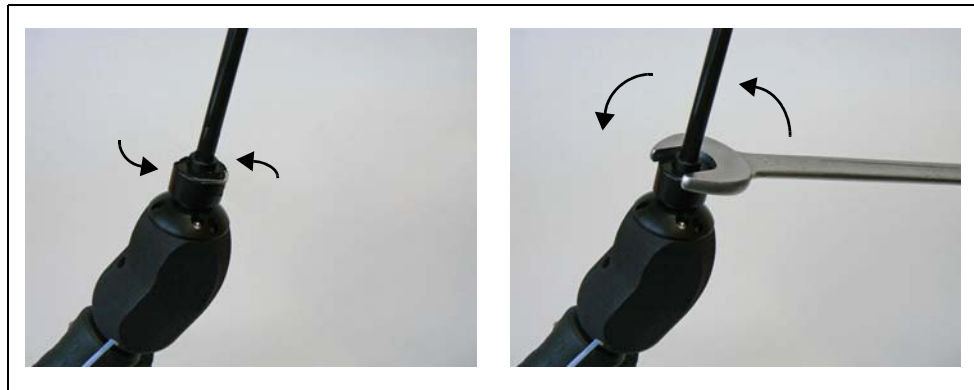

Abb. 7-11 Removed filter pad

- 3** Place new filter pad in the cap nut and press it in carefully. The filter pad works in each direction.



Abb. 7-12 Filter pad in cap nut

- 4** Put sniffer tip onto handle and screw tight with your hands.



Abb. 7-13 reassembly

Now you can use the Protec P3000XL as usual.

- 5** Installation Check:

Notice If you want to check if the new filter pad has been installed securely please perform the following test:

- 5a** Screw off the plastic cap at the end of the filter tip.
- 5b** Place thumb on end of sniffer tip and press to seal off the inlet.
- 5c** A warning (Protec P3000XL → W41 and LOW FLOW → W35) should be issued by the Protec P3000XL. If no W41 is issued, please tighten the cap nut more firmly and repeat the test. If still no W41 is issued, open again cap nut and check correct seating of filter pad.
- 5d** Release thumb and reinstall plastic cap at end of sniffer tip.
- 6** Please recalibrate the Protec P3000 for most accurate display of leak rate.

7.6 Switching the capillary filter (for SL3000 sniffer line only)

At the top of the sniffer tip two different capillary filters can be mounted.

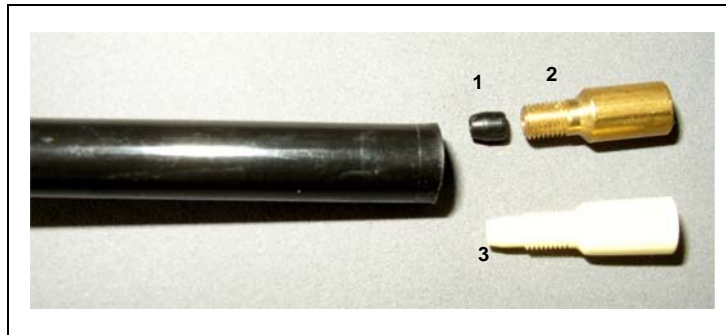

Fig. 7-14

Pos.	Description	Pos.	Description
1	Taper Gasket (can be black or white)	3	Plastic capillary filter
2	Metal capillary filter		

7.6.1 Switching from metal to plastic capillary filter

When you switch from the metal capillary filter to the plastic capillary filter you need to remove the taper gasket. The plastic capillary filter will not fit with the taper gasket installed.

- 1** Remove the two Philips screws in the flange of the sniffer tip and remove sniffer tip.
- 2** Take a small pin or needle (about 0.5 mm) and push the steel capillary out off the tip from the top.

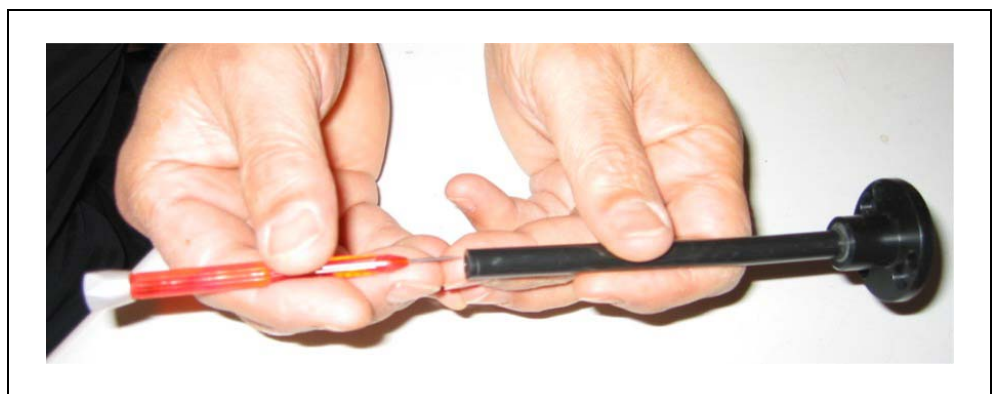

Fig. 7-15 Pushing out the steel capillary

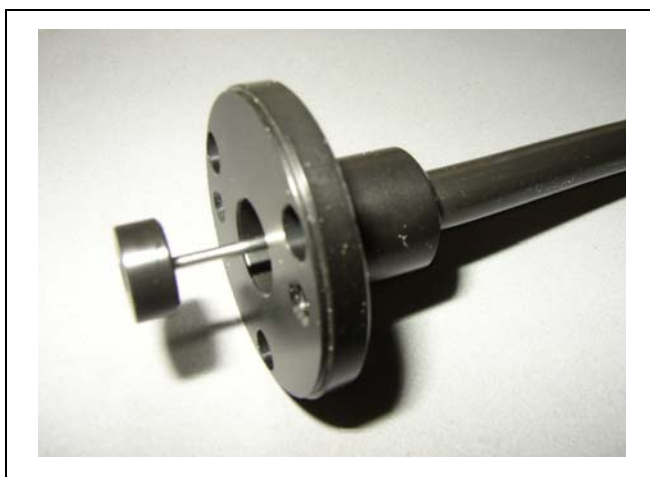

Fig. 7-16 Steel capillary sticking out of sniffer tip flange

The steel capillary may be removed in that way for the following sniffer tips:

cat. no.		length	
122 09	FT600	600 mm	flexible
122 13	ST312	120 mm	rigid
122 14	FT312	120 mm	flexible
122 15	ST385	385 mm	rigid
122 16	FT385	385 mm	flexible
122 18	FT200	200 mm	rigid
122 66	FT250	250 mm	flexible
122 72	ST500	500 mm	45° angled

- 3** Take out the steel capillary and remove the taper gasket at the top of the sniffer tip.

Notice The steel capillary can be cleaned with compressed air or a thin steel wire.

- 4** Reinsert the steel capillary and reinstall the sniffer tip.
- 5** Screw the plastic capillary filter onto the sniffer tip.
- 6** Please recalibrate the Protec P3000 for most accurate display of leak rate.

7.6.2 Switching from plastic to metal capillary filter

Notice When you switch from the plastic capillary filter to the metal capillary filter, do not forget to re-install the taper gasket as otherwise the SL3000 sniffer line will be leaky.

- 1** Unscrew the plastic capillary filter.
- 2** Insert taper gasket (Fig. Fig. 7-14/1)
- 3** Re-install the capillary in the sniffer tip.
- 4** Screw in metall capillary filter at the end of the sniffer tip.
- 5** Please recalibrate the Protec P3000 for most accurate display of leak rate.

7.7 Replacing the gas reservoir of the PRO-Check

Notice Please take off the lid from the new gas reservoir 48 hours before installation. Due to accumulation of gas in the membrane during storage, the leak rate will be higher than certified right after opening.

Do not use the new gas reservoir for calibration during this time.

- 1 Pull out the PRO-Check. The PRO-Check reference leak is fixed with magnetic holders and can be pulled out easily.



Fig. 7-17 Removing the PRO-Check reference leak from the main unit

- 2 Screw off the gas reservoir counter clockwise



Caution

Inside of the holder is a glass tube and one O-ring which protects the photocell against dirt. Pay attention to not loose or break this glass tube.

Notice If the glass tube is dirty, please clean it carefully.

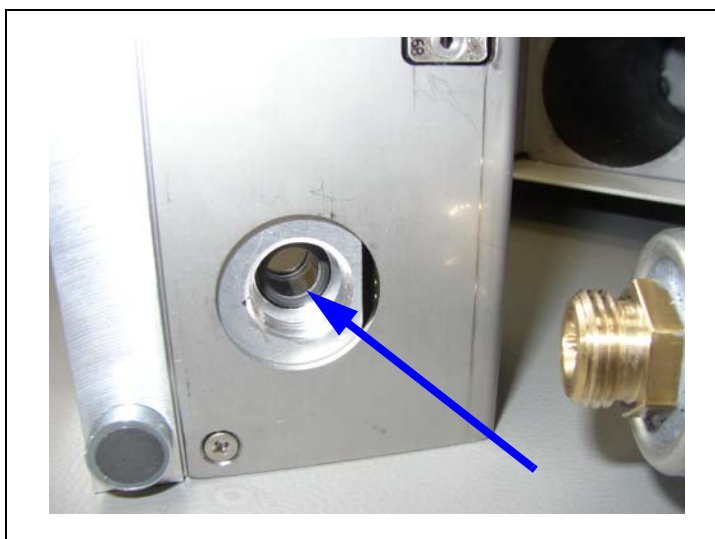

Fig. 7-18 O-Ring

3 Screw in the new reservoir.



Fig. 7-19 Installing the gas reservoir

Notice Screw in the new reservoir with hex nut key only!

4 Re-install the PRO-Check in the Protec P3000.

Notice The PRO-Check does not fit in the Protec P3000 completely. There is a little gap between the front panel of the Protec P3000 and the PRO-Check.

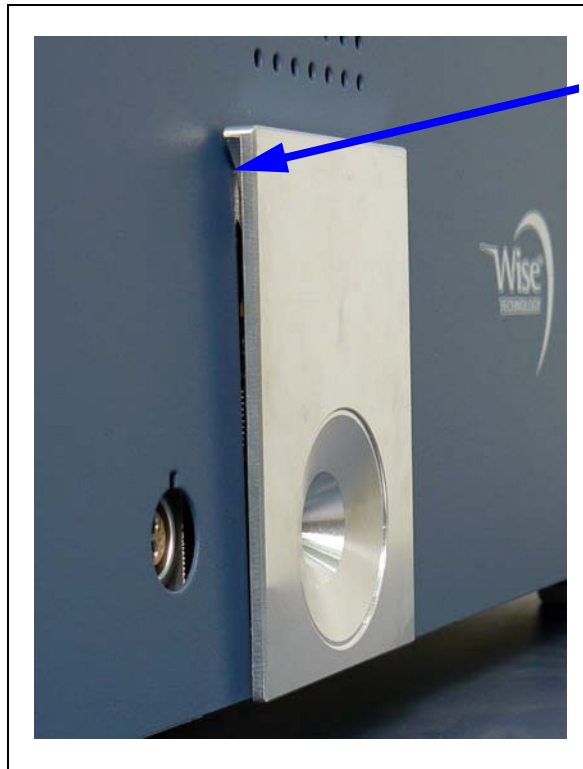

Fig. 7-20 Gap between PRO-Check and front panel

On the certificate which is delivered with the replacement gas reservoir you will find a new serial number and a 12-digit-code containing the new leak rate and other leak specific information. In the software menu please go to "HISTORY & MAINTENANCE / REPLACE PRO-CHECK". In the opening sub-menu enter the new serial number in the first line and the 12-digit-code in the second line and press okay.

Notice This submenu only is available if the Protec P3000 is set to ADVANCED mode (see Section 4.4.3, User Mode)

Notice The PRO-Check reference leak must be installed in the Protec P3000 when pressing OK.

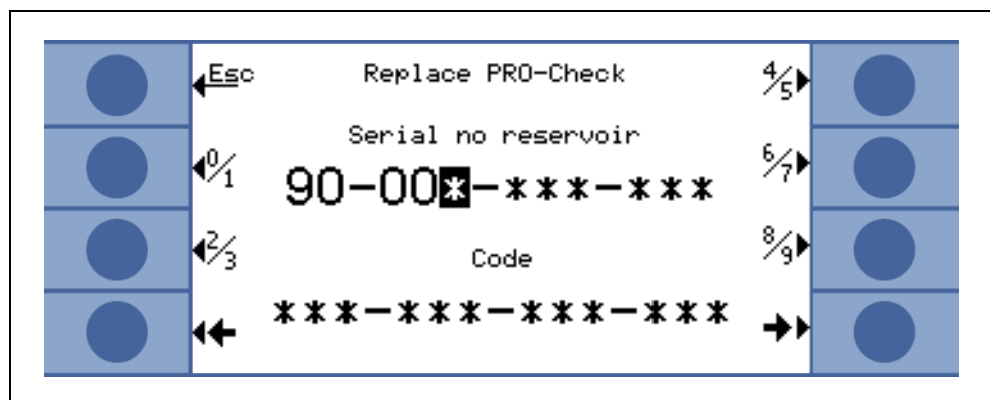

Fig. 7-21 Entry screen for replacing the PRO-Check

Notice Entering the new leak relevant codes is important as otherwise an accurate calibration with the internal test leak and traceability of the calibration cannot be guaranteed.

Notice The empty container is not reusable and should be disposed according to national law.

5 PRO-Check Warrtime Expire Date

The warning time for the exchange of the PRO-Check is adjustable in 14, 30, 60 or 90 days.

In the Main menu go to:

Settings → *Miscellaneous* → *PRO-Check warning time expiration date* → 14, 30, 60 or 90 days → OK.

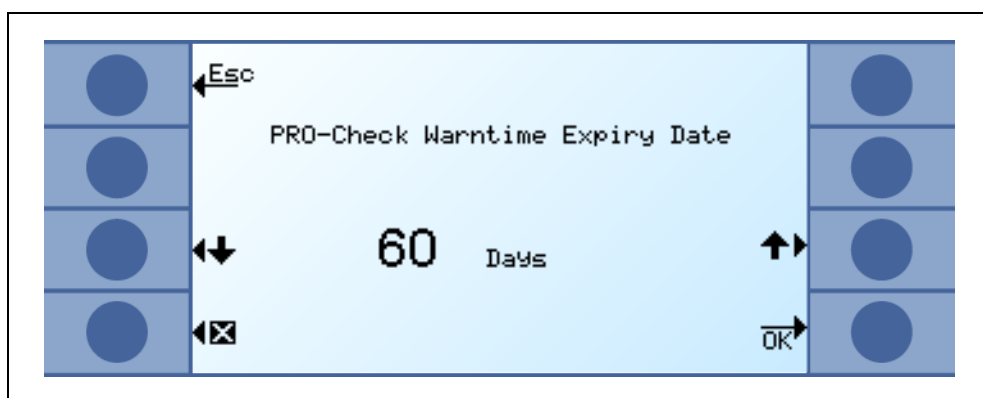

Fig. 7-22 The warrtime is adjustable

8 The gas library

The operating software of the Protec P3000 contains a list of about 100 gas equivalents which are relevant to the refrigerating industry. These gas equivalents are stored in a ROM (read only memory) and from the list contained in this memory gases and trigger levels may be selected through the corresponding sub-menus. The data contained in the ROM can not be changed. In addition, the program provides 40 unoccupied memory locations (user library EEPROM memory). Here the user may save the data of gases the parameters of which he has defined himself (see User Library). He may also select any gases defined earlier. The library of the Protec P3000 contains the following gases by default:

Gas designation (max. 5 digits)	Other Designations	Molecular mass (xxx.x amu)
R11	CCl ₃ F	137.4
R12	CCl ₂ F ₂	120.9
R12B1	CBrClF ₂ Halon 1211	164.0
R13	CBIF ₃	104.5
R13B1	CBrF ₃ Halon 1301	148.0
R14	CF ₄	80.0
R21	CHCl ₂ F	102.9
R22	CHClF ₂	86.5
R23	CHF ₃	70.0
R32	CH ₂ F ₂	52.0
R41	CH ₃ F	34.0
R50	CH ₄ Methane	16.0
R113	CClF ₂ CCl ₂ F	187.4
R114	CClF ₂ CClF ₂	170.9
R115	CClF ₂ CF ₃	154.5
R116	C ₂ F ₆	138.0
R123	CHClFCF ₃	152.9
R124	CHClFCF ₃	136.5
R125	CHF ₂ CF ₃	120.0

Gas designation (max. 5 digits)	Other Designations	Molecular mass (xxx.x amu)
R134a	CF ₃ CH ₂ F	102.0
R141b	CCl ₂ FCH ₃	117.0
R142b	CClF ₂ CH ₃	100.5
R143a	CF ₃ CH ₃	84.0
R152a	CHF ₂ CH ₃	66.1
R170	Ethane C ₂ H ₆	30.1
R218	C ₃ F ₈	188.0
R245fa	CF ₃ CH ₂ CF ₂ H	134.0
R290	Propane C ₃ H ₈	44.1
R356	Blend of CF ₃ (CH ₂) ₂ x CF ₃	166.1
R400	Blend of 50%R12 50%R114	141.6
R401A	Blend of 53% R22 13% R152a 34% R124	94.4
R401B	Blend of 61% R22 11% R152a 28% R124	92.8
R401C	Blend of 33% R22 15% R152a 52% R124	101.0
R402A	Blend of 38% R22 60% R125 2% R290	101.6
R402B	Blend of 60% R22 38% R125 2% R290	94.7
R403A	Blend of	92.0

Gas designation (max. 5 digits)	Other Designations	Molecular mass (xxx.x amu)
R403B	Blend of 56% R22 39% R218 5% R290	103.3
R404A	Blend of 44% R125 52% R143a 4% R134a	97.6
R405A	Blend of 45% R22 7% R152a 5.5% 142b 42.5% RC318	111.9
R406A	Blend of 55% R22 4% R600a 41% R142b	89.9
R407A	Blend of 20% R32 40% R125 40% R134a	90.1
R407B	Blend of 10% R32 70% R125 20% R134a	102.9
R407C	Blend of 23% R32 25% R125 52% R134a	86.2
R407D	Blend of 15% R32 15% R125 70% R134a	91.0
R407E	Blend of 25% R32 15% R125 60% R134a	83.8
R408A	Blend of 7% R125 46% R143a 47% R22	87.0
R409A	Blend of 60% R22 25% R124 15% R142b	97.4

Gas designation (max. 5 digits)	Other Designations	Molecular mass (xxx.x amu)
R409B	Blend of 65% R22 25% R124 10% R142b	96.7
R410A	Blend of 50% R32 50% R125	72.6
R410B	Blend of 45% R32 55% R125	75.6
R411A	Blend of 1.5% R1270 87.5% R22 11% R152a	82.4
R411B	Blend of 3% R1270 94% R22 3% R152a	83.1
R411C	Blend of 3% R1270 95.5% R22 1.5% R152a	83.4
R412A	Blend of 70% R22 5% R218 25% R142b	92.2
R413A	Blend of 9% R218 88% R134a 3% R600	104.0
R414A	Blend of 51% R22 28.5% R124 4% R600a 16.5% R142b	96.9
R415A	Blend of 82% R22 18% R152a	81.7
R416A	Blend of 59% R134a 39.5% R124 1.5% R600	111.9

Gas designation (max. 5 digits)	Other Designations	Molecular mass (xxx.x amu)
R500	Blend of 74% R12 26% R152a	99.3
R501	Blend of 75% R22 25% R12	93.1
R502	Blend of 49% R22 51% R115	111.6
R503	Blend of 40% R23 60% R13	87.3
R504	Blend of 48% R32 52% R115	79.3
R505	Blend of 78% R12 22% R31	103.5
R506	Blend of 55% R31 45% R114	93.7
R507A	Blend of 50% R125 50% R143a	98.9
R508A	Blend of 39% R23 61% R116	100.1
R508B	Blend of 46% R23 54% R116	95.4
R600	C ₄ H ₁₀ Butane	58.1
R600a	C ₄ H ₁₀ Iso-Butane	58.1
R601	C ₅ H ₁₂ Pentane	72.2
R601a	C ₅ H ₁₂ Iso-Pentane	72.2
R601b	C ₅ H ₁₂ Neopentane	72.2

Gas designation (max. 5 digits)	Other Designations	Molecular mass (xxx.x amu)
R601c	C ₅ H ₁₂ Cyclopentane	70.1
H2	Hydrogen	2.0
He	Helium	4.0
Air		29.0
NH3	R717	17.0
H2O	R718	18.0
Ne	Neon	20.2
N2	Nitrogen	28.0
O2	Oxygen	32.0
Ar	Argon	40.0
CO2	R744	44.0
Kr	Krypton	84.0
Xe	Xenon	131.3
SF6		146.1



EC Declaration of Conformity

We – INFICON GmbH - herewith declare that the products defined below meet the basic requirements regarding safety and health of the relevant EEC directives by design, type and the versions which are brought in to circulation by us.

In case of any products changes made without our approval, this declaration will be void.

The products meet the requirements of the following directives:

- **Directive on Low Voltage (2006/95/EC)**
- **Directive on Electromagnetic Compatibility (89/336/EEC and subsequent 93/68/EEC)**

Designation of the product:

Helium Leak Detector

Applied harmonized standards:

- **EN 61010 - 1 : 2001**
- **EN 61000-6-4 : 2002 Part EN 55011 Class A**
- **EN 61000-6-3 : 2002 Part EN 610003-2**
- **EN 61000-6-2 : 2000 Parts EN 61000-4-2
EN 61000-4-3
EN 61000-4-4
EN 61000-4-5
EN 61000-4-6
EN 61000-4-11**

Models: **Protec P3000**

Protec P3000XL

Protec P3000RC

Catalogue numbers:

- 520-001 520-103**
- 520-002 520-104**
- 520-003**
- 520-004**

During influence of strong electromagnetic interferences a temporary disturbance of the P3000 could occur.

Cologne, May 20, 2008

Dr. Döbler, Manager

Cologne, May 20, 2008

Finke, Research and Development

protec p3000.20.05.2008.engl.doc

INFICON GmbH
 Bonner Strasse 498 (Bayenthal)
 D-50968 Köln
 Tel.: (0221) 3474-0
 Fax: (0221) 3474-1429
 http://www.inficon.com
 e-mail:LeakDetection@inficon.com

Fig. 8-23 Declaration of Conformity

Appendix

A

accessories	1-1, 1-8
air filter	7-3
alarm	3-7, 4-14–4-15
alarm delay	4-21
ambient temperature	1-3
audio volume	3-2–3-3, 3-12
autozero	1-10

B

background	1-10, 2-4
basic menu	1-10

C

calibrated leak	1-9, 3-13
calibration	3-1–3-2, 3-4, 3-13, 3-15, 4-29
calibration factor	4-30, 5-7–5-8
calibration history	4-30
capillary filter	7-6
connector	2-6

D

dimensions	1-3
------------	-----

E

electrical connections	1-16
electrical connectors	6-1
error	3-12, 4-29, 5-1
error list	4-29
error messages	5-1
error no.	5-1
external calibration	3-16

F

filter	7-5
flow	1-3, 4-9, 4-26, 4-29, 5-3, 7-5, 7-9
flow limit	4-9
fuse	1-7, 1-16, 5-1, 7-5

G

global trigger	4-18–4-19
----------------	-----------

H

history	4-29
---------	------

I

I/O Port	1-16–1-17, 6-1
I/O port	4-21
I•Guide	3-8–3-9, 4-17
I•Guide mode	1-10
Info button	3-2
info button	3-4
installation	1-11
interface	2-2, 4-21
internal calibration	3-15

L

language	4-20
leak rate	4-24
lemo connector	1-11
loudspeaker	4-14–4-15

M

maintenance	7-1
menu	1-10
menu button	3-3

O

output	4-21, 6-1
--------	-----------

P

PIN	4-2, 4-13
PRO-Check	1-7, 1-9, 1-11, 2-5–2-6, 3-13–3-15
proof function	3-14

R

recorder output	4-21
right probe button	2-4, 3-5, 3-10, 3-12, 3-14–3-15, 4-24

RS232 interface	1-16, 4-21, 6-7
RS232 protocol	4-24

S

self-test	3-13
sinter filter	7-7
sniffer	4-27
sniffer light	4-20
sniffer line	1-11–1-12, 2-4, 4-9, 4-26, 7-5
sniffer probe	1-1, 2-4, 3-5, 7-5
sniffer tip	0-6, 1-8, 3-5, 3-10, 3-14–3-16
sniffer tips	1-8
Standby Delay	4-13

T

transportation lock	1-11
trigger	4-8, 4-24

V

verification	3-13
--------------	------

W

warning	3-12, 5-1
weight	1-3

Z

zero	1-10, 2-4, 3-4–3-7, 4-8
zero button	2-4, 3-4, 3-6, 3-10
zero time	4-8



INFICON GmbH, Bonner Strasse 498, D-50968 Cologne, Germany

UNITED STATES TAIWAN JAPAN KOREA SINGAPORE GERMANY FRANCE UNITED KINGDOM HONG KONG

Visit our website for contact information and sales offices worldwide.

www.inficon.com

Dokument: kina26e1-p (1209)