

Interface Description



Ecotec E3000

Leak Detector

Reprint, translation and reproduction require the written permission of the INFICON GmbH.

Table of Contents

1	About this manual	5
1.1	Target groups	5
1.2	Other associated documents	5
1.3	Warnings	5
<hr/>		
2	I/O Port	7
2.1	Connecting the I/O Port	7
2.1.1	PLC inputs	8
2.1.2	PLC outputs	9
2.1.3	Recorder outputs	10
2.2	Interface settings at the Ecotec E3000	10
2.2.1	Recorder outputs	10
2.2.2	Setup PLC	12
2.2.2.1	Define PLC Inputs	12
2.2.2.2	Define PLC Outputs	12
2.3	Example: How to perform a calibration	13
<hr/>		
3	RS-232 interface	15
3.1	Connecting the RS-232 interface	15
3.2	Interface Commands	16
3.2.1	Command Format	16
3.2.2	List of Commands	17
3.2.3	Error Messages	26
3.3	Interfaces settings at the Ecotec E3000	26
3.3.1	Control location	26
3.3.2	RS-232 Protocol	26
3.3.3	Interface Parameters: Baud rate & end sign	27
3.4	Examples of programming	28
3.4.1	Operating in measurement mode	28
3.4.2	Performing an external calibration	29
<hr/>		
4	Trouble Shooting	33

1 About this manual

1.1 Target groups

This Interface Description is intended for the owner and for technically qualified personnel with experience in leak detection technology and integration of leak detection devices in leak detection systems. In addition, the installation and use of the unit require knowledge of electronic interfaces.

1.2 Other associated documents

Operating instructions Ecotec E3000 kina22e1 (1312)

You may connect and use the Ecotec E3000 only with other devices, if you have read and understood the operating instructions of the Ecotec E3000.

1.3 Warnings



DANGER

Imminent threat of danger resulting in death or severe injuries



WARNING

Dangerous situation potentially resulting in death or severe injuries



CAUTION

Dangerous situation resulting in minor injuries

NOTICE

Dangerous situation resulting in damage to property or the environment

2 I/O Port

The I/O part allows communication with external equipment via analog data (programmable logic control - PLC). Through this connection some functions of the Ecotec E3000 can be controlled externally or measurement data or the Ecotec E3000 status may be communicated to external equipment. Through relay changeover contacts the trigger levels as well as the operating mode (Ready) of the Ecotec E3000 may be monitored.

2.1 Connecting the I/O Port

WARNING

Hazardous voltage.

The wrong voltage may destroy the device and violate people.

- ▶ For all contacts of the I/O Port a maximum voltage of 60 V DC or 25 V AC must not be exceeded or reached to ground or ground equipment conductors. According to the type of in- or outputs lower voltages had to be accepted. For this, please refer to the information given in the corresponding chapters.

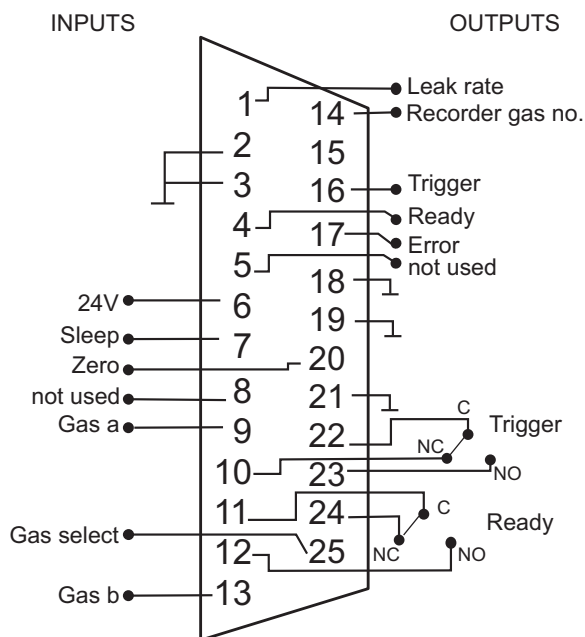

Fig. 1: Default pin assignment

Table 1: I/O Port - pin assignment

Pin	Signal	Notes	
2, 3, 18, 19, 21	Ground	Ground connectors of the control voltages.	
6	+24 V	Common output for supplying the PLC inputs and outputs, internally protected with fuse F4	
PLC inputs			
7	Sleep (default)	Change from low to high to activate. Change from high to low to deactivate (wake up).	See also technical data and further informations given below. All PLC inputs can be defined by the user from a list of commands, see „2.2.2.1 Define PLC Inputs“, page 12.
8	Not used (default)		
9	Gas a (default)	See table „Gas select“	
13	Gas b (default)	See table „Gas select“	
20	Zero (default)		
25	Gas select (default)	See table „Gas select“	
PLC outputs, open collector			
4	Ready (default)	Signal is LOW as long as the device is ready for measurements.	These PLC outputs are designed as „Open Collector Outputs“. Please refer to the technical data and the example given below. All PLC outputs can be defined by the user from a list of commands, see „2.2.2.2 Define PLC Outputs“, page 12.
5	not used (default)		
16	Trigger (default)	Signal is LOW if the preset trigger level is exceeded.	
17	Error (default)	Signal is LOW if a warning or error message is active.	
PLC outputs, relay			
10	Trigger (default)	Currentless closed (NC)	These PLC outputs are designed as relay outputs. Please refer to the technical data and and further informations given below.
22		Common	
23		Currentless open(NO)	
24	Ready (default)	Currentless closed (NC)	
11		Common	
12		Currentless open (NO)	
Recorder outputs			
1	Leak rate	Leak rate in linear or logarithmic scale	Please refer to the technical data and and further informations given below.
14	Gas	Selected gas number	

2.1.1 PLC inputs

Technical data PLC inputs

NOTICE

Material damage if the input voltage is too high.

A wrong input voltage can destroy the unit.

► Pay attention to the technical data of the PLC inputs: Maximum input voltage is 28 V.

- 24 V nominal input.
 - Low level: 0 ... 7 V
 - High level: 13 ... 28 V

Gas select, gas a, gas b

Through the control inputs Gas ... (pin 9, 13 and 25) it is possible to select a gas loaded in the active gas memory (one gas out of four). The Ecotec E3000 will then operate in the single gas mode.

With an edge triggered signal from LOW to HIGH at Pin 25, the selected gas at Pin 13 and 9 becomes valid.

Table 2: Gas select

Pin 25	Pin 13	Pin 9	Function
0	X	X	Gas selecting disabled
1	0	0	1 st gas is selected
1	0	1	2 nd gas is selected
1	1	0	3 rd gas is selected
1	1	1	4 th gas is selected

2.1.2 PLC outputs

Technical data open collector outputs

NOTICE

Material damage if voltage or current are too high.

Wrong voltage or current can destroy the unit.

► Pay attention to the technical data of the open collector outputs: Permissible max. voltage and current for open collector outputs are: 28 V; 50 mA.

Open collector output

Active = low

Example: Open collector output „Error“.

I/O Port (open collector output)

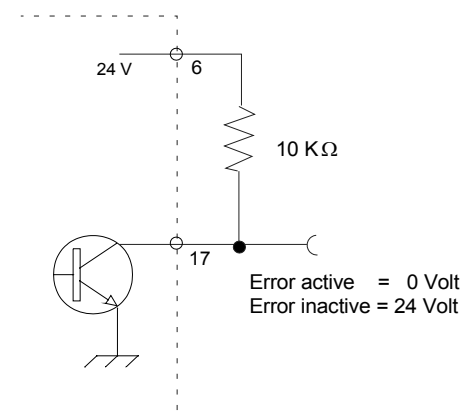

Fig. 2: Circuit for open collector output "Error"

Technical Data relay outputs

NOTICE

Material damage if load is high.

Wrong input voltage or current can destroy the unit.

- ▶ Pay attention to the technical data of the relay outputs: Maximum load rating is 60 V DC / 25 V AC and 1 A per relay (resistive load).

Relay output

Active = Normally open contact (NO) closed

Trigger

If the preset trigger level is exceeded, relay contact NO will close and the relay contact NC will open respectively.

Ready

As long as the Ecotec E3000 is ready for measurements, the relay contact NO is closed and the relay contact NC is open respectively.

2.1.3 Recorder outputs

Analogue output

0 ... 10 V

max. 1 mA

2.2 Interface settings at the Ecotec E3000

At "Settings > Interfaces" you make the settings for the interfaces.

2.2.1 Recorder outputs

For the recorder output the "Recorder Output Scale" and the "Recorder Output Gas" can be selected.

The "Recorder Output Scale" can either be linear or logarithmic. The output signal is provided through channel 1 (pin 1 of the I/O port).

Which of the 4 gases is indicated here is defined through the menu line "Recorder Output Gas".

Recorder output scale

LIN

The voltage range spans from 0 V to 10 V.

The leak rate which is output is normalized with respect to the trigger level for the corresponding gas. The trigger level will correspond to an output of 1 V. Higher and smaller leak rates may be output as a voltage deviating by a corresponding factor with reference to the trigger level.

Example:

The trigger level of the corresponding gas has been set to 3 g/a.

leak rate = 0.3 g/a → $U_{\text{analog}} = 0.1 \text{ V}$

leak rate = 3 g/a → $U_{\text{analog}} = 1.0 \text{ V}$

leak rate = 10 g/a → $U_{\text{analog}} = 3.3 \text{ V}$

Voltages over 1 V indicate that the trigger level has been exceeded.

LOG The voltage range spans from 0 V to 10 V. Beginning at 1 V, each leak rate decade is spread over 2 V, i.e.:

- 1.0 ... < 3 V: 1st decade
- 3.0 ... < 5 V: 2nd decade
- 5.0 ... < 7 V: 3rd decade
- 7.0 ... < 9 V: 4th decade

Thus a leak rate range of 4 decades will be output by way of an analogue signal. The four decades are set through the value and the unit of measurement for the trigger level.

The software of the Ecotec E3000 will set the output voltage in such a manner that the trigger level itself will always be set within the second decade (i.e. within the range of 3 to 5 V).

Table 3: Example, Trigger level and output voltage

Trigger level	Output voltage (1 ... 9 V) will correspond to
3 g/a	0.1 ... 1000 g/a
0.2 oz/yr	0.01 ... 100 oz/yr
5×10^{-4} mbar l/s	$1 \times 10^{-5} \dots 1 \times 10^{-1}$ mbar l/s

The following table has been provided to clarify the way in which the output voltage represents the leak rate.

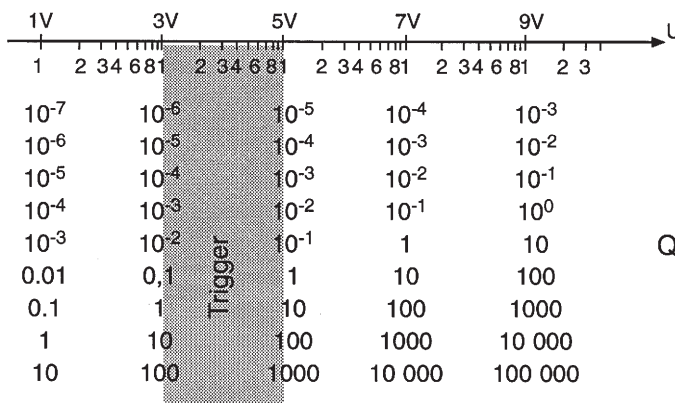

Further examples:

For a trigger level of 2 g/a a leak rate of 8 g/a is represented by an output voltage of 4.81 V:

$$U = 3 + 2 \cdot \log 8$$

(The factor of 2 is used since one decade is spread over 2 Volts. The summand of 3 is used because the trigger level will always be within the range of 3 to 5 V).

Table 4: Trigger level, leak rate and output voltage

Trigger	Leak rate	Output voltage
0.1 oz/yr	1.5 oz/yr	→ 5.35 V
3 g/a	20 g/a	→ 5.60 V
	50 g/a	→ 6.39 V
5×10^{-4} mbar l/s	8×10^{-5} mbar l/s	→ 2.806 V
	6×10^{-3} mbar l/s	→ 6.556 V

Default setting: logarithmic

Recorder output gas

Here one gas from the four gases is defined which will be output as the analog signal through channel 1.

Selecting one of the numbers 1 ... 4 outputs the corresponding gas 1 ... 4 on the display as the analog signal.

Channel 2 (pin 14 of the I/O port) indicates the gas number by way of a voltage, i.e. a voltage between 1 ... 4 V will be present accordingly.

When selecting "auto" the leak rate which has the highest value with reference to the corresponding trigger level is output as the analog signal. Correspondingly the voltage in channel 2 will differ accordingly.

In the modes "ERROR", "NOT READY TO MEASURE" and "SLEEP" a voltage of U = 10 V will be output through channels 1 and 2.

Default setting: auto

2.2.2 Setup PLC

In the "Setup PLC" submenu you can define the PLC Inputs and PLC outputs.

2.2.2.1 Define PLC Inputs

In the "Define PLC Inputs" submenu the user can define which pin on the I/O port (suitable for PLC input) represents which command. The default setting is as follows:

Table 5: PLC input, pin - command assignment

Pin	Command	Pin	Command
7	Sleep	13	Gas b
8	Not used	20	Zero
9	Gas a	25	Gas select

To change these settings select the appropriate pin with the UP and DOWN arrows on the left side of the display and afterwards select the desired command from the list of commands with the UP and DOWN buttons on the right side of the display. Press OK to save your settings. A screen with all selected settings will be displayed for your reference. Confirm with OK again.

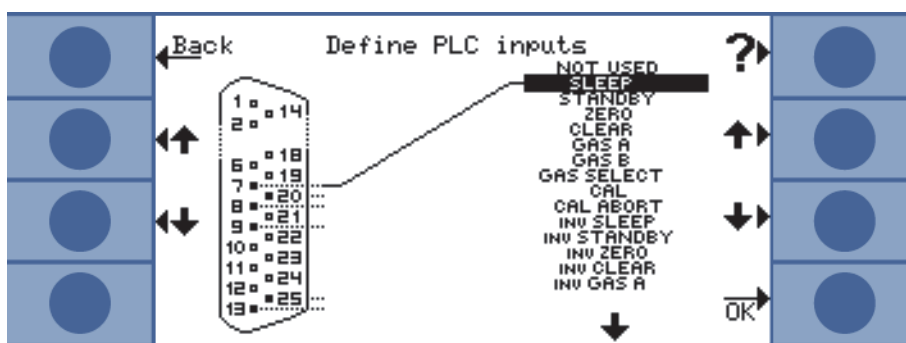

Fig. 3: Defining PLC-Inputs from list of possible commands

2.2.2.2 Define PLC Outputs

In the "Select PLC Outputs" submenu the user can define which pin on the I/O port (suitable for PLC output) represents which command. There are four PLC outputs and two relays outputs available. The default setting is as follows:

Table 6: PLC Output, pin - command assignment

Pin	Command	Pin	Command
4	READY	16	TRIGGER
5	not used	17	ERROR

Table 7: Relays outputs

Pin	Type of contact	Relay Output (default)
10	Currentless closed (NC)	TRIGGER
22	Common	
23	Currentless open (NO)	
24	Currentless closed (NC)	READY
11	Common	
12	Currentless open (NO)	

To change these settings select the appropriate pin with the UP and DOWN arrows on the left side of the display and afterwards select the desired command from the list of commands with the UP and DOWN buttons on the right side of the display. Press OK to save your settings. A screen with all selected settings will be displayed for your reference. Confirm with OK again.

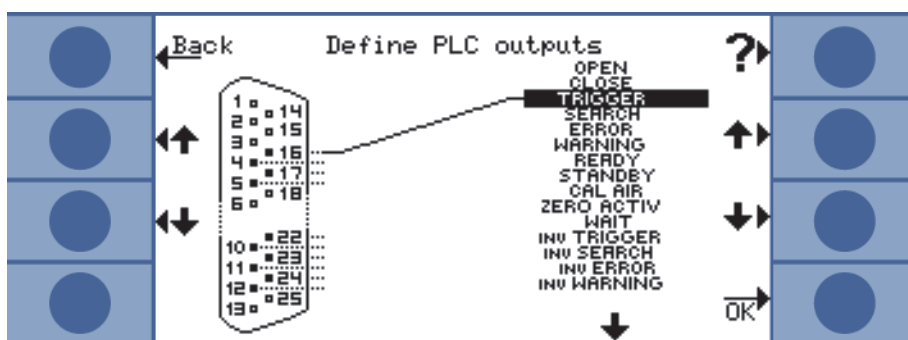

Fig. 4: Defining PLC outputs

2.3 Example: How to perform a calibration

An external calibration may be performed via the PLC inputs and outputs. For this purpose, one of the inputs needs to be configured to “CAL”, another needs to be set to “CAL AIR”. The external calibration is always performed for the enabled gas with the highest gas no. The test leak rate used is the test leak rate which has been used for the last external calibration performed.

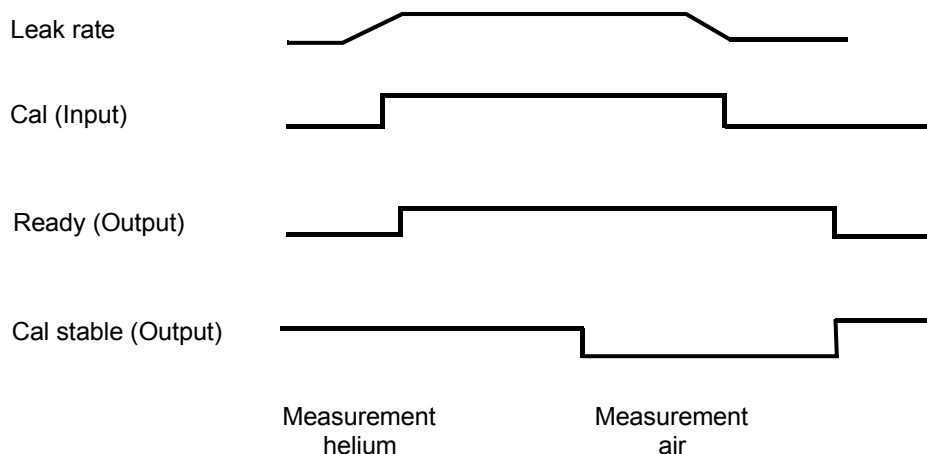

Fig. 5: Calibration timing interval

A calibration process is started by setting the calibration input to HIGH after the sniffer probe tip has been placed in front of a test leak. The ready signal will go to HIGH after the calibration process has started.

If a calibration is started within the first 20 min after power on a warning is issued. The ERROR output signal will go to LOW and the READY signal will go to HIGH (not ready). In this case, a calibration will not be started until the CLEAR ERROR input signal is set to HIGH (calibration will be started afterwards). Alternatively the calibration may be aborted by setting the CALIBRATION ABORT input signal to HIGH.

When the calibration process has been started the Ecotec E3000 sets the CALIBRATION STABLE output signal to LOW after the signal had enough time to stabilize. The sniffer probe tip then needs to be moved away from the test leak and the calibration input needs to be set back to LOW afterwards.

The CALIBRATION STABLE output signal stays LOW and is set back to HIGH when the background signal also had enough time to stabilize. At this time the calibration will be completed, the results of the calibration process will be shown on the main display for 3 seconds. After that the main display will go back into measurement mode. The READY output signal will go back to LOW at that time.

In case of an error during calibration, the READY output signal will remain HIGH until the error is erased by the CLEAR ERROR input signal. If ABORT is sent during a calibration before the last edge of the CALIBRATION signal, the calibration process will be aborted.

3 RS-232 interface

The Ecotec E3000 is equipped with a RS-232 interface which is located on the rear right side of the instrument. This interface is of the DCE type (Data Communications Equipment) and allows the connection of a PC for monitoring and data logging. The connection is provided through a commercially available Sub-D plug.

The RS-232 protocol can be set to "ASCII", "Diagnostics", "Printer auto" or "Printer manual". The ASCII protocol is a protocol similar to the SCPI, a standard protocol widely used for measuring equipment. The Diagnostics protocol is a binary protocol used for analysis in quality control and trouble shooting during manufacturing and service.

3.1 Connecting the RS-232 interface

A standard RS-232 cable can be used (straight-through connecting cable, RxD and TxD not crossed). The RS-232 hardware handshake must be switched off (in RS-232 control program written by the user). If switching off of the hardware handshake is not possible, an RS-232 connecting cable wired as follows may also be used:

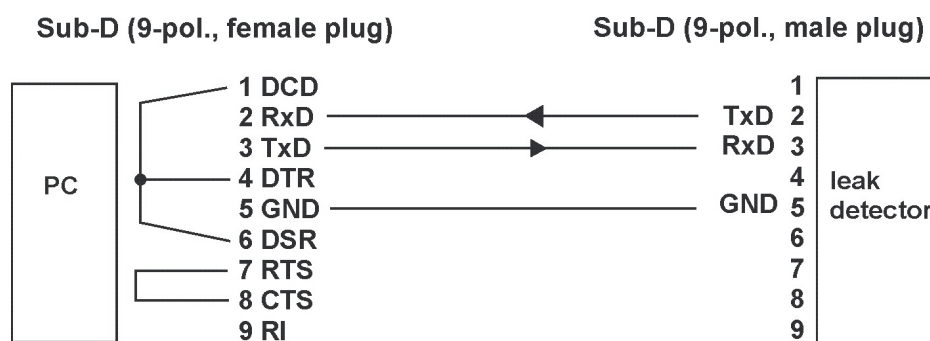

Fig. 6: RS-232 cable

Table 8: RS-232 Pin assignment

Pin	Name	Signal
2	RXD	Receive data (Ecotec E3000 → PC)
3	TXD	Transmit data (PC → Ecotec E3000)
5	GND	Reference ground

The levels on the RS-232 interface are defined as follows.

Table 9: RS-232 Level definition

Level	Low (L)	High (H)
Voltage range	-3 V ... -25 V	3 V ... 25 V
Logic state	logical 1	logical 0
Level designation	Mark	Space

3.2 Interface Commands

3.2.1 Command Format

In ASCII mode any command starts with « * (ASCII code 42 dec)» and is finished with the end sign selected (e.g. CR). There is no differentiation between upper and lower case (exception: gas names and names of I-Guide programs). A blank is required between the command and the parameter, no other blanks are allowed (except names of I-Guide programs).

There is a short and an extended form of the command. Either the short or the extended command must be used, no other abbreviations are allowed. Command Words have to be separated by a colon. A command can be composed of up to three words. Parameters have to be separated by a comma.

Each command is answered with "ok" or "EXX" (in case of an error). For a list of all error message see Operating Instructions of the Ecotec E3000. The transmission can be cancelled with ESC (ASCII code 27dec), ^C (ASCII code 3 dec) or ^X (ASCII code 24 dec).

Some commands can be used as queries, some can be used to set menu parameter and some can be used for both. A query is marked by a "?" (ASCII code 63 dec)" after the command, for setting data the command has to be followed by the new value to be set.

Parameter can be Boolean or numerical:

	Boolean	0 / 1 or OFF / ON Or ENAbLe / DISAbLe
<No>	Numeric representation format: integer, real (15.6) or exponential (4.5E-7) Format: [space] [sign] [ddd] [.] [ddd] [e[sign]ddd] (d: digit)	

Always use a point as the decimal marker. If a comma is used during numerical data entry, the conversion of the number is cancelled at this point and only the integer part of the number will be used.

Commands in brackets - as in *status[:CAL] - are optional commands and do not necessarily need to be transmitted.

Table 10: Examples

Command	Reply	Content
*stat? (CR)	MEAS (CR)	status of the unit
*status? (CR)	MEAS (CR)	status of the unit
*read 1? (CR)	14.3 g/a (CR)	leak rate gas 1 in chosen unit of measurement
*read 1:oz/yr? (CR)	2.876E-5 oz/yr (CR)	leak rate gas 1 in different unit of measurement
*start (CR)	OK (CR)	start run-up
*gas:1:search? (CR)	90 (CR)	query search level gas 1
*gas:1:search 75 (CR)	OK (CR)	set search level gas 1

3.2.2 List of Commands

The following table lists all commands available in the ASCII mode.

Table 11: List of commands, ASCII

Command word1	Command word2	Command word3	Statement	Read/Set
*CAL			external calibration	-
	:ESC		escape	S
	:FACTor		calibration factor	R
		:NEW	actual calibration factor	R
		:OLD	last calibration factor	R
	:FLOW		flow at calibration	R
		:NEW	flow at actual calibration	R
		:OLD	flow at last calibration	R
	:LEAKrate		leak rate (test leak)	R/S
	:POSition		mass position	R
		:NEW	mass position at actual calibration	R
		:OLD	mass position at last calibration	R
	:QUIT		acknowledge (proceed)	S
	:READ		signal (for stability observation)	R
	:SElect		gas selection (1 ... 4; only enabled gases)	R/S
	:START		start (switch from PROOF to CAL)	S
	:STATus		Status (plain text) "T<20MIN, CONFIRM" "SELECT GAS" "START CAL, CONFIRM" "EDIT LEAKRATE" "LEAK STABLE, CONFIRM" "AIR STABLE, CONFIRM" "PROOF FINISHED, CONFIRM" "PEAK (xx), CONFIRM" "ERRxx, CONFIRM" "WAIT" "REMOVE SNIFFER"	R
	:UNIT		unit (test leak)	R/S
*CLS			clear error	R
*CONFig				
	:AUDio		audio alarm type (TRIGger, SETpoint, PINpoint)	R/S
	:AUDIOType		type trigger / alarm (1, 2, 3)	R/S
	:BAUD		baudrate ASCII mode (1200, 2400, 4800, 9600, 19200)	R/S
	:BEEP		beep-sound (ON, OFF)	R/S
	:BRIGHtness		sniffer light brightness (1 ... 6)	R/S
	:CALAccess		CAL enable (ON, OFF)	R/S
	:CONTRast		contrast of main display (0 ... 99)	R/S
	:CONTROL		control location (LOCAL, RS232, LOCAL/RS232)	R/S
	:DELay		alarm delay (0.0 ... 9.9) [s]	R/S

Table 11: List of commands, ASCII (cont.)

Command word1	Command word2	Command word3	Statement	Read/Set
	:ECOcheck		ECO-Check (ON, OFF)	R/S
	:ENDsign		end sign (CR, LF, CR LF)	R/S
	:FILament		filament (A, B)	R/S
	:FILTer		filter type (AUTO, FIXed, I-Filter)	R/S
	:FLOWHigh		flow limit high [sccm] (160 ... 999)	R/S
	:FLOWLow		flow limit low [sccm] (0 ... 160)	R/S
	:INVERSE		Reverse colour of the main unit display	R/S
	:LANGuage		language (ENGLISH, DEUTch, FRANcais, ITALiano, PORTugese, ESPAnol, Japanese in KATakana, CHInese)	R/S
	:MAINTenance		maintenance plan (ON, OFF)	R/S
	:MODE		Gas configuration for the four gases (example: ON, OFF, OFF, OFF)	R/S
	:LIGHT		sniffer light (ON, OFF)	R/S
	:PROGram		I-Guide program number (disabled, 1 ... 10)	R/S
	:PEAKhold		show maximum peak (ON, OFF)	R/S
	:PEAKTime		Peak hold time (2, 3, 4, ... 20)	R/S
	:PLCINlink	:7 :20 :8 :9 :25 :13	Configuration of the PLC inputs NOT_used SLEEP STANDBY ZERO CLEAR GAS_A GAS_B GAS_select CAL CAL_ABORT PURGE	R/S
	:PLCOUTlink	:16 :4 :17 :5 :22 :11	Configuration of the PLC outputs OPEN CLOSE TRIGGER SEARCH ERROR WARNING READY STANDBY CAL_air ZERO_active WAIT PURGE_V1 PURGE_V2	R/S
	:RECMODE		recorder (LIN, LOG)	R/S
	:RECGAS		recorder gas (AUTO, 1, 2, 3, 4)	R/S
	:RS232		mode of RS232 interface (Diagnostics, ASCII, PRTAuto, PRTManu)	R/S

Table 11: List of commands, ASCII (cont.)

Command word1	Command word2	Command word3	Statement	Read/Set
	:SElect		gas select (Auto, Manu, Hold)	R/S
	:SELTime		Gas select time (5, 10, 15, 20)	R/S
	:SENSitivity		sensitivity check (ON, OFF)	R/S
	:SNIFFer		Audio sniffer (off, TRIGger SEARch) (for compatibility TRIGger ↔ on)	R/S
	:SPEAker		audio speaker internal (ON, OFF)	R/S
	:UNIT		pressure unit (Torr, mbar, atm, Pa)	R/S
	:VOLMin		minimum volume (0 ... 15)	R/S
	:VOLume		volume (0 ... 15)	R/S
	:WAKEup	:1 ... :7 :MON, :TUE...	WakeUp (hh:mm, 00:00 → disable) 1-Monday, 2-Tuesday, ...	R/S
	:WARNreminder		warning reminder (ON, OFF)	R/S
	:ZERO		ZERO (ON, OFF) sniffer line and main unit affected	
	:ZEROSniff		ZERO sniffer line (ON, OFF)	R/S
	:ZEROMain		ZERO via main unit (ON, OFF)	R/S
	:ZEROTime		ZERO time (1.0 ... 9.9)	R/S
*GAS:<no>	1 ... 4		gas number (1 ... 4)	
		:CALFAC	calibration factor	R
		:CALintern	Internal calibration enable: on, 1, ENable disable: off, 0, DISable (depends on selected mass)	R/S
		:CONFig	Configuration selected mass position 1, 2, ... 5 (depends on masses and factor)	R/S
		:CORRfac	Correction factor (The correction factor is calculated from the other settings)	R
		:EQUIname	Equivalent gas name (Equivalent gas only possible, if He/H2 mass 2/4 is selected. If an equivalent gas name is set, the viscosity is loaded from the RomLib.	R/S
		:FACTOR	Factor to the mass positions (5) (example: 0.72, 0.46, 0.12, 0.0, .0.)	R
		:GASpress	Equivalent gas pressure [bar]	R/S
		:HEpress	Pressure (He / H2) [bar]	R/S
		:LASTcal	last calibration (Date, Time, Internal / External)	R
		:LIMIT	Lower display limit (1, 2, 5, 10, 20, 50, 100)	
		:LRLimit	Lower display limit (leak rate)	R
		:MASS	mass position [amu] ± deviation [amu]	R
		:MASSES	possible mass positions (5) (example: 69, 83, 51, 0, 0) (R600a IGS on position 5) Notice: Changing this setting will clear the calibration data!	R/S

Table 11: List of commands, ASCII (cont.)

Command word1	Command word2	Command word3	Statement	Read/Set
		:MODE	Mode enable: on, 1, ENable disable: off, 0, DISable	R/S
		:NAME	Gas name (e.g. R134a)	R/S
		:PERcent	Concentration [%]	R/S
		:SEARch	search level (5 ... 100) [%]	R/S
		:TLRate	Leakrate external leak (4.1. [TLUnit]) (proper setting of molecular mass required)	R/S
		:TLUnit	Unit external leak (g/a, oz/yr, ppm, mbar*l/s, Pa*m3/s, atm*cc/s, Torr*l/s)	R/S
		:TRigger	Trigger level (2.5 [Unit])	R/S
		:UNIT	Trigger unit (g/a, oz/yr, ppm, mbar*l/s, Pa*m3/s, atm*ccs, Torr*l/s)	
*IDN			identification	R
	:DEVice		device name (E3000, ...)	R
	:IDENTnr		Test object ident number	R/S
	:SERial		serial number of Ecotec E3000	R
	:SNSerial		Sniffer Serial number	R
	:SNTyPe		Sniffer Type (length)	R
	:SNVersion		software version sniffer	R
	:TLSerial		serial number ECO-Check test leak block	R
	:TLSerial2		serial number ECO-Check gas reservoir	R
	:TLVersion		software version ECO-Check test leak	R
	:TCName		name of the turbo pump controller	R
	:VERsion		Software version of Ecotec E3000	R
*HOUR				
	:DATE		Date [dd.mm.yyyy] (set dd, mm, yyyy)	R/S
	:DEVICE		operating hours main unit [h]	R
	:POWer		time since power on [min]	R
	:RUNup		running-up time [s]	R
	:SERVice			R
		:TURBO	service turbo pump in [h]	R
		:FORE	service diaphragm pump in [h]	R
		:AIRfilter	service air filter in [h]	R
		:FILTER	service sniffer tip filter in [h]	R
	:TIME		Time [hh:mm:ss] [hh:mm] (set hh, mm)	R/S
	:TL	:DATE	Manufacturing date [dd.mm.yyyy] ECO-Check	R
		:EXPIry	Expiration date [dd.mm.yyyy] ECO-Check	R
		:WARntime	warning time to expiry date (14, 30, 60, 90 days)	R/S
	:TSP	:POWer	Transpector power on [h]	R
		:FILA	Transpector filament A [h]	R
		:FILB	Transpector filament B [h]	R

Table 11: List of commands, ASCII (cont.)

Command word1	Command word2	Command word3	Statement	Read/Set
	:TURBO		operating hours turbo pump [h]	R
*MEASure				R
	:Argon			R
		:Current	current for Argon [A]	R
		:Position	mass position for Argon [amu]	R
	:FLOW		actual flow [scm]	R
	:GLOBal		I-Guide trigger level of global leak rate exceeded (Gas A / B → 2 values)	R
	:POInt no		I-Guide measuring value [in selected unit] for measuring point no (1, 2, ...) (Gas A / B → 2 values)	R
		[TIMEstamp <no>]	with date and time (Gas A / B → 2 values)	R
	:Pressure			R
		:FOREline	foreline pressure [in selected unit of measurement]	R
		:TOTal	total pressure (Transpector) [Torr]	R
	:TEMPeratur			R
		:Electronic	electronics temp. [°C]	R
		:Leak	ECO-Check temp. [°C]	R
		:Tsp	Transpector temp. [°C]	R
		:TspMIN	Transpector temp. minimum [°C]	R
		:TspMAX	Transpector temp. maximum [°C]	R
		:TCElectronic	temperature of the turbo controller electronic	R
		:TCBearing	temperature of the turbo pump bearings	R
		:TCMotor	temperature of the turbo pump motor	R
		:TCPump	temperature of the turbo pump	R
	:TURBO			R
		:Current	current of TMP [A]	R
		:Frequency	frequency of TMP [Hz]	R
		:Power	power of TMP [W]	R
		:Voltage	voltage of TMP [V]	R
*PROGram			I-Guide	
	:1 :2 ... :10		use of I-Guide: Program number without a number the current program is used	-
		:ENABle	enable (ON, OFF) (will be added to list of selectable program when ON)	R/S
		:GAS :GASA	Gas name (A) (read only, determined by gas number)	R
		:GASB	Gas name B (read only, determined by Gas num B)	R
		:MEAStime	Measuring time [s] (1.0, 1.1, ... 25.0)	R/S

Table 11: List of commands, ASCII (cont.)

Command word1	Command word2	Command word3	Statement	Read/Set
		:NAME	name (max. 6 characters)	R/S
		:NR :NRA	gas number (1 ... 4)	R/S
		:NRB	Gas number B (1 ... 4)	R/S
		:POInts	Number of points (0, 1, ... 20)	R/S
		:TRIGger :TRIGA	Global trigger A [in selected unit] (unit read only, determined by gas number)	R/S
		:TRIGB :TRIGgerB	Global trigger gas B [selected unit] (unit read only, determined by gas number B)	R/S
		:WAITtime	Wait time [s] (1.0, 1.1, ... 25.0)	R/S
	:ABORT		Restarting testing cycle	S
	:BACK		Point back	S
	:BUTTon		use of I-Guide button (right probe button) (ON, OFF)	R/S
	:CONFirm		Confirm point	S
	:CYCLE		Cycle counter (for resetting set counter to 0)	R/S
*READ			Leak rate (first selected gas) [selected unit]	R
	[1] [2] [3] [4]		Leak rate gas 1 Leak rate gas 2 Leak rate gas 3 Leak rate gas 4 without gas number the first selected gas is given	
		[g/a] [oz/yr] [ppm] [mbar*l/s] [Pa*m3/s] [atm*cc/s] [Torr*l/s]	Leak rate in [g/a] Leak rate in [oz/yr] Leak rate in [ppm] Leak rate in [mbar*l/s] Leak rate in [Pa*m3/s] Leak rate in [atm*cc/s] Leak rate in [Torr*l/s] (without unit the selected unit is used)	R
*SLEEP			stop, go to SLEEP	S
*STANdby			StandBy mode (no display)	S
*START			start measurement mode (after SLEEP or STANDBY)	S
*STATus			status of the Ecotec E3000 INIT (initialisation), ACCL (acceleration), MEAS (measuring), CALEXT (calibration external), CALINT (calibration internal), PROOF, ERROR, SLEEP, PURGE, STANDBY	R

Table 11: List of commands, ASCII (cont.)

Command word1	Command word2	Command word3	Statement	Read/Set
	[:CAL]		status calibration (status number) 2 - LEAKRATE STABLE, CONFIRM 4 - BASELINE 7 - AIR STABLE, CONFIRM 9 - PEAKFIND ARGON 10 - CAL FINISHED, CONFIRM 14 - PEAKFIND M84 15 - PEAKFIND M69 16 - MEASURE M69 /83 17 - REMOVE SNIFFER	R
	[:CALHist 1] [:CALHist 1] ... [:CALHist 12]		Calibration history part1 starting from 1 to 12 Date, time, cal.-type (internal/external gas nr.), mass position, calibration factor)	R
	[:CALHist2 1] [:CALHist2 1] ... [:CALHist2 12]		Calibration history part 2 starting from 1 to 12 Operating hours, filament, flow, argon current, argon position	R
	[:CALHist3 1] [:CALHist3 2] ... [:CALHist3 12]		Calibration history part 3 starting from 1 to 12 factor, position 1, position 2, gas number/mass	R
	[:CALHist 4 1] [:CALHist4 2] ... [:CALHist4 12]		Calibration history part 4 starting from 1 to 12 leak rate test leak, Unit test leak, current test leak, current background	
	[:CALMode]		type of calibration (NO, PROOF, INTERNAL, EXTERNAL)	R
	[:ERRor]		Current error number (NO ERROR / WARNING, ERROR <no>, WARNING <no>)	R
	[:ERRorHist 1] [:ERRorHist 2] ... [:ERRorHist 12]		Error history starting from 1 to 12 Date, Time, Error number	R
	[:INput]		State PLC input Byte 1 Pin 7 Sleep Byte 2 Pin 20 Zero Byte 3 Pin 9 Gas a Byte 4 Pin 25 Gas select Byte 5 Pin 13 Gas b Byte 6 Pin 8 Purge	R
	[:OUTput]		State PLC output Byte 1 Pin 16 Trigger Byte 2 Pin 4 Ready (V1) Byte 3 Pin 17 Error Byte 4 Pin 5 reserve (V2) Byte 5 Pin 24/12/11 Ready (Relais) Byte 6 Pin 10/23/22 Trigger (Relais)	R

Table 11: List of commands, ASCII (cont.)

Command word1	Command word2	Command word3	Statement	Read/Set
	[:SNkey]		State Sniffer key Byte 1 left Byte 2 right	R
	[:LEAK]		ECO-Check test leak	R
		[:Gas]	gas type (e.g. R134a)	R
		[:GAIN]	compensation gain	R
		[:LREff]	effective leak rate in [g/a]	R
		[:LRNom]	nominal leak rate in [g/a]	R
		[:Offset]	compensation offset	R
		[Unit]	Leak rate unit	
	[:PROGram]	[:POInt]	I-Guide: current measuring point (number, not measured yet, 0-end)	R
		[:CYCLe]	State I-Guide cycle MOVE - "Move to point x" WAIT - "Please wait" CHECK - "Leak check point x" END - Display result of cycle CONFIRM - "Confirm point x" (UNKNOWN - intermediate state)	R
		[:GLOBal]	Global leak rate exceeded	R
		[:SINGle]	Single leak rate exceeded	R
	[:PROof]		status of proof function (status number) 2 - WAIT UNTIL STABLE 7 - WAIT UNTIL AIR STABLE 10 - SHOW RESULTS 16 - MEASURE LEAK 17 - REMOVE UNTIL AIR STABLE	R
	[:SEARCh] [:SEARCh 1] [:SEARCh 2] [:SEARCh 3] [:SEARCh 4]		Search level of gas x exceeded DISABLED, OFF, ON (without number "ON" is read if any gas exceeds the search level)	R
	[:SElect]		Pointer to currently highest leak rate	R
		[:Gas]	Gas no. (gas displayed on the probe display)	R
		[:LR]	Leak rate (in selected unit)	R
		[:NAME]	Gas name	R
		[:TRIGger]	Gas no. of gas exceeding trigger 0 - if no gas exceeds the trigger	R
	[:SERviceHist 1] [:SERviceHist 2] ... [:SERviceHist 12]		Service history starting from 1 to 12 Date, time, operating hours, Type of maintenance, CUSTOMER/SERVICE	R
	[:TRIGger] [:TRIGger 1] ... [:TRIGger 4]		Trigger level of gas x exceeded DISABLED, OFF, ON (without number "ON" is read if any gas exceeds the trigger level)	R

Table 11: List of commands, ASCII (cont.)

Command word1	Command word2	Command word3	Statement	Read/Set
	[:WARNing]		State warning flags Byte 1 – Capillary Byte 2 – CalRequest Byte 3 – TICommunication Byte 4 – SnCommunication Byte 5 – ServiceMessage Byte 6 – Service Filter Byte 7 – Voltages Byte 8 – TlExpired Byte 9 – Factor K1 Byte 10 – Flow changed Byte 11 – TlNearlyExpired Byte 12 – TlNew Byte 13 – LightBarrier	R
	[:ZERO]		zero (on / off)	R
*USER				
	:1 :2 :3 :4 :5 :6		Gas number	
		:NAME	Name (example: R236fa; max. 6 characters)	R/S
		:MASS	Mass position [amu]	R/S
		:NORMfac	Normalization factor	R/S
		:MOLmass	Molecule mass (example: 102.0)	R/S
*ZERO			ZERO (update or enabling)	S
	[:OFF]		ZERO off (ZERO)	S

3.2.3 Error Messages

The following error messages may be received from the Ecotec E3000:

Table 12: Error messages

Error number	Error message	Statement
OK	ERR_OK	Command ausgeführt
E01	ERR_CMD_START	wrong command start (no "*")
E02	ERR_BLANK	illegal blank
E03	ERR_CMD_WORD_1	Command Word 1 illegal
E04	ERR_CMD_WORD_2	Command Word 2 illegal
E05	ERR_CMD_WORD_3	Command Word 3 illegal
E06	ERR_DISABLED	control via RS232 not enabled
E07	ERR_ARGUMENT	argument wrong
E08	ERR_NO_DATA	no data available
E09	ERR_OVERFLOW	buffer overflow
E10	ERR_INVALID	Command currently invalid
E11	ERR_NO_QUERY	no query allowed
E12	ERR_QUERY	only query allowed
E13	ERR_NOT_IMPLEMENTED	not yet implemented

3.3 Interfaces settings at the Ecotec E3000

At "Settings > Interfaces" you make the settings for the interfaces.

3.3.1 Control location

- Local
- RS-232
- Local and RS-232

Local: In this mode the RS-232 interface can only be used to read data, but not for control purposes.

RS-232: In this mode the Ecotec E3000 is controlled solely via the interface and the display can only be used for viewing data. Even with the control location set to RS-232 some parameter may still be able to be changed through the main units software menus. Please lock these by the menu PIN to prevent unintended changes.

Local and RS-232: In this mode the Ecotec E3000 can be controlled via the interface but also by input from the main display.

Default setting: Local and RS-232

3.3.2 RS-232 Protocol

The RS-232 protocol can be set to "ASCII", "Diagnostics", "Printer auto" or "Printer manual".

ASCII

The ASCII protocol is a protocol similar to the SCPI, a standard protocol widely used for measuring equipment.

Diagnostics

The diagnostics protocol is a binary protocol used for analysis in quality control and trouble shooting during manufacturing and service.

Default setting: ASCII

Printer manual

The Printer manual protocol allows to send leak rates on pressing the right sniffer probe button. One line will be send for each currently enabled gas.

When in any of the two printer modes, no ASCII commands must be sent to the Ecotec E3000 as this will interrupt the printer mode.

Format				
Date	Time	Gas name	Leak rate	Unit
Example				
03.05.2005	12:31	R134a	2.34	g/a
03.05.2005	12:31	R600a	<0.1	g/a

When set to I-Guide mode the Printer manual mode is without function.

Printer auto

In "Printer Auto" the leak rate will be sent any time the set trigger level is exceeded. At the time the signal drops below the trigger level the maximum detected leak rate will be sent only for the gas(es) that exceeded the trigger.

Format				
Date	Time	Gas name	Leak rate	Unit
Example				
03.05.2005	12:31	R134a	2.34	g/a

When set to I-Guide mode the leak rate results will be sent after each test point together with the test point number.

After the test cycle has been completed, the summarized global leak rate will be sent.

Example:

Point no.	Date	Time	Leak rate	Unit
Point 01			0.1	g/a
Point 02			0.1	g/a
Point 03			12.2	g/a
Point 04			0.1	g/a
Global	13.04.2007	11:57:03	12.5	g/a

3.3.3 Interface Parameters: Baud rate & end sign

In the ASCII mode the baud rate and the end sign can be selected.

The baud rate can be set to the values 1200, 2400, 4800, 9600 or 19200.

Default setting: 9600.

The end sign can be set to Carriage Return (CR), Line Feed (LF) or to CR+LF.

Default setting: CR+LF.

3.4 Examples of programming

3.4.1 Operating in measurement mode

Gas settings:

- Gas 1: R134a, unit g/a
- Gas 2: disabled
- Gas 3: disabled
- Gas 4: He, unit mbar*/l/s

RS-232 Interface settings:

- RS-232 protocol: ASCII
- Baud rate & End sign: 19200 / CR (must be identical with settings of PC)
- Control location: Local and RS-232 (if RS-232 is not enabled, control through the interface is impossible)

With these commands the status of the Ecotec E3000, the status of the trigger and the leak rates can be monitored in measurement mode.

Table 13: Commands and responses measurement mode

Command sent to Ecotec E3000	Response received from Ecotec E3000	Meaning
.....		
*status? (CR)		Requests the status of the Ecotec E3000.
	MEAS (CR)	Ecotec E3000 is in measurement mode.
*status:trigger? (CR)		Requests the status of the trigger for all enabled gases.
	OFF (CR) ON (CR)	Both leak rates are below trigger value. One or both leak rates exceed the trigger value.
*read 1? (CR)		Requests the leak rate for gas number 1 (R134a).
	3.9 g/a (CR)	Leak rate Gas 1 (R134a)
*read 4? (CR)		Requests the leak rate for gas number 4 (He).
	2.5E-5 mbar*/l/s (CR)	Leak rate Gas 4 (He)
.....		
If an error occurs, the status changes from MEAS to ERROR, the error number can be queried and no leak rates will be available anymore. If the problem has been fixed the error can be acknowledged and the unit will start up again and go back into measurement mode.		
*status? (CR)		Requests the status of the Ecotec E3000.
	ERROR (CR)	Ecotec E3000 currently shows an error.
*status:error? (CR)		Requests the error number the Ecotec E3000 currently shows.
	ERROR 47 (CR)	Error number 47 (Transpector over pressure!)
*read 1? (CR)		Requests the leak rate for gas number 1 (R134a).
	E08 (CR)	ERR_NO_DATA, no data available as unit currently shows an error.
....		
*cls (CR)		Acknowledges (clears) the error message.
	OK (CR)	Ecotec E3000 has received request okay, unit will start up again.
*status? (CR)		Requests the status of the Ecotec E3000.
	ACCL (CR)	Ecotec E3000 is starting up.

Table 13: Commands and responses measurement mode (cont.)

Command sent to Ecotec E3000	Response received from Ecotec E3000	Meaning
*status? (CR)		Requests the status of the Ecotec E3000.
	MEAS (CR)	Ecotec E3000 is in measurement mode.

3.4.2 Performing an external calibration

Gas settings and interface settings as above.

With the following chain of command an external calibration of gas 1 (R134a) may be controlled via RS-232. The progress of the calibration is shown on the main unit display, any confirmations through the buttons of the main unit display nor the probe button is impossible however.

Table 14: Commands and responses external calibration

Command sent to Ecotec E3000	Response received from Ecotec E3000	Meaning
.....		
*status? (CR)		Requests the status of the Ecotec E3000.
	MEAS (CR)	Ecotec E3000 is in measurement mode.
*cal:start (CR)		Starts calibration process.
	OK (CR)	Ecotec E3000 has received start signal.
*cal:status? (CR)		Requests the status of the calibration.
	T<20 MIN, CONFIRM (CR)	If the Ecotec E3000 has been running for less than 20 min a warning is sent by the Ecotec E3000 .
*cal:quit (CR)		Acknowledges warning
	OK (CR)	Ecotec E3000 has received acknowledgement.
*cal:status? (CR)		Requests the status of the calibration.
	SELECT GAS (CR)	Status is: gas to be calibrated must be selected.
*cal:select 1 (CR)		Selects gas 1 (R134a) for external calibration.
	OK (CR)	Ecotec E3000 has received selection.
*cal:status? (CR)		Requests the status of the calibration.
	START CAL, CONFIRM (CR)	Status is: ready for calibration.
If test leak rate setting and unit of test leak is known from last calibration process and identical, the calibration may be started immediately (see next table), otherwise the test leak information has to be sent to the Ecotec E3000 first:		
*cal:unit? (CR)		Requests the set unit of the test leak rate.
	g/a (CR)	Unit of test leak rate is g/a.
*cal:leakrate? (CR)		Requests the currently set leak rate for the external test leak.
	10.4 (CR)	Leak rate is 10.4 (g/a).
*cal:leakrate 4.1 (CR)		Sets the leak rate of the external test leak used to 4.1 (g/a).
	OK (CR)	Ecotec E3000 has received new setting.
*cal:status? (CR)		Requests the status of the calibration.
	START CAL, CONFIRM (CR)	Status is: ready for calibration.
Calibration may now be started:		
*cal:quit (CR)		Starts the calibration process.
	OK (CR)	Ecotec E3000 has received start signal.

Table 14: Commands and responses external calibration (cont.)

Command sent to Ecotec E3000	Response received from Ecotec E3000	Meaning
*cal:status? (CR)		Requests the status of the calibration.
	LEAK STABLE, CONFIRM (CR)	Status: waiting for acknowledgement that signal from test leak is stable.
*cal:read? (CR)		Requests leak rate signal reading.
	8.2638e-14 (CR)	Signal from test leak is 8.2638e-14.
.....	<i>This request should be repeated several times to determine whether the reading has stabilized.</i>	
*cal:quit (CR)		Starts the test leak measurement.
	OK (CR)	Ecotec E3000 has received start signal.
*cal:status? (CR)		Requests the status of the calibration.
	WAIT (CR)	Status: measuring test leak
.....		
*cal:status? (CR)		Requests the status of the calibration.
	AIR STABLE, CONFIRM (CR)	Status: waiting for background measurement, waiting for signal to be confirmed to be stable.
*cal:read? (CR)		Requests leak rate signal reading.
	3.0513e-15 (CR)	Signal from background is 3.0513e-15.
.....	<i>This request should be repeated several times to determine whether the reading has stabilized.</i>	
*cal:quit (CR)		Starts the background measurement.
	OK (CR)	Ecotec E3000s has received start signal.
*cal:status? (CR)		Requests the status of the calibration.
	WAIT (CR)	Status: measuring background
.....		
*cal:status? (CR)		Requests the status of the calibration.
	CAL FINISHED, CONFIRM (CR)	Status: calibration finished without errors, results are available.
*cal:factor:old? (CR)		Requests data for old calibration factor.
	1.95 (CR)	Old calibration factor was 1.95.
*cal:factor:new? (CR)		Requests data for new calibration factor.
	2.05 (CR)	new calibration factor is 2.05.
*cal:pos:old? (CR)		Requests data for old mass position deviation.
	0.05 (CR)	Old mass position deviation was 0.05.
*cal:pos:new? (CR)		Requests data for new mass position deviation.
	0.10 (CR)	New mass position deviation is 0.10.
*cal:flow:old? (CR)		Requests data for old flow at calibration.
	176 (CR)	Old flow was 176 (sccm).
*cal:flow:new? (CR)		Requests data for new flow at calibration.
	187 (CR)	New flow is 187 (sccm).
*cal:quit (CR)		Save results of new calibration.
	OK (CR)	Ecotec E3000 has received request to save new values.
*cal:status? (CR)		Requests the status of the calibration.
	WAIT (CR)	Status: wait, data is being saved, new offset is determined.
*status? (CR)		Requests the status of the Ecotec E3000.

Table 14: Commands and responses external calibration (cont.)

Command sent to Ecotec E3000	Response received from Ecotec E3000	Meaning
	CAL (CR)	Status: still in calibration mode (calibration process not finished yet).
.....		
*status? (CR)		Requests the status of the Ecotec E3000.
	MEAS (CR)	Ecotec E3000 is in measurement mode.
The calibration process may be cancelled at any time with <code>**cal:esc (CR)</code> . If an error occurs during the calibration process (e.g. "ERR78, CONFIRM"), the error message may be acknowledged with <code>*cal:quit (CR)</code> .		

4 Trouble Shooting

Table 15: Trouble Shooting

Error	Possible Reason	Solution
No characters are received via the interface/the Ecotec E3000 does not answer.	Wrong cable	Please use a 1:1 cable, (NO null-modem cable, also called cross-over cable!).
	Problems with flow control	Deactivate flow control in PC/PLC or use cable according to the wiring diagram in Section 2.
	Wrong COM-Port used at PC.	Select correct COM-Port.
	Wrong interface parameters (Baud rate, Data bits, Parity, Stop bits)	Check if interface parameters (Baud rate, number of data bits, parity bit and number of stop bits in the Ecotec E3000 and PC / PLC match).
	Wrong protocol selected in the Ecotec E3000.	Select correct protocol in the Ecotec E3000.
	PC uses an USB-RS-232 converter.	In general the Ecotec E3000 will also work with an USB-RS-232-converter. However, these often cause multiple difficult to track problems (driver, flow control.) Please test your PC program on a "real" RS-232 interface first preferably. Especially with USB-RS-232-converters it is often helpful to use a cable according to the wiring diagram in Section 2.
	Serial interface of PC is (still) occupied with a different program .	Check if other programs (e.g. a synchronisation software for your hand-held computer) uses the serial interface. It is also possible that an already closed program has not released the interface again yet. In this case a restart of the PC will help.
The Ecotec E3000 replies with "unreadable" characters.	Wrong interface parameters (Baud rate, Data bits, Parity, Stop bits).	Check if interface parameters (Baud rate, number of data bits, parity bit and number of stop bits in the Ecotec E3000 and PC / PLC match).
	Wrong protocol selected in the Ecotec E3000.	Select correct protocol in the Ecotec E3000.
Ecotec E3000 does not reply / Ecotec E3000 replies after several command with "E10"	"Carriage Return" at the end of the command is missing.	Finish all commands with "Carriage Return" (ASCII 0dhex / 13dez).
Ecotec E3000 replies with "E06".	Control via RS-232 not enabled in the Ecotec E3000.	Enable control via RS-232 (see submenu CONTROL LOCATION).
Ecotec E3000 replies with error message to the first command only, following commands are interpreted correctly.	Receiving buffer of the Ecotec E3000 was not empty before sending the first command (e.g. by plugging in the RS-232 cable during operation)	In the ASCII protocol the Ecotec E3000 has not time out function which will empty the receiving buffer automatically. Therefore, the buffer should be emptied before the first command by sending of "ESC", "^C" or "^X".



INFICON GmbH, Bonner Strasse 498, D-50968 Cologne, Germany
Phone: +49 (0)221 347-40 Fax: +49 (0)221 347-41429 E-mail: leakdetection@inficon.com

UNITED STATES TAIWAN JAPAN KOREA SINGAPORE GERMANY FRANCE UNITED KINGDOM HONG KONG
Visit our website for contact information and other sales offices worldwide. www.inficon.com

Dokument: kins22e1-j 1401