

TYPE EVD-6

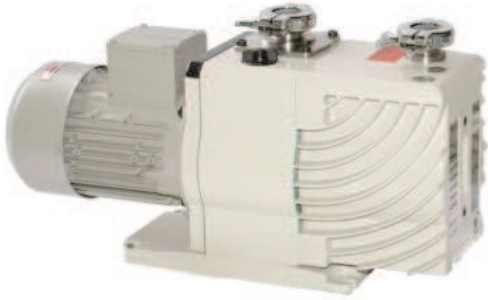

Pumping speed curve

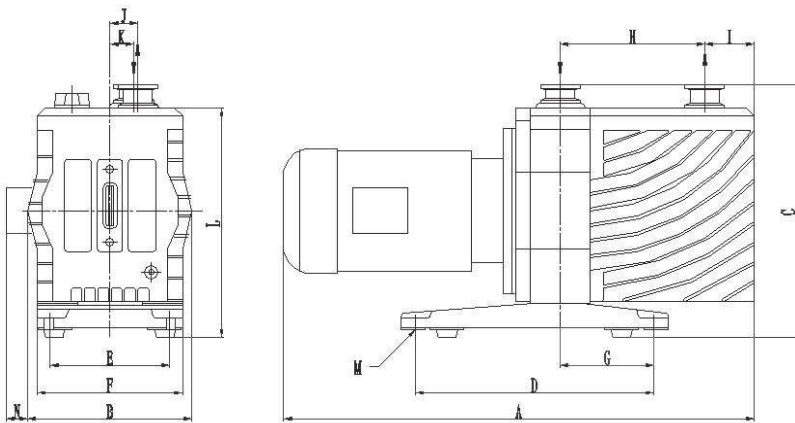
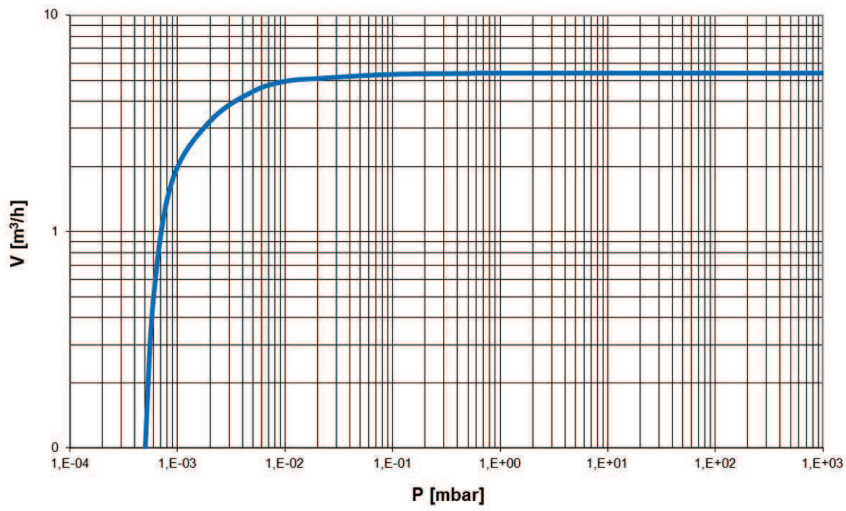

Dimensions	A	B	C	D	E	F	G	H	I	J	K	L	M	N
EVD-6	470	165	252	240	120	146	94	120	50	24	28	229	Ø9	53

TYPE EVD-6

Technical Data		TYPE EVD-6	
		50 Hz	60 Hz
Nominal displacement	m ³ /h	5,4	6,5
Ultimate partial pressure	mbar	10 ⁻⁴	10 ⁻⁴
Ultimate total pressure	mbar	4x10 ⁻³	4x10 ⁻³
Motor power	kW	0,37	0,37
Nominal speed	rpm	1450	1750
Water vapor tolerance	mbar	50	50
Noise level	dB	50	52
Oil capacity	ltr	1,3	1,3
Weight	kg	23	23
Admissible ambient temp.	°C	10 to 40	10 to 40
Connection	Inlet	DIN 25 KF	25 KF
	Outlet	DIN 25 KF	25 KF

Ordering Information	TYPE EVD-6
Single phase motor 230V, 50/60Hz	420901
110-115V, 50/60Hz	420903
Three phase motor 400V, 50Hz / 460V, 60Hz	420902
Other Voltages/Frequencies	Upon request
Filling with special oil	Upon request
Exhaust oil mist filter EF-25A	420910A
Replacement cartridge for EF-25A	420916A
Seal kit	420911
Overhaul kit	420912
Inlet dust filter, polyester cartridge	778025
Inlet dust filter, Activated Alumina	778026
EV-Highvacuum Oil-60	
1 ltr can	100400
5 ltr can	100402
20 ltr can	100403