

Vacuum Control Catalog 2018–2020

Vacuum Gauges, Fittings and Feedthroughs





Gauge Selection Overview

Capacitance Diaphragm Gauge

CDG: gas type independent, high accuracy corrosion resistant

Sensor Temperature [°C]	Accuracy [%]	Characteristics	Setpoints	Full scales [Torr] ...		
				10m	100m	1
Ambient	0.5	Compact Gauge	w/o			
	1					
Ambient	0.2	Standard Gauge	w/o		0.1 - 100m	0.0005 - 1
			2			
		Process Gauge	2		0.1 - 100m	0.0005 - 1
			w/o		0.1 - 100m	0.0005 - 1
Ambient	0.2	EtherCAT	2			0.0005 - 1
45	0.15	Process Gauge	2		0.1 - 100m	0.0005 - 1
		Compact Gauge, EtherCAT				0.0005 - 1
		Fast Process Gauge		0.01 - 10m	0.1 - 100m	0.0005 - 1
45	0.025	Reference Gauge	w/o		0.1 - 100m	0.0005 - 1
100	0.2	Process Gauge	2		0.1 - 100m	0.0005 - 1
		Compact Gauge, EtherCAT				0.0005 - 1
		Fast Process Gauge			0.1 - 100m	0.0005 - 1
160	0.4	Process Gauge	2			0.0005 - 1
200	0.4	Process Gauge	2			0.0005 - 1
Ambient	0.4	OEM Integration	2			

Please select part number, flange, connector, filter, field bus, etc in ordering information on website or datasheet.

...Full scales [Torr]			Product	Type	Page
10	100	1000			
0.01 - 10	0.1 - 100	1 - 1000	CDG020D	Porter™	A1
0.01 - 10	0.1 - 100	1 - 1000	CDG025D	SKY™	A5
			CDG025D-S		
0.01 - 10	0.1 - 100	1 - 1000	CDG025D-X3	SKY™	A9
0.01 - 10	0.1 - 100	1 - 1000	CDG025D-X3	SKY™	A13
0.01 - 10	0.1 - 100	1 - 1000	CDG025D2	Edge™	A17
0.01 - 10	0.1 - 100	1 - 1000	CDG045D	SKY™	A21
0.01 - 10	0.1 - 100	1 - 1000	CDG045D2	Edge™	A27
0.01 - 10	0.1 - 100	1 - 1000	CDG045Dhs	Stripe™	A31
0.01 - 10	0.1 - 100	1 - 1000	CDGsci	Cube™	A35
0.01 - 10	0.1 - 100	1 - 1000	CDG100D	SKY™	A39
0.01 - 10	0.1 - 100	1 - 1000	CDG100D2	Edge™	A45
0.01 - 10	0.1 - 100	1 - 1000	CDG100Dhs	Stripe™	A49
0.01 - 10	0.1 - 100	1 - 1000	CDG160D	SKY™	A53
0.01 - 10	0.1 - 100	1 - 1000	CDG200D	SKY™	A53
0.01 - 10	0.1 - 100	1 - 1000	CDS500D	Spot™	on request

Active Gauge Selection Overview

Measurement principles:

- Hot Ion
- Cold Cathode
- Pirani
- Capacitance Diaphragm

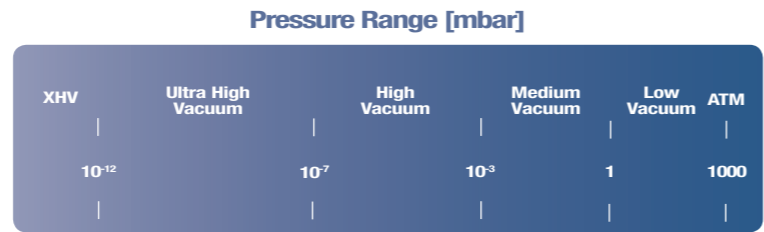

Applications	XHV	Ultra High Vacuum	High Vacuum	Medium Vacuum	Low Vacuum	ATM
<ul style="list-style-type: none"> Fore vacuum pressure monitoring Safety circuits in vacuum systems General vacuum measurement and control from atmosphere to the medium vacuum range 						
<ul style="list-style-type: none"> Load lock control Fore vacuum pressure monitoring Safety circuits in vacuum systems General vacuum measurement and control from atmosphere to the medium vacuum range 						
<ul style="list-style-type: none"> General vacuum measurement and control in the medium to the low vacuum range Fore vacuum pressure monitoring 						
<ul style="list-style-type: none"> Pressure measurement in semiconductor process and transfer chambers Industrial coating General vacuum measurement and control from atmosphere to the ultra high vacuum range 						
<ul style="list-style-type: none"> Pressure measurement in Semiconductor process, transfer and loadlock chambers Industrial coating General vacuum measurement and control from atmosphere to the ultra high vacuum range 						
<ul style="list-style-type: none"> Sputter applications in Semiconductor manufacturing, electronics and media industry Industrial coating General vacuum measurement and control in medium to the high vacuum range 						
<ul style="list-style-type: none"> Base pressure monitoring and control, from atmosphere to high vacuum in evaporation and sputter coating applications General vacuum measurement - industrial furnaces, architectural glass, semiconductor, refrigeration and air conditioning Analytical and R&D applications - mass spectrometry, electron microscopes, medial, ophthalmic, optical and high energy physics 						
<ul style="list-style-type: none"> General vacuum measurement and control in medium and high vacuum range High vacuum pressure monitoring Base pressure for evaporation and sputtering systems 						
<ul style="list-style-type: none"> General vacuum measurement and control in the high vacuum range High vacuum pressure monitoring Evaporation and sputtering systems 						

Corrosion resistant version	Setpoints	Display	Controller		Interfaces				Principle	Product	Page
			VGC50x	PGL500	RS232	RS485	DeviceNet	Profibus			
✓	2		✓	✓					Pirani	PSG500	A95
✓	2	✓	✓	✓	✓	✓	✓	✓	Pirani	PSG55x	A99
✓	2	✓	✓	✓	✓	✓	✓	✓	Pirani Capacitance	PCG55x	A105
	1	✓							Convection Enhanced Pirani	PGE300	A91
	2	✓			✓	✓			Convection Enhanced Pirani	PGE500	A87
	2	✓			✓	✓			Bayard-Alpert HotIon	BAG302	A63
									Bayard-Alpert HotIon	BAG402	A66
	2	✓	✓		✓		✓	✓	Bayard-Alpert Pirani	BPG40x	A69/A73
	2	✓	✓		✓		✓	✓	Bayard-Alpert HotIon Pirani Capacitance	BCG450	A82
	2	✓	✓		✓		✓	✓	Hot Ion Pirani	HPG400	A78
✓			✓		✓	✓		✓	Inverted Magnetron / Cold Cathode	MAG5xx	A114
✓			✓		✓	✓		✓	Inverted Magnetron Pirani / Cold Cathode	MPG5xx	
			✓	✓					Inverted Magnetron Pirani / Cold Cathode	MPG40x	A119
			✓				✓	✓	Penning / Cold Cathode	PEG100	A111

¹⁾ available July 2018

Passive Gauge Selection Overview

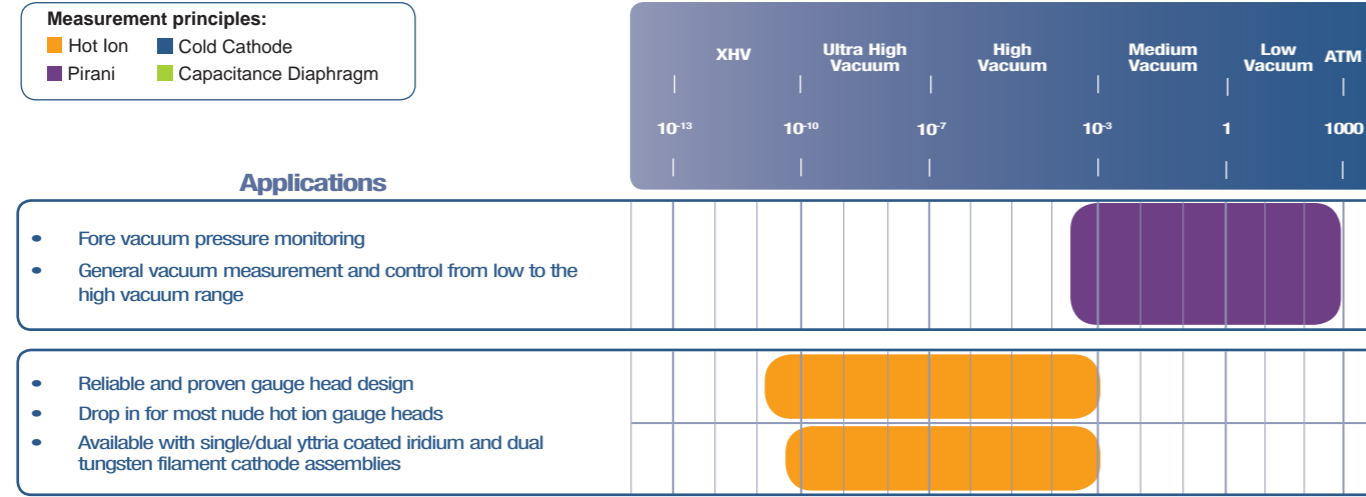

Corrosion resistant version	Setpoints	Display	Controller		Interfaces				Principle	Product	Page
			VGC001	VGC003	RS232	RS485	DeviceNet	Profibus			
			✓						Pirani	PGE050	A136
			✓	✓					Bayard-Alpert Hot Ion	BAG050	A141
			✓	✓					Bayard-Alpert Hot Ion	BAG051 BAG052 BAG053	

Table of Contents

Active & Passive Vacuum Gauges & Controller

Ambient capacitance diaphragm gauge

Porter™ CDG020D	A1
SKY® CDG025D	A5
SKY® CDG025D-X3 process gauge	A9
SKY® CDG025D-X3 4-20mA current loop	A13
Edge™ CDG025D2 with EtherCAT	A17

Heated capacitance diaphragm gauge

SKY® CDG045D, process gauge	A21
Edge™ CDG045D2, compact	A27
Stripe™ CDG045Dhs, high speed	A31
Cube™ CDGsci, reference	A35

SKY® CDG100D, process gauge	A39
Edge™ CDG100D2, compact	A45
Stripe™ CDG100Dhs, high speed	A49

SKY® CDG160D, CDG200D, process gauge	A53
VGD500	A59
Application specific CDG Solutions	A61

Bayard Alpert Gauge

BAG302	A63
BAG402	A66

Bayard-Alpert Pirani Gauge

BPG400	A69
BPG402-S	A73

High Pressure Hot Ionization Pirani Gauge

HPG400	A78
PGE500	A82
PGE300	A86

Bayard-Alpert Pirani Capacitance Diaphragm Gauge

TripleGauge® BCG450	A90
---------------------------	-----

Pirani Standard Gauge

PSG500/-S, PSG502-S, PSG510-S, PSG512-S	A95
PSG550, PSG552, PSG554	A99

Table of Contents (continued)

Pirani Capacitance Diaphragm Gauge	
PCG550, PCG552, PCG554.....	A105
Penning Gauge	
PEG100.....	A111
Inverted Magnetron/Inverted Magnetron Pirani Gauge	
NEW Gemini MAG500/504.....	A114
MPG400/401.....	A119
Vacuum Gauge Controllers	
VGC50x.....	A122
PGD400.....	A125
Vacuum Switch	
VSA100A.....	A127
VSA200, VSD200.....	A129
VSC150A.....	A133
Calibration Service	
Vacuum Gauges.....	A148
Inspection Documents Service	
Vacuum Control.....	A149
Passive Vacuum Gauges	
PGE050.....	A136
VGC031.....	A138
BAG050, BAG051, BAG052, BAG053.....	A141
VGC083A/VGC083B.....	A144
Calibration Service	
Vacuum Gauges.....	A148
Inspection Documents Service	
Vacuum Control.....	A149

Vacuum Feedthroughs

Rotary Feedthroughs ISO-KF / ISO-K	
FRH DN 16 - DN 63.....	B1
Rotary Feedthroughs CF	
FRU DN 16 - DN 40.....	B3
Rotary/Linear Motion Feedthroughs ISO-KF	
FCH DN 16 - DN 40.....	B5

Table of Contents (continued)

Linear Motion Feedthroughs CF

FPU DN 16 - DN 40	B7
-------------------------	----

Electrical Feedthroughs

DN 16 ISO-KF	B9
DN 40 ISO-KF	B11
DN 16 CF-F	B13
DN 40 CF-F	B15
DN 40 ISO-KF	B17

Coaxial Feedthroughs ISO-KF / CF-F

BNC / MHV DN 16 - 40	B19
----------------------------	-----

Vacuum Feedthroughs

Metal-Ceramic Connections	B21
---------------------------------	-----

Liquid Feedthroughs ISO-KF / CF-F

DN 40	B23
-------------	-----

Viewports

DN 16 - DN 50 ISO-KF	B25
DN 63 - DN 160 ISO-K	B27
DN 16 - DN 160 CF	B29
DN 63 - DN 160 ISO-F	B31

Vacuum Feedthroughs

Vacuum Ball Bearings	B33
Lubricants and Sealing Materials	B35

Inspection Documents Service

Vacuum Control	A149
----------------------	------

Vacuum Fittings

Specifications

Seals	C1
Pressure Range	C1

ISO-KF Small Flange Components

Connection Elements	C2
Seals	C6
Flanges	C14
Pipe Fittings	C16
Bellows / Hose with Flanges	C19
Transition Pieces	C21
Hose, Hose Connection	C25

Table of Contents (continued)

ISO-K Clamp Flange Components

Connection Elements	C28
Seals	C30
Flanges	C33
Pipe Fittings	C35
Bellows/Hose with Flanges	C38
Transition Pieces	C39
Protective Lids	C41

ISO-F Fixed Flange Components

Flange Components	C42
-------------------------	-----

UHV CF Components

Connection Elements	C45
Seals	C47
Flanges	C49
Pipe Fittings	C54
Bellows/Hose with Flanges, Compensator	C57
Transition Pieces	C58
Protective Lids	C59

Inspection Documents Service

Vacuum Control	A149
----------------------	------



Vacuum Gauges

Vacuum Gauges

Active Vacuum Gauges & Controllers

Ambient Capacitance Diaphragm Gauge

Porter™ CDG020D	A1
SKY® CDG025D	A5
SKY® CDG025D-X3 process gauge	A9
SKY® CDG025D-X3 4-20mA current loop	A13
Edge™ CDG025D2 with EtherCAT	A17

Heated Capacitance Diaphragm Gauge

SKY® CDG045D, process gauge	A21
Edge™ CDG045D2, compact	A27
Stripe™ CDG045Dhs, high speed	A31
Cube™ CDGsci, reference	A35
SKY® CDG100D, process gauge	A39
Edge™ CDG100D2, compact	A45
Stripe™ CDG100Dhs, high speed	A49
SKY® CDG160D, CDG200D, process gauge	A53
VGD500 pressure display	A59
Application specific CDG solutions	A61

Bayard-Alpert Gauge

BAG302	A63
BAG402	A66

Bayard-Alpert Pirani Gauge

BPG400	A69
BPG402-S	A73

High Pressure Hot Ionization Pirani Gauge

HPG400	A78
PGE500	A82
PGE300	A86

Bayard-Alpert Pirani Capacitance Diaphragm Gauge

TripleGauge® BCG450	A90
---------------------------	-----

Pirani Standard Gauge

PSG500/-S, PSG502-S, PSG510-S, PSG512-S	A95
PSG550, PSG552, PSG554	A99

Vacuum Gauges (continued)

Pirani Capacitance Diaphragm Gauge

PCG550, PCG552, PCG554. A105

Penning Gauge

PEG100 A111

Inverted Magnetron/Inverted Magnetron Pirani Gauge

NEW Gemini MAG500/504, MPG500/504 A114

MPG400/401 A119

Vacuum Gauge Controllers

VGC50x A122

PGD500 A125

Vacuum Switch

VSA100A. A127

VSA200, VSD200 A129

VSC150A A133

Calibration Service

Vacuum Gauges A148

Inspection Documents Service

Vacuum Control A149

Passive Vacuum Gauges & Controllers

PGE050 A136

VGC031 A138

BAG050, BAG051, BAG052, BAG053 A141

VGC083A/VGC083B. A144

Calibration Service

Vacuum Gauges A148

Inspection Documents Service

Vacuum Control A149

Capacitance Diaphragm Gauge

Porter CDG020D

The INFICON Porter CDG020D Capacitance Diaphragm Gauge is a high quality, cost effective, gas type independent absolute pressure sensor. The Porter is designed for stable long time performance in industrial environments. The ceramic sensor provides excellent span stability over many years of maintenance free operation paired with outstanding zero stability. The corrosion resistant single material sensor architecture guarantees excellent temperature compensation. Fully digital electronics and small footprint defines flexibility in any integration. The Porter vacuum gauge is humble, reliable, always available and never overpaid.

Advantages

- Excellent span stability—gas type independent
- Corrosion resistant alumina sensor
- Compact, smallest size in it's class
- Easy integration, any mounting orientation
- Digital signal processing
- Maintenance free

Applications

- Vacuum coating
- Vacuum monitoring
- Sterilization
- Food and packaging
- Vacuum oven, puller
- Analytical
- Chemical vacuum processes



Porter CDG020D (continued)

Ordering Information

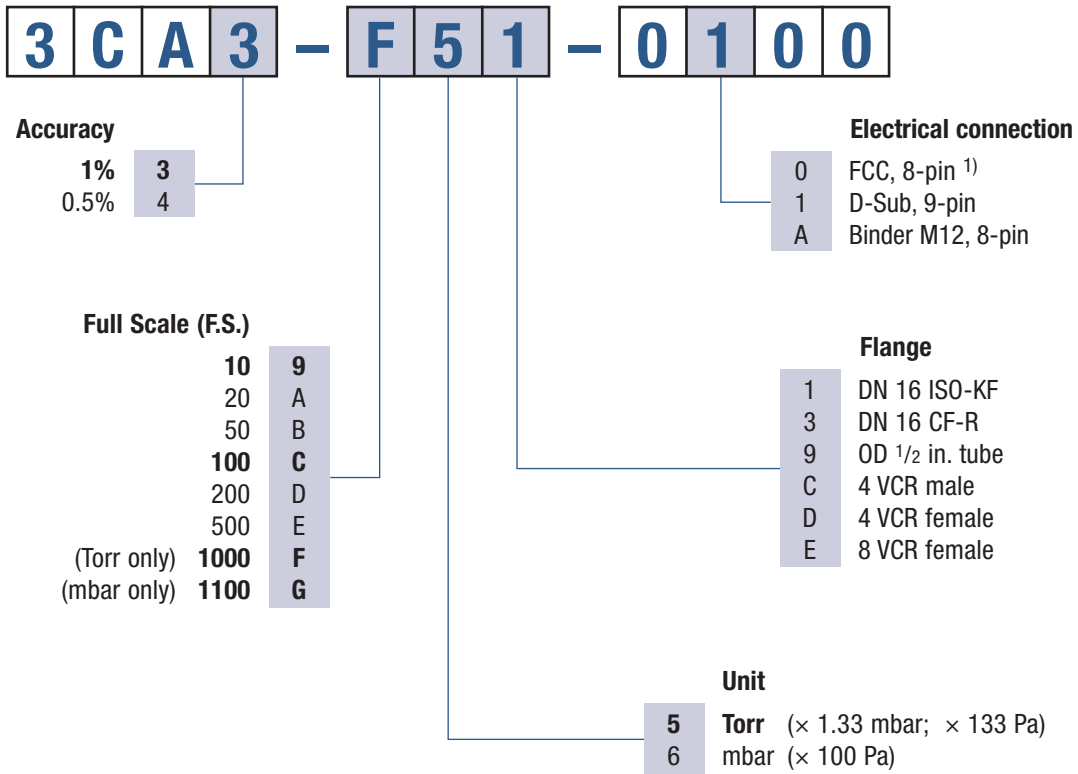

¹⁾ for use with INFICON controllers

bold = standard products

Other flange types and full scales (F.S.) on request.

Porter CDG020D (continued)

Specifications

Measurement Range F.S. (Full Scale)	Torr Pa mbar	1000 133,322 1333	100 13,332 133	10 1,333 13.3	500 66,661 667	200 26,664 267	50 6,666 66.7	20 2,666 27	110,000 1100	10,000 100	1000 10
Accuracy ¹⁾											
3CA3-xxx-xxx	% of reading					1					
3CA4-	% of reading					0.5					
Temperature effect											
On zero	% F.S. / °C					0.02					
On span	% of reading / °C					0.02					
Resolution	% F.S.					0.05					
Long time stability	% F.S. / year					<0.5					
Lowest reading	% F.S.					0.05					
Temperature compensated range	°C					+10 ... +50					
Admissible temperature											
Operation (ambient)	°C					0 ... +70					
Bakeout at flange ²⁾	°C					≤110					
Storage	°C					-20 ... +85					
Ambient humidity limits	% RH					<80%, non-condensing					
Supply voltage	V (dc)					+13 ... +30					
Power consumption	W					≤0.3					
Output signal (analog)	V (dc)					0 ... +10					
Max. output voltage	V (dc)					+10.24					
Response time ³⁾	ms					100					
Degree of protection						IP 40					
Standards											
CE conformity						EMC (EN 61000-6-2, EN 61000-6-3), EN 61010-1 and RoHS					
ETL certification						UL 61010-1, CAN/CSA C22.2 No. 61010-1					
SEMI compliance						SEMI S2					
Electrical connection											
3CAx-xxx-0000						FCC, 8-pin					
-0100						D-Sub, 9-pin, male					
-0A00						Binder M12, 8-pin, male					
Materials exposed to vacuum						Aluminum oxide ceramic (Al ₂ O ₃), stainless steel 1.4404 (AISI 316L),					
Tightness	mbar l/s					<1x10 ⁻⁹					
Mounting orientation						Any					
Internal volume											
DN 16 ISO-KF	cm ³ (in. ³)					3.7 (0.226)					
4 VCR male	cm ³ (in. ³)					6.1 (0.372)					
4 VCR female	cm ³ (in. ³)					5.6 (0.342)					
8 VCR female	cm ³ (in. ³)					5.1 (0.311)					
Weight											
DN 16 ISO-KF	g					~110					
4 VCR male	g					~123					
4 VCR female	g					~133					
8 VCR female	g					~159					
Maintenance						none					

¹⁾ Non-linearity, hysteresis, repeatability at 25°C ambient operating temperature without temperature effects after two hours operation.

²⁾ Non-operation

³⁾ Increase 10 ... 90% F.S.

Porter CDG020D (continued)

Dimensions

mm (in.)

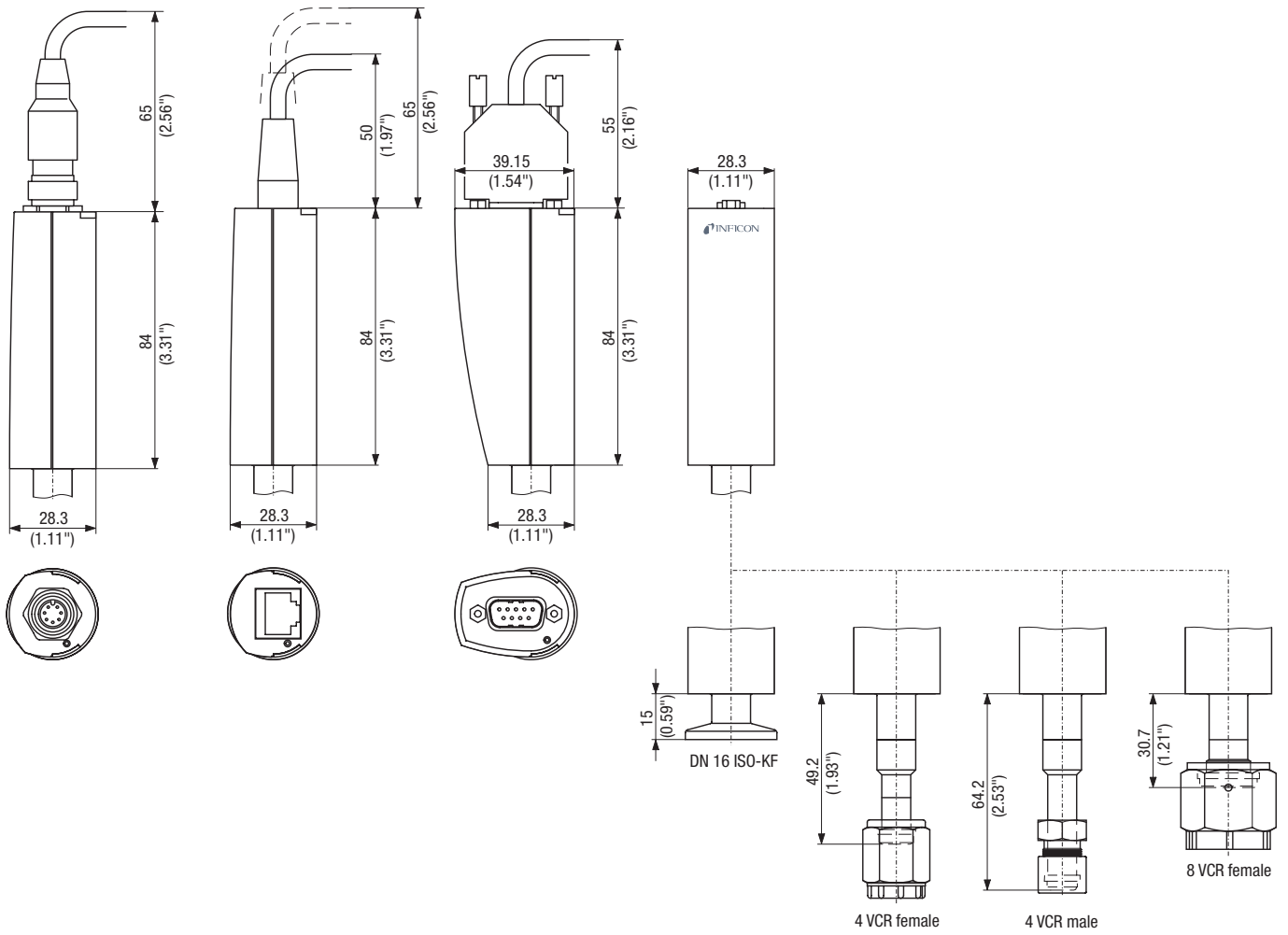

Capacitance Diaphragm Gauge

Sky CDG025D, CDG025D-S 0.1 ...1000 Torr/mbar

The INFICON SKY CDG025D Capacitance Diaphragm Gauge line of highly accurate temperature compensated manometers is designed for stable performance in harsh manufacturing tool environments. Advanced digital electronics improve gauge performance and offer easy handling features such as one push button zero function and setpoint adjustment. The corrosion resistant ultra pure ceramic sensor provides excellent zero stability with a long life expectancy of several million pressure cycles, including atmospheric bursts. A unique sensor shielding (patent pending) protects the gauge from process contamination. A robust mechanical design and digital electronics improve EMC compatibility, long term stability and temperature compensation. The CDG025D sets new standards for fast stability after power on and fast recovery from atmospheric pressure exposure.



Advantages

- Full scale ranges from 100 mTorr ... 1000 Torr
- Fast stability after power on
- Fast recovery from atmospheric pressure
- Corrosion resistant ceramic sensor
- Excellent long term signal stability
- Temperature compensated
- Sensor protected from contamination
- One push button zero function
- Wide range power supply
- Two setpoints (optional)
- RS232 interface (optional)

Applications

- Semiconductor manufacturing equipment for Etch, CVD, PVD, ALD
- Data storage and display manufacturing equipment
- Industrial vacuum equipment
- General high accuracy pressure measurement

Sky CDG025D, CDG025D-S 0.1 ...1000 Torr/mbar (continued)

Ordering Information

CDG025D, temperature compensated

Full Scale Range			Flange type			
Torr	Pascal	mbar	1/2 in. tube	DN 16 ISO-KF	DN 16 CF-R	8 VCR
1000	133,322	1333	375-000	375-001	375-002	375-003
100	13,332	133	376-000	376-001	376-002	376-003
10	1,333	13.3	377-000	377-001	377-002	377-003
1	133	1.3	378-000	378-001	378-002	378-003
0.1	13.3	0.13	379-000	379-001	379-002	379-003

CDG025D, with 2 setpoints and RS232 interface, temperature compensated

Full Scale Range			Flange type			
Torr	Pascal	mbar	1/2 in. tube	DN 16 ISO-KF	DN 16 CF-R	8 VCR
1000	133,322	1333	375-300	375-301	375-302	375-303
–	110,000	1,100	375-500	375-501	375-502	375-503
200	26,664	267	382-300	382-301	382-302	382-303
100	13,332	133	376-300	376-301	376-302	376-303
–	10,000	100	376-500	376-501	376-502	376-503
20	2,666	26.7	383-300	383-301	383-302	383-303
10	1,333	13.3	377-300	377-301	377-302	377-303
–	1,000	10	377-500	377-501	377-502	377-503
1	133	1.3	378-300	378-301	378-302	378-303
–	100	1	378-500	378-501	378-502	378-503
0.25	33.3	0.33	385-300	385-301	385-302	385-303
0.1	13.3	0.13	379-300	379-301	379-302	379-303
–	10	0.1	379-500	379-501	379-502	379-503

bold = standard products

Other flange types and full scale ranges on request.

Sky CDG025D, CDG025D-S 0.1 ...1000 Torr/mbar (continued)

Specifications (Torr based standard products)

Measurement Range F.S. (Full Scale)	Torr Pa mbar	1000 133,322 1333	100 13,332 133	10 1,333 13.3	1 133 1.3	0.1 13 0.13
Accuracy ¹⁾	% of reading	0.2	0.2	0.2	0.2	0.5
Temperature effect						
on zero	% F.S. / °C	0.005	0.005	0.005	0.015	0.02
on span	% of reading / °C	0.01	0.01	0.01	0.01	0.03
Resolution	% F.S.	0.003	0.003	0.003	0.003	0.003
Pressure, max.	kPa (absolute)	400	260	260	260	130
Response time ²⁾	ms	30	30	30	30	130
Lowest reading	% F.S.			0.01		
Lowest suggested reading	% F.S.			0.05		
Lowest suggested control pressure	% F.S.			0.5		
Temperature						
Operation (ambient)	°C			+5 ... +50		
Bakeout at flange ³⁾	°C			≤110		
Storage	°C			-20 ... +65		
Supply voltage	V (dc)			14 ... 30		
Power consumption	W			≤1		
Output signal (analog)	V (dc)			0 ... +10		
Degree of protection				IP 30		
Standards		EN 61000-6-2, EN 61000-6-3, EN 61010, UL 61010-1, CSA 22.2 No.61010-1, RoHS				
Electrical connection		D-sub, 15 pole, male				
Setpoint ⁴⁾		Two setpoints (SP1, SP2)				
Relay contact	V (dc) / A (dc)	30 / ≤0.5				
Hysteresis	% F.S.	1				
Materials exposed to vacuum		Aluminum oxide ceramic (Al ₂ O ₃), Vacon 70 ⁵⁾ , stainless steel (AISI 316L ⁶⁾ , AgCuTi hard solder, sealing glass				

¹⁾ Non-linearity, hysteresis, repeatability at 25°C ambient operating temperature without temperature effects after two hours operation.

²⁾ Increase 10 ... 90% F.S.

³⁾ Non-operation

⁴⁾ CDG025D-S only

⁵⁾ 28% Ni, 23% Co, 49% Fe

⁶⁾ 18% Cr, 10% Ni, 3% Mo, 69% Fe

Sky CDG025D, CDG025D-S 0.1 ...1000 Torr/mbar (continued)

Specifications (Torr based other ranges)

Measurement Range F.S. (Full Scale)	Torr Pa mbar	- 110,000 1000	200 26,664 267	- 10,000 100	20 2,666 26.7	- 1,000 10	- 100 1	0.25 33.3 0.33	- 10 0.1
Accuracy ¹⁾	% of reading	0.2	0.2	0.2	0.2	0.2	0.2	0.25	0.5
Temperature effect on zero	% F.S./ °C	0.005	0.005	0.005	0.005	0.005	0.015	0.02	0.02
on span	% of reading/ °C	0.01	0.01	0.01	0.01	0.01	0.01	0.03	0.03
Resolution	% F.S.	0.003	0.003	0.003	0.003	0.003	0.003	0.003	0.003
Pressure, max.	kPa (absolute)	400	260	260	260	260	260	130	130
Response time ²⁾	ms	30	30	30	30	30	30	130	130

¹⁾ Non-linearity, hysteresis, repeatability at 25°C ambient operating temperature without temperature effects after two hours operation.

²⁾ Increase 10 ... 90% F.S.

For further specifications, see table above.

Dimensions, Internal Volume, Weight

mm (in.)

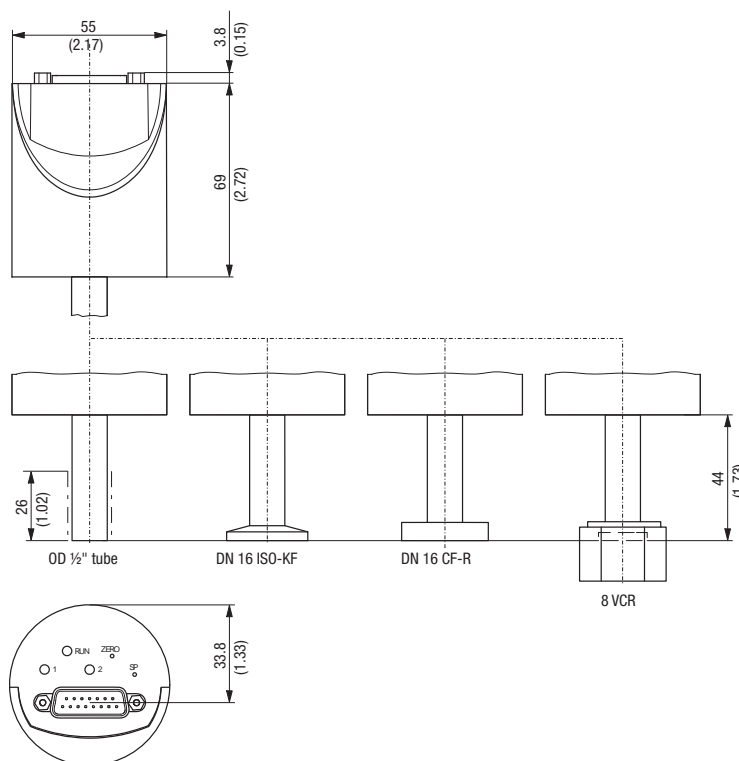

		1/2 in. tube	DN 16 ISO KF	DN 16 CF-R	8 VCR
Internal volume	cm ³ (in. ³)	3.6 (0.22)	3.6 (0.22)	3.6 (0.22)	3.6 (0.22)
Weight	g	310	330	350	370

Capacitance Diaphragm Gauge

Sky CDG025D-X3 0.1 ...1000 Torr/mbar

The INFICON SKY CDG025D Capacitance Diaphragm Gauge line of highly accurate temperature compensated manometers is designed for stable performance in harsh manufacturing tool environments. Advanced digital electronics improve gauge performance and offer easy handling features such as one push button zero function and setpoint adjustment. The corrosion resistant ultra pure ceramic sensor provides excellent zero stability with a long life expectancy of several million pressure cycles, including atmospheric bursts. A unique sensor shielding (patent pending) protects the gauge from process contamination. A robust mechanical design and digital electronics improve EMC compatibility, long term stability and temperature compensation. The CDG025D sets new standards for fast stability after power on and fast recovery from atmospheric pressure exposure.

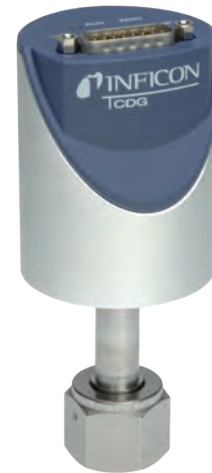

Advantages

- Full scale ranges from 100 mTorr ... 1000 Torr
- Fast stability after power on
- Fast recovery from atmospheric pressure
- Corrosion resistant ceramic sensor
- Excellent long term signal stability
- Temperature compensated
- Sensor double protected from contamination
- One push button zero function
- Wide range power supply
- Two setpoints
- RS232 interface
- Clean room compliant

Applications

Accurate and fast pressure measurement for demanding applications:

- Semiconductor manufacturing equipment for Etch, CVD, PVD, ALD
- Data storage and display manufacturing equipment
- Industrial vacuum equipment
- General high accuracy pressure measurement

Sky CDG025D-X3 0.1 ...1000 Torr/mbar (continued)

Ordering Information

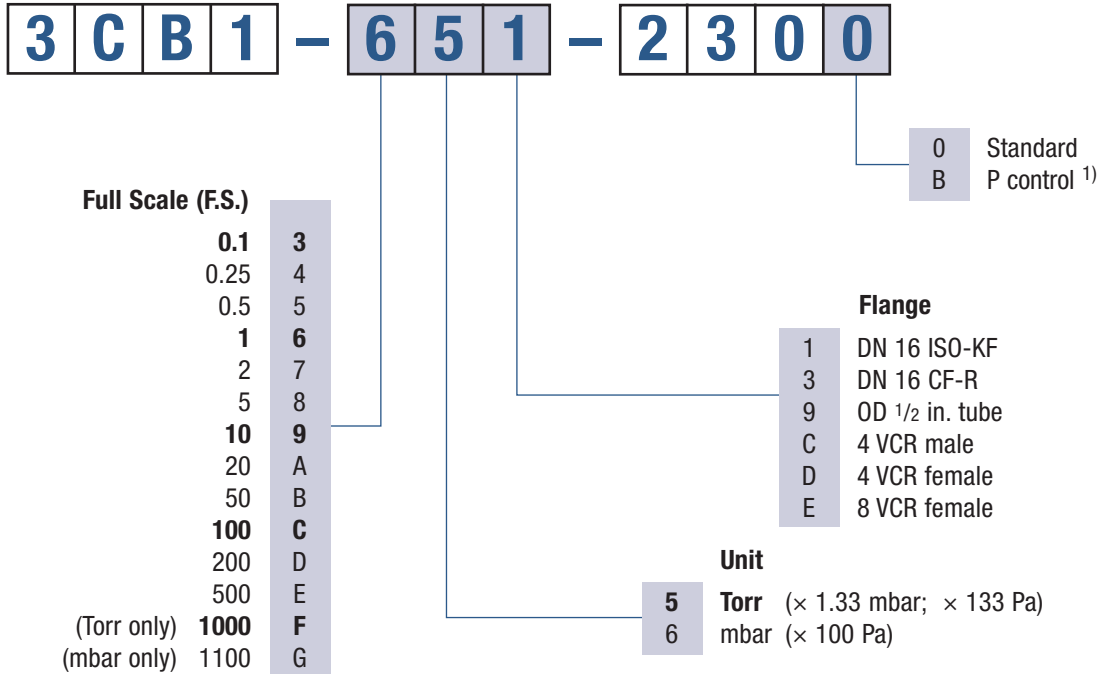

¹⁾ Optimized signal filter setting for pressure control.

bold = standard products

Other flange types and full scale ranges (F.S.) on request.

Sky CDG025D-X3 0.1 ...1000 Torr/mbar (continued)

Specifications (Torr based standard products)

Measurement Range F.S. (Full Scale)	Torr Pa mbar	1000 133,322 1333	100 13,332 133	10 1,333 13.3	1 133 1.3	0.1 13 0.13
Accuracy ¹⁾	% of reading	0.2	0.2	0.2	0.2	0.5
Temperature effect						
on zero	% F.S. / °C	0.005	0.005	0.005	0.015	0.02
on span	% of reading / °C	0.01	0.01	0.01	0.01	0.03
Resolution	% F.S.	0.003	0.003	0.003	0.003	0.003
Pressure, max.	kPa (absolute)	400	260	260	260	130
Response time ²⁾	ms	30	30	30	30	130 / 30 ³⁾
Lowest reading	% F.S.			0.01		
Lowest suggested reading	% F.S.			0.05		
Lowest suggested control pressure	% F.S.			0.5		
Temperature						
Operation (ambient)	°C			+5 ... +50		
Bakeout at flange ⁴⁾	°C			≤110		
Storage	°C			-20 ... +65		
Supply voltage	V (dc)			+14 ... +30		
Power consumption	W			≤1		
Output signal (analog)	V (dc)			0 ... +10		
Degree of protection				IP 30		
Standards		EN 61000-6-2, EN 61000-6-3, EN 61010, UL 61010-1, CSA 22.2 No.61010-1, RoHS				
Electrical connection		D-Sub, 15-pin, male				
Setpoint		Two setpoints (SP1, SP2)				
Relay contact	V (dc) / A (dc)	30 / ≤0.5				
Hysteresis	% F.S.	1				
Materials exposed to vacuum		Aluminum oxide ceramic (Al ₂ O ₃), stainless steel (AISI 316L ⁵⁾)				

¹⁾ Non-linearity, hysteresis, repeatability at 25°C ambient operating temperature without temperature effects after two hours operation.

²⁾ Increase 10 ... 90% F.S.

³⁾ For pressure control type only

⁴⁾ Non-operation

⁵⁾ 18% Cr, 10% Ni, 3% Mo, 69% Fe

Sky CDG025D-X3 0.1 ...1000 Torr/mbar (continued)

Specifications (Torr based other ranges)

Measurement Range F.S. (Full Scale)	Torr Pa mbar	– 110,000 1100	200 26,664 267	– 10,000 100	20 2,666 26.7	– 1,000 10	– 100 1	0.25 33.3 0.33	– 10 0.1
Accuracy ¹⁾	% of reading	0.2	0.2	0.2	0.2	0.2	0.2	0.25	0.5
Temperature effect									
on zero	% F.S. / °C	0.005	0.005	0.005	0.005	0.005	0.015	0.02	0.02
on span	% of reading / °C	0.01	0.01	0.01	0.01	0.01	0.01	0.03	0.03
Pressure, max.	kPa (absolute)	236	260	260	260	260	260	130	130
Resolution	% F.S.	0.003	0.003	0.003	0.003	0.003	0.003	0.003	0.003
Response time ²⁾	ms	30	30	30	30	30	30	130	130 / 30 ³⁾

¹⁾ Non-linearity, hysteresis, repeatability at 25°C ambient operating temperature without temperature effects after two hours operation.

²⁾ Increase 10 ... 90% F.S.

³⁾ For pressure control type only

Further specifications see table above.

Dimensions, Internal Volume, Weight

mm (in.)

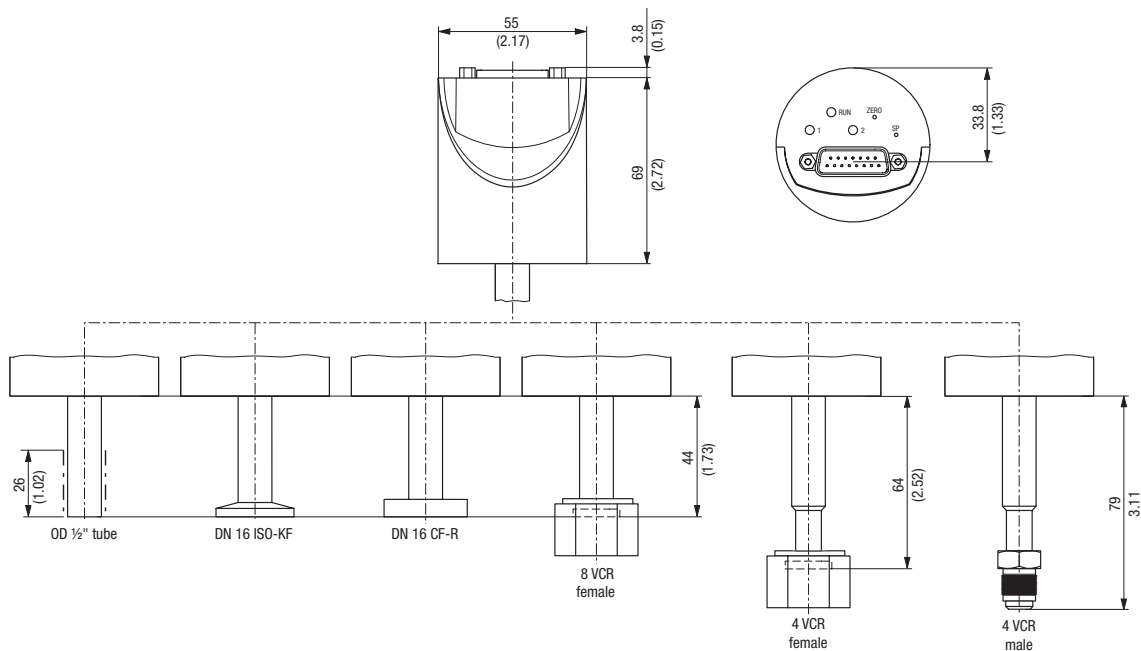

		1/2 in. tube	DN 16 ISO KF	DN 16 CF-R	8 VCR
Internal volume	cm ³ (in. ³)	3.6 (0.22)	3.6 (0.22)	3.6 (0.22)	3.6 (0.22)
Weight	g	310	330	350	370

Capacitance Diaphragm Gauge

Sky CDG025D-X3 4–20mA current loop 0.1 ...1000 Torr/mbar

The INFICON SKY CDG025D Capacitance Diaphragm Gauge line of highly accurate temperature compensated manometers is designed for stable performance in harsh manufacturing tool environments. Advanced digital electronics improve gauge performance and offer easy handling features such as one push button zero function and setpoint adjustment. The corrosion resistant ultra pure ceramic sensor provides excellent zero stability with a long life expectancy of several million pressure cycles, including atmospheric bursts. A unique sensor shielding (patent pending) protects the gauge from process contamination. A robust mechanical design and digital electronics improve EMC compatibility, long term stability and temperature compensation. The CDG025D sets new standards for fast stability after power on and fast recovery from atmospheric pressure exposure.



Advantages

- Full scale ranges from 100 mTorr ... 1000 Torr
- Fast stability after power on
- Fast recovery from atmospheric pressure
- Corrosion resistant ceramic sensor
- Excellent long term signal stability
- Temperature compensated
- Sensor double protected from contamination
- One pushbutton zero function
- Interface with 2-wire current loop
- Long cable distance (<300m)
- Low energy gauge
- Remote zero included
- Clean room compliant
- Status LED

Applications

- Semiconductor manufacturing equipment for Etch, CVD, PVD, ALD
- Data storage and display manufacturing equipment
- Industrial vacuum equipment
- General high accuracy pressure measurement

Sky CDG025D-X3 4–20mA current loop (continued)

Ordering Information

3 C B 1 - 6 5 1 - 0 1 E 0

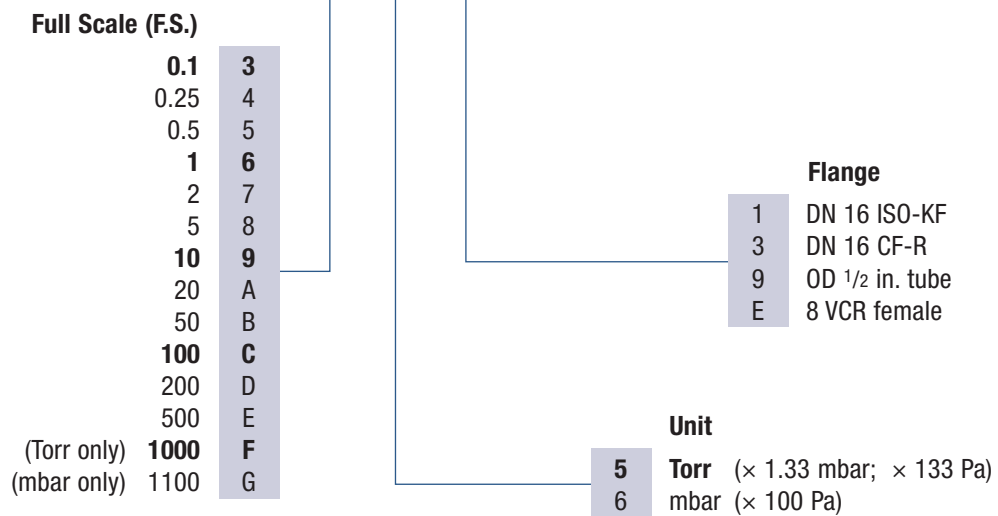

bold = standard products

Other flange types and full scale ranges (F.S.) on request.

Sky CDG025D-X3 4–20mA current loop (continued)

Specifications (Torr based standard products)

Measurement Range F.S. (Full Scale)	Torr Pa mbar	1000 133.332 1100	500...10 66.661...1.333 66.7...13.3	1 133 1.3	0.25 33.3 0.33	0.1 13 0.13
Accuracy ¹⁾	% of reading	0.2	0.2	0.2	0.25	0.5
Temperature effect						
on zero	% F.S. / °C	0.005	0.005	0.015	0.02	0.02
on span	% of reading / °C	0.01	0.01	0.01	0.03	0.03
Resolution	% F.S.	0.003	0.003	0.003	0.003	0.003
Pressure, max.	kPa (absolute)	300	200	200	200	130
Response time ²⁾	ms	≤100	≤100	≤100	≤100	≤100
Lowest reading	% F.S.			0.01		
Lowest suggested reading	% F.S.			0.05		
Lowest suggested control pressure	% F.S.			0.5		
Temperature						
Operation (ambient)	°C			+5 ... +60		
Bakeout at flange ³⁾	°C			≤110		
Storage	°C			-20 ... +65		
Supply voltage	V (dc)			+21 ... +27		
Output signal (analog)				2-wire, current loop		
Relationship current-pressure				linear		
Signal range	mA			3.8 ... 20.2		
Measuring range (zero ... FS)	mA			4.0 ... 20.0		
Loaded impedance RL						
Ω				typical 500Ω±1% 24±3 V (dc) ⁴⁾		
absolute				309 ... 657Ω at 24 V (dc) ⁴⁾		
remote zero input				digital input, floating contact		
High level (pulse > 1s)				+21 ... +27 V (dc) / ≤8 mA		
Low level				≤2		
remote zero function						
High level (pulse > 1s)				auto zero adjust		
Low level				measurement operation		
Degree of protection				IP 30		
Standards						
CE conformity				EN 61000-6-3, EN 61010, 61326-1 & RoHS		
ETL certification				UL 61010-1, CSA 22.2 No.61010-1		
Electrical connection				D-Sub, 9-pin, male		
Sensor cable						
Without remote zero				two-wire cable plus shielding, twisted		
With remote zero				four-wire cable plus shielding, twisted		
Materials exposed to vacuum				Aluminum oxide ceramic (Al ₂ O ₃), stainless steel (AISI 316L ⁵⁾)		
Internal volume						
I. volume 1/2" tube	cm ³ (in. ³)			3.6 (0.22)		
I. volume DN 16 ISO-KF	cm ³ (in. ³)			3.6 (0.22)		
I. volume DN 16 CF-R	cm ³ (in. ³)			3.6 (0.22)		
I. volume 8 VCR [®]	cm ³ (in. ³)			3.6 (0.22)		

Sky CDG025D-X3 4-20mA current loop (continued)

Specifications (Torr based standard products)

Measurement Range	Torr	1000	500...10	1	0.25	0.1
F.S. (Full Scale)	Pa	133.332	66.661...1.333	133	33.3	13
	mbar	1100	66.7...13.3	1.3	0.33	0.13
Weight						
1/2 in. tube	g			310		
DN 16 ISO-KF	g			330		
DN 16 CF-R	g			350		
8 VCR®	g			370		

- 1) Non-linearity, hysteresis, repeatability at 25°C ambient operating temperature without temperature effects after two hours operation.
- 2) Increase 10 ... 90% F.S.
- 3) Non operation
- 4) Supply voltage at the gauge
- 5) 18% Cr, 10% Ni, 3% Mo, 69% Fe

Dimensions

mm (in.)

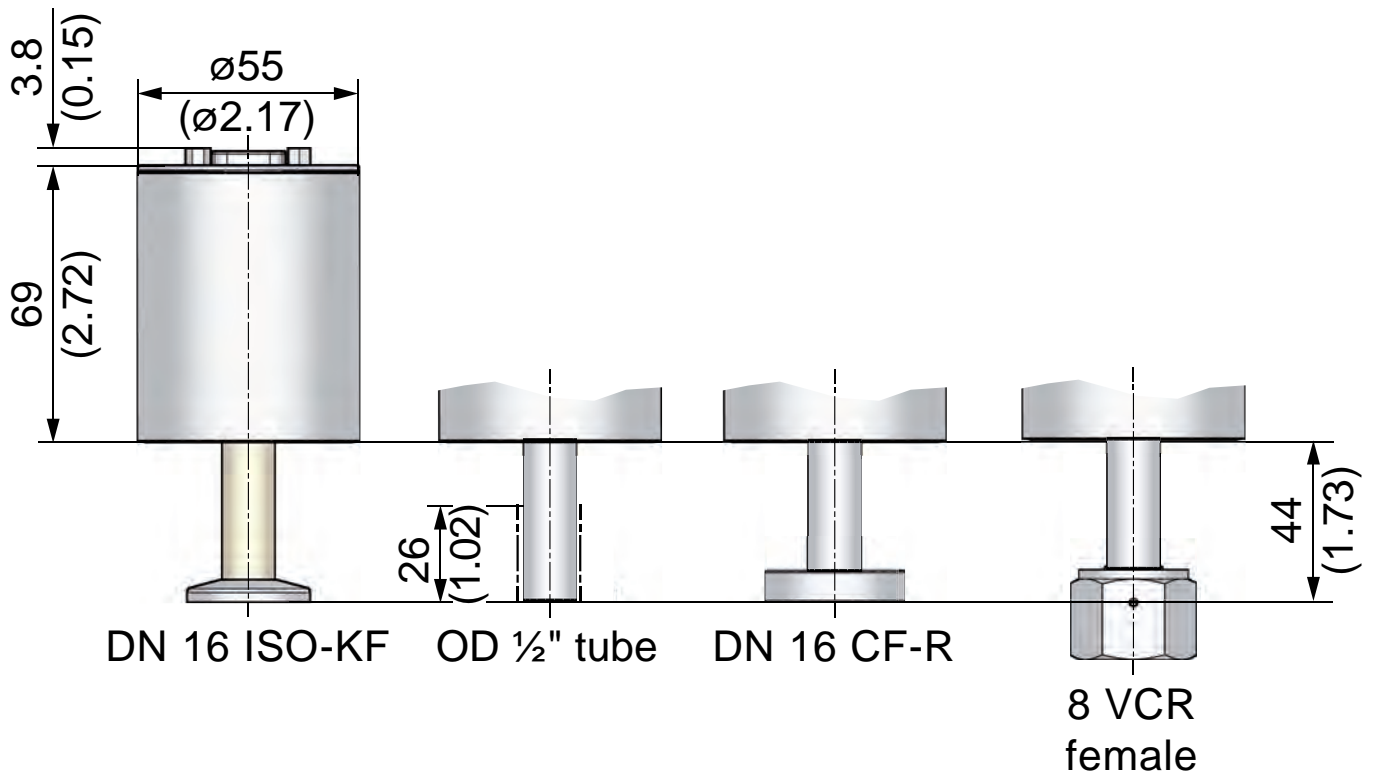

Capacitance Diaphragm Gauge

Edge CDG025D2 with EtherCAT 0.1... 1000Torr/mbar

INFICON temperature compensated Edge CDG025D2 with EtherCAT Capacitance Diaphragm Gauge is a highly accurate vacuum measurement instrument designed for harsh manufacturing environments.

The proven temperature compensated, corrosion resistant, ultra-pure ceramic sensor provides superior span stability over many years paired with state-of-the-art zero stability. Edge comes with the INFICON patented unique sensor shield which protects the gauge from undesired process by-products. Advanced electronics offer a wide range of configurable signal conditioning for all applications with EtherCAT fieldbus interface..



Advantages

- Easy integration, EtherCAT, wide variety of full scales and flanges, standard with two set points
- Easy one push button or remote signal zero command, zero offset adjustable
- Diagnostic port for quick service and maintenance
- Corrosion resistant ceramic sensor
- Excellent long term signal stability
- Temperature compensated
- Sensor protected from contamination
- Compliance & standards: CE, EN, UL, SEMI, RoHS

Applications

- Semiconductor manufacturing equipment for Etch, CVD, PVD, ALD
- Data storage and display manufacturing equipment
- Industrial vacuum equipment
- General high accuracy pressure measurement

Edge CDG025D2 with EtherCAT 0.1 ... 1000Torr/mbar (continued)

Ordering Information

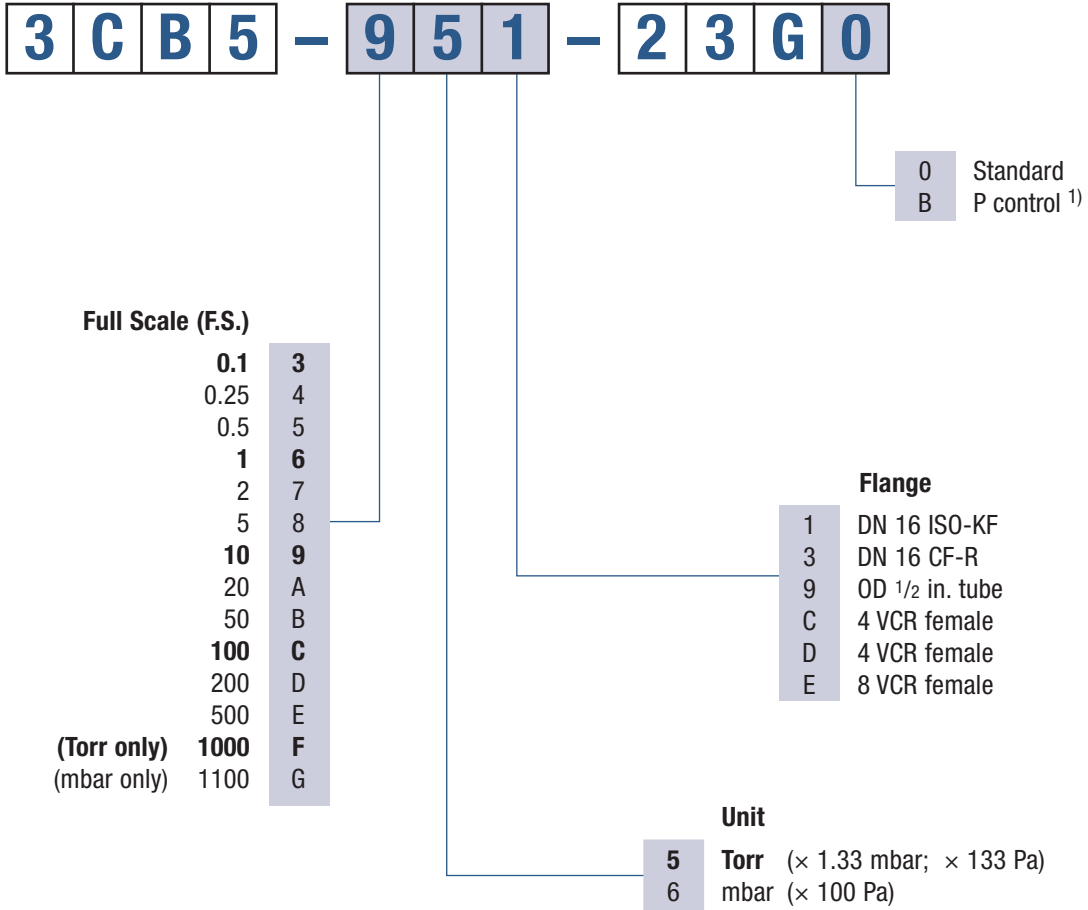

¹⁾ Optimised signal filter setting for pressure control

bold = standard products

Other flange types and full scales (F.S.) on request.

Edge CDG025D2 with EtherCAT 0.1 ... 1000Torr/mbar (continued)

Specifications (Torr based standard products)

Measurement Range F.S. (Full Scale)	Torr Pa mbar	1000 133.322 1100	500 ... 10 66.661 ... 1.333 133 ... 13.3	1 133 1.3	0.25 33.3 0.33	0.1 13 0.13
Accuracy ¹⁾	% of reading	0.2	0.2	0.2	0.25	0.5
Temperature effect						
on zero	% F.S./ °C	0.005	0.005	0.015	0.02	0.02
on span	% of reading/ °C	0.01	0.01	0.01	0.03	0.03
Pressure, max.	kPa (absolute)	400	260	260	130	130
Resolution	% F.S.	0.003				
Lowest reading	% F.S.	0.01				
Lowest suggested reading	% F.S.	0.05				
Lowest suggested control pressure	% F.S.	0.5				
Temperature						
Sensor	°C	25				
Operation (ambient)	°C	+5 ... +50				
Bakeout at flange	°C	≤110				
Storage	°C	-20 ... +65				
Supply voltage	V (dc)	+14 ... +30 VDC or ± 15 V (±5%)				
Power consumption						
At operating temperature	W	≤1				
Output signal (analog)	V (dc)	0 ... +10				
Response time ²⁾	ms	30			130	130/30 ³⁾
Degree of protection		IP 40				
Standards						
CE conformity		EN 61000-6-2/-6-3, EN 61010 & RoHS				
ETL certification		UL 61010-1, CSA 22.2 No.61010-1				
SEMI compliance		SEMI S2				
Electrical connection		D-sub, 15 pole, male				
Setpoint						
Number of setpoints		2 (SP1, SP2)				
Relay contact	V (dc)	≤30				
	A (dc)	≤0.5				
Hysteresis	% F.S.	1				
Diagnostic port						
Protocol		RS232-C				
Read		pressure, status, ID				
Set		set points, filter, zero adjust, factory reset, DC offset				
Materials exposed to vacuum		Aluminum oxide ceramic (Al ₂ O ₃), stainless steel (AISI 316L ⁴⁾)				
Internal volume						
1/2" tube	cm ³ (in. ³)	4.2 (0.26)				
DN 16 ISO-KF	cm ³ (in. ³)	4.2 (0.26)				
DN 16 CF-R	cm ³ (in. ³)	4.2 (0.26)				
8 VCR®	cm ³ (in. ³)	4.2 (0.26)				
Weight						
1/2" tube	g	837				
DN 16 ISO-KF	g	852				
DN 16 CF-R	g	875				
8 VCR®	g	897				

Edge CDG025D2 with EtherCAT 0.1 ... 1000Torr/mbar (continued)

Specifications (Torr based standard products)

Measurement Range	Torr	1000	500 ... 10	1	0.25	0.1
F.S. (Full Scale)	Pa	133.322	66.661 ... 1.333	133	33.3	13
	mbar	1100	133 ... 13.3	1.3	0.33	0.13
EtherCAT						
Protocol EtherCAT					protocol specialized for EtherCAT	
Communication standards					ETG.5003 Part 1 "Semiconductor Device Profile" ETG.5003 Part 2080 "Specific Device Profile: Vacuum Pressure Gauge Explicit Device Identification	
Node address					100BASE-Tx (IEEE802.3)	
Physical layer					pressure, status, ID	
Digital functions	read				set points, filter, zero adjust, reset, DC offset	
	set				SDO requests, responses and information	
Mailbox (CoE)					Fixed PDO mapping and configurable PDO mapping	
Process data					RJ45, 8-pin (socket), IN and OUT	
EtherCAT connector					shielded Ethernet CAT5e or higher	
Cable						
EtherCAT						
Data rate	Kbps				100000	
Cable length	m (ft.)				≤100 (330)	

- 1) Non-linearity, hysteresis, repeatability at 25°C ambient operating temperature without temperature effects after two hours operation.
- 2) Increase 10 ... 90% F.S.
- 3) For pressure control type only
- 4) 18% Cr, 10% Ni, 3% Mo, 69% Fe

Dimensions

mm (in.)

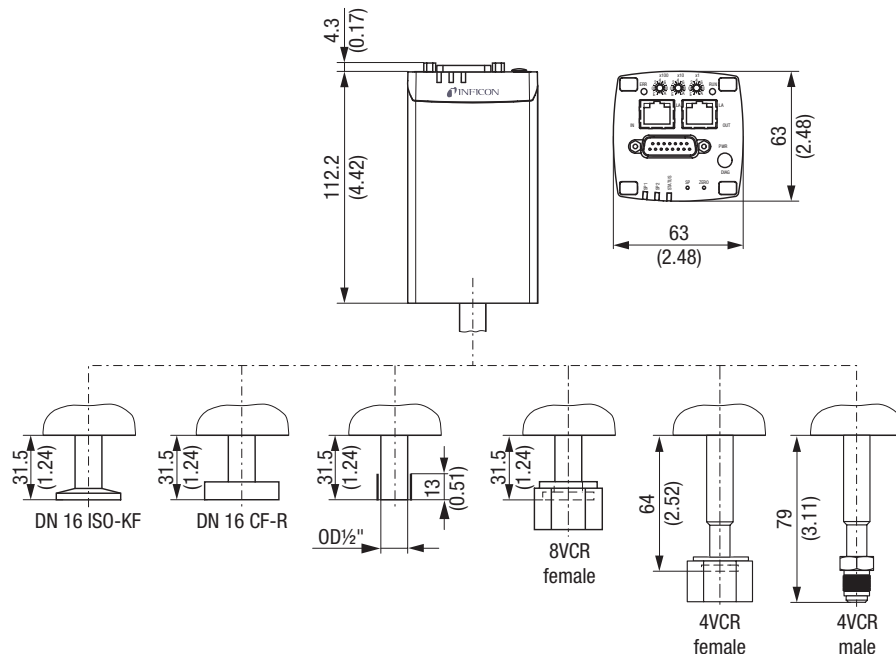

Capacitance Diaphragm Gauge

Sky CDG045D 0.05 ...1000 Torr/mbar

INFICON SKY CDG045D manometers are your best choice for highly accurate total pressure measurement and control. CDG045D gauges are temperature controlled at 45°C for superior signal stability and repeatability. They are available for full scale ranges from 50 mTorr

to 1000 Torr, with all common flange types and fieldbus interfaces and provide a linear 0 to 10 V, gas type independent, pressure signal. INFICON capacitance manometers use a corrosion proof ultra pure alumina ceramic diaphragm. The advantages of the ceramic sensor are better signal stability, faster recovery from atmosphere, short warm up time and an extraordinary lifetime. INFICON CDG are high quality, cost effective pressure sensors for demanding vacuum applications.



Advantages

- Lower cost of ownership, 50% faster warm up, energy efficient low power consumption
- Easy integration, wide variety of full scales, flanges and interfaces, standard with two set points
- Easy one push button or remote signal zero command, zero offset adjustable
- Diagnostic port for quick service and maintenance
- Two year warranty, longer lifetime with advanced heating concept and gauge protection
- No long term recalibration due to excellent signal stability and repeatability, even in harsh plasma applications
- Compliance and standards: CE, EN, UL, SEMI, RoHS

Applications

- Etch, CVD, PVD and other semiconductor production processes
- Chemical and corrosive vacuum processes
- General thin film and vacuum processes
- Reference sensor for monitoring of test instruments according to international standards
- Transfer standard for traceability measurements

Sky CDG045D 0.05 ...1000 Torr/mbar (continued)

Ordering Information

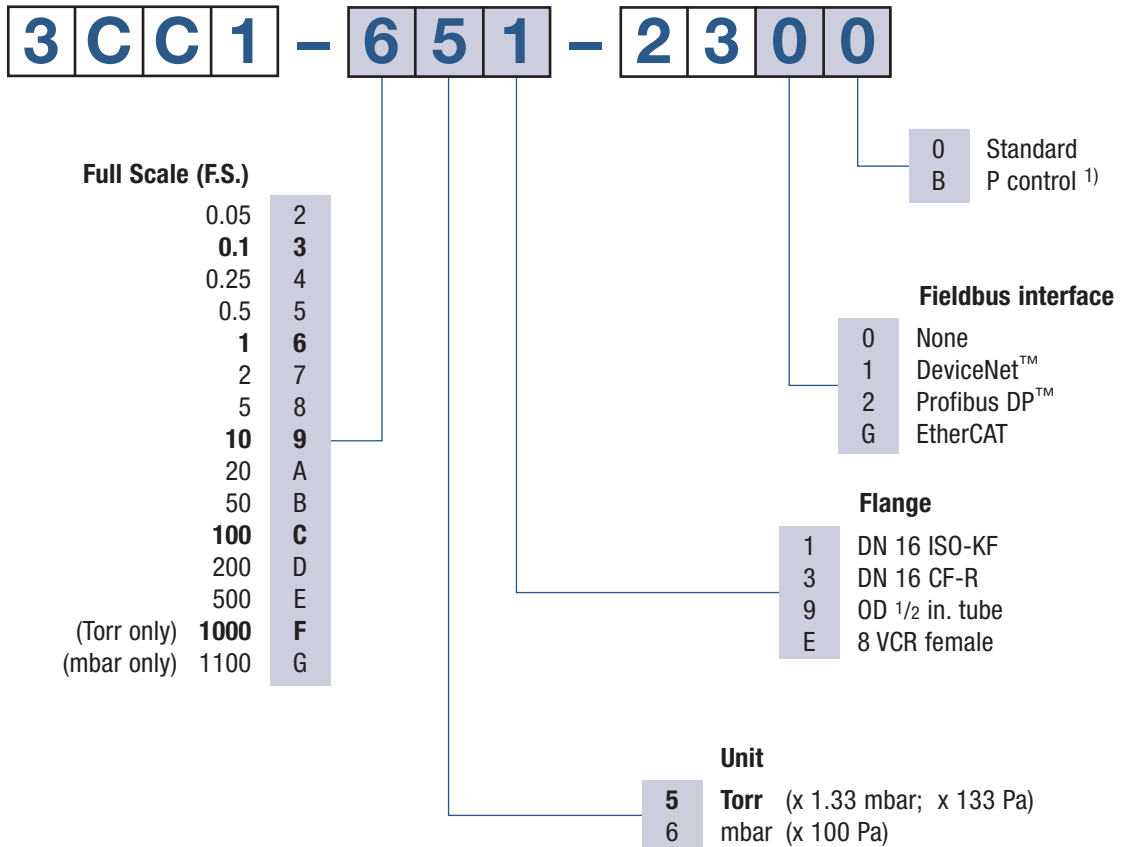

1) Optimized signal filter setting for pressure control

bold = standard products

Other flange types and full scale ranges (F.S.) on request.

Accessories

	Diagnostic
Communication adapter (2 m) for PC RS232 serial port	303-333

Software to run the diagnostic functions on Windows NT, XP can be downloaded from our website.

Sky CDG045D 0.05 ...1000 Torr/mbar (continued)

Specifications (Torr based standard products)

Type		1000 Torr, 1100 mbar	500 ... 1 Torr / mbar	0.5 ... 0.05Torr / mbar
Accuracy (1)	% of reading	0.15	0.15	0.15
Temperature effect on zero	percent FS/°C	0.0025	0.0025	0.005
Temperature effect on span	% of reading / °C	0.01	0.01	0.01
Pressure, max.	kPa (absolute)	400	260	130
Resolution	percent FS	0.003	0.003	0.003
Lowest reading	percent FS	0.01	0.01	0.01
Lowest suggested reading	percent FS	0.05	0.05	0.05
Lowest suggested control pressure	percent FS	0.5	0.5	0.5
Temperature				
Operation (ambient)	°C	+10 ... +40	+10 ... +40	+10 ... +40
Bakeout at flange	°C	≤110	≤110	≤110
Storage	°C	-20 ... +65	-20 ... +65	-20 ... +65
Supply voltage		+14 ... +30 V (dc) or ±15 V (±5%)	+14 ... +30 V (dc) or ±15 V (±5%)	+14 ... +30 V (dc) or ±15 V (±5%)
Power consumption				
During Heat up	W	≤12	≤12	≤12
At operating temperature	W	≤8	≤8	≤8
Output signal (analog)	V (dc)	0 ... +10	0 ... +10	0 ... +10
Response time (2)	ms	30	30	130/30 ³⁾
Degree of protection		IP 40	IP 40	IP 40
Standards				
CE conformity		EN 61000-6-2/-6-3, EN 61010 & RoHS	EN 61000-6-2/-6-3, EN 61010 & RoHS	EN 61000-6-2/-6-3, EN 61010 & RoHS
ETL certification		UL 61010-1, CSA 22.2 No.61010-1	UL 61010-1, CSA 22.2 No.61010-1	UL 61010-1, CSA 22.2 No.61010-1
SEMI compliance		SEMI S2	SEMI S2	SEMI S2
Electrical connection		D-sub, 15 pole, male	D-sub, 15 pole, male	D-sub, 15 pole, male
Setpoint				
Number of setpoints		2 (SP1,SP2)	2 (SP1,SP2)	2 (SP1,SP2)
Setpoint				
Relay contact	V (dc)	≤30	≤30	≤30
Relay contact	A (dc)	≤0.5	≤0.5	≤0.5
Setpoint				
Hysteresis	percent FS	1	1	1
Diagnostic port				
Protocol		RS232-C	RS232-C	RS232-C
Read		pressure, status, ID set points, filter, zero adjust, factory reset, DC offset	pressure, status, ID set points, filter, zero adjust, factory reset, DC offset	pressure, status, ID set points, filter, zero adjust, factory reset, DC offset
Set				
Materials exposed to vacuum		Aluminum oxide ceramic (Al ₂ O ₃), stainless steel (AISI 316l ⁴⁾)	Aluminum oxide ceramic (Al ₂ O ₃), stainless steel (AISI 316l ⁴⁾)	Aluminum oxide ceramic (Al ₂ O ₃), stainless steel (AISI 316l ⁴⁾)

Sky CDG045D 0.05 ...1000 Torr/mbar (continued)

Specifications (Torr based standard products)

Type		1000 Torr, 1100 mbar	500 ... 1 Torr / mbar	0.5 ... 0.05Torr / mbar
Internal volume				
I. volume 1/2 in. tube	cm ³ (in. ³)	4.2 (0.26)	4.2 (0.26)	4.2 (0.26)
I. volume DN 16 ISO KF	cm ³ (in. ³)	4.2 (0.26)	4.2 (0.26)	4.2 (0.26)
I. volume DN 16 CF-R	cm ³ (in. ³)	4.2 (0.26)	4.2 (0.26)	4.2 (0.26)
I. volume 8 VCR	cm ³ (in. ³)	4.2 (0.26)	4.2 (0.26)	4.2 (0.26)
Weight				
Weight 1/2 in. tube	g	837	837	837
Weight DN 16 ISO KF	g	852	852	852
Weight DN 16 CF-R	g	875	875	875
Weight 8 VCR	g	897	897	897

¹⁾ Non-linearity, hysteresis, repeatability at 25°C ambient operating temperature without temperature effects after two hours operation

²⁾ Increase 10 ... 90% F.S.

³⁾ For pressure control type only

⁴⁾ 18% Cr, 10% Ni, 3% Mo, 69% Fe

Specifications (Torr based other ranges)

Measurement Range F.S. (Full Scale)	Torr Pa mbar	500 66,661 666.61	200 26,664 267	50 6,666.1 66.67	20 2,666 26.7	5 666.61 6.6661	2 266.66 2.67	0.5 66.66 0.67	0.25 33.3 0.33		
Accuracy ¹⁾	% of reading	0.15									
Temperature effect											
on zero	% F.S. / °C	0.0025					0.005				
on span	% of reading / °C	0.01									
Pressure, max.	kPa (absolute)	400			260			130			
Response time ²⁾	ms	30					130				

¹⁾ Non-linearity, hysteresis, repeatability at 25°C ambient operating temperature without temperature effects after two hours operation.

²⁾ Increase 10 ... 90% F.S.

Further specifications see table above.

Specifications (mbar based products)

Measurement Range F.S. (Full Scale)	mbar Pa	1100 110,000	100 10,000	10 1,000	1 100	0.1 10
Accuracy ¹⁾	% of reading	0.15				
Temperature effect						
on zero	% F.S. / °C	0.0025				0.005
on span	% of reading / °C	0.01				
Pressure, max.	kPa (absolute)	400		260		130
Response time ²⁾	ms	30				130 / 30 ³⁾

¹⁾ Non-linearity, hysteresis, repeatability at 25°C ambient operating temperature without temperature effects after two hours operation.

²⁾ Increase 10 ... 90% F.S.

³⁾ For pressure control type only

⁴⁾ 18% Cr, 10% Ni, 3% Mo, 69% Fe

Further specifications see tables «SPECIFICATIONS (Torr based standard products)» and «SPECIFICATIONS (Torr based other products)».

Sky CDG045D 0.05 ...1000 Torr/mbar (continued)

Specifications (DeviceNet)

		CDG045D DeviceNet
Protocol		DeviceNet, group 2 slave only
Data rate	kBaud	125, 250, 500 by switch or network programmable
Cable length		
125 kbps	m (ft.)	500 (1650)
250 kbps	m (ft.)	250 (825)
500 kbps	m (ft.)	100 (330)
MAC ID		address 00 - 63 by switch or network programmable
Digital functions	read set	pressure, status, ID set points, filter, zero adjust, factory reset, DC offset
Specification		DeviceNet "Vacuum Gauge Device Profile" (ODVA)
Device type		"VG" vacuum gauge
I/O slave messaging		polling only
Supply voltage for gauge at D-sub connector		+14 ... +30 V (dc) or ± 15 V / ≤ 12 W
Supply voltage for DeviceNet transceiver at microstyle connector		24 V nom / < 2 W (11 ... 25 V)
Connector for DeviceNet		microstyle, 5 pin, male
Connector for CDG (analog output, supply voltage CDG, setpoints)		D-sub, 15 pin, male

Specifications (Profibus DP)

		CDG045D Profibus DP
Baud rates	kBaud MBaud	9.6 / 19.2 / 93.75 / 187.5 / 500 1.5 / 12
Address		Address 00 - 125 by switch or network programmable
Digital functions	read set	Pressure, status, ID Set points, filter, zero adjust, factory reset, DC offset
Connector for Profibus DP		D-sub, 9 pin, female
Connector for CDG (analog output, supply voltage, setpoints)		D-sub, 15 pin, male

Specifications (EtherCAT)

		CDG045D EtherCAT
Protocol		protocol specialized for EtherCAT
Communication Standards		ETG.5003 Part 1 "Semiconductor Device Profile" ETG.5003 Part 2080 "Semiconductor Device Profile" Specific Device Profile: Vacuum Gauge
Node address		Explicit Device Identification
Physical layer		100BASE-Tx-(IEEE 802.3)
Digital functions read		Pressure, status, ID
Digital functions set		Set points, filter, zero adjust, reset, DC offset
Mailbox (CoE)		SDO requests, responses and information
Process data		Fixed PDO mapping and configurable PDO mapping
EtherCAT connector		RJ45, 8-pin (socket), IN and OUT
Cable		Shielded Ethernet CAT5e or higher
Cable length	m (ft.)	<100 (330)

Sky CDG045D 0.05 ...1000 Torr/mbar (continued)

Dimensions

mm (in.)

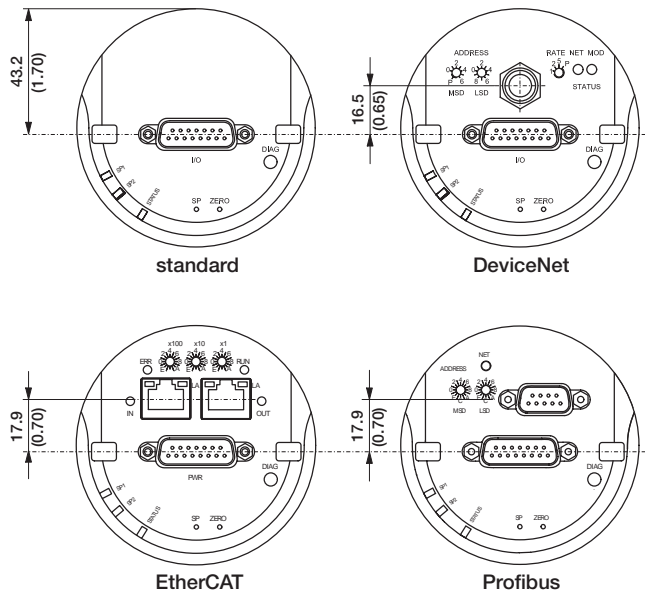
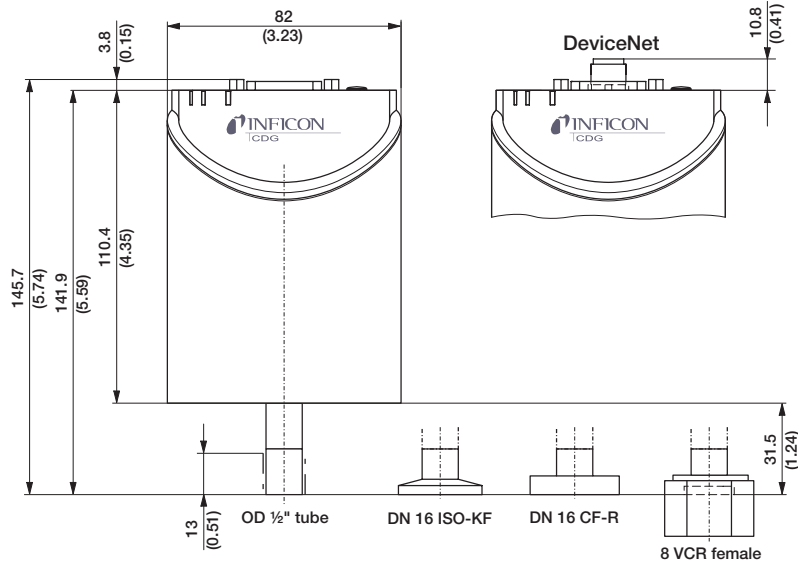

		1/2 in. tube	DN 16 ISO KF	DN 16 CF-R	8 VCR
Internal volume	cm ³ (in. ³)	4.2 (0.26)	4.2 (0.26)	4.2 (0.26)	4.2 (0.26)
Weight	g	837	852	875	897

Capacitance Diaphragm Gauge

Edge CDG045D2 1... 1000Torr/mbar

INFICON Edge Capacitance Diaphragm Gauge is a highly accurate vacuum measurement instrument designed for harsh manufacturing environments. The proven temperature controlled, corrosion resistant, ultra-pure ceramic sensor provides superior span stability over many years paired with state-of-the-art zero stability. Edge comes with the INFICON patented unique sensor shield, which protects the gauge from undesired process by-products. Advanced electronics offer a wide range of configurable signal conditioning for all applications and optional EtherCAT® fieldbus interface. The innovative heating concept enables a cool to the touch surface and saves valuable tool space. INFICON Edge is the smallest vacuum measurement instrument of its kind.



Advantages

- Compact, saves valuable tool space
- Easy integration, EtherCAT, wide variety of full scales and flanges, standard with two set points
- Easy one push button or remote signal zero command, zero offset adjustable
- Diagnostic port for quick service and maintenance
- Two year warranty, longer life time with advanced heating concept and gauge protection.
- No long term recalibration due to excellent signal stability and repeatability, even in harsh plasma applications
- Compliance and standards: CE, EN, UL, SEMI, RoHS

Applications

- CVD, Etch, PVD and other semiconductor production processes

Edge CDG045D2 1... 1000Torr/mbar (continued)

Ordering Information

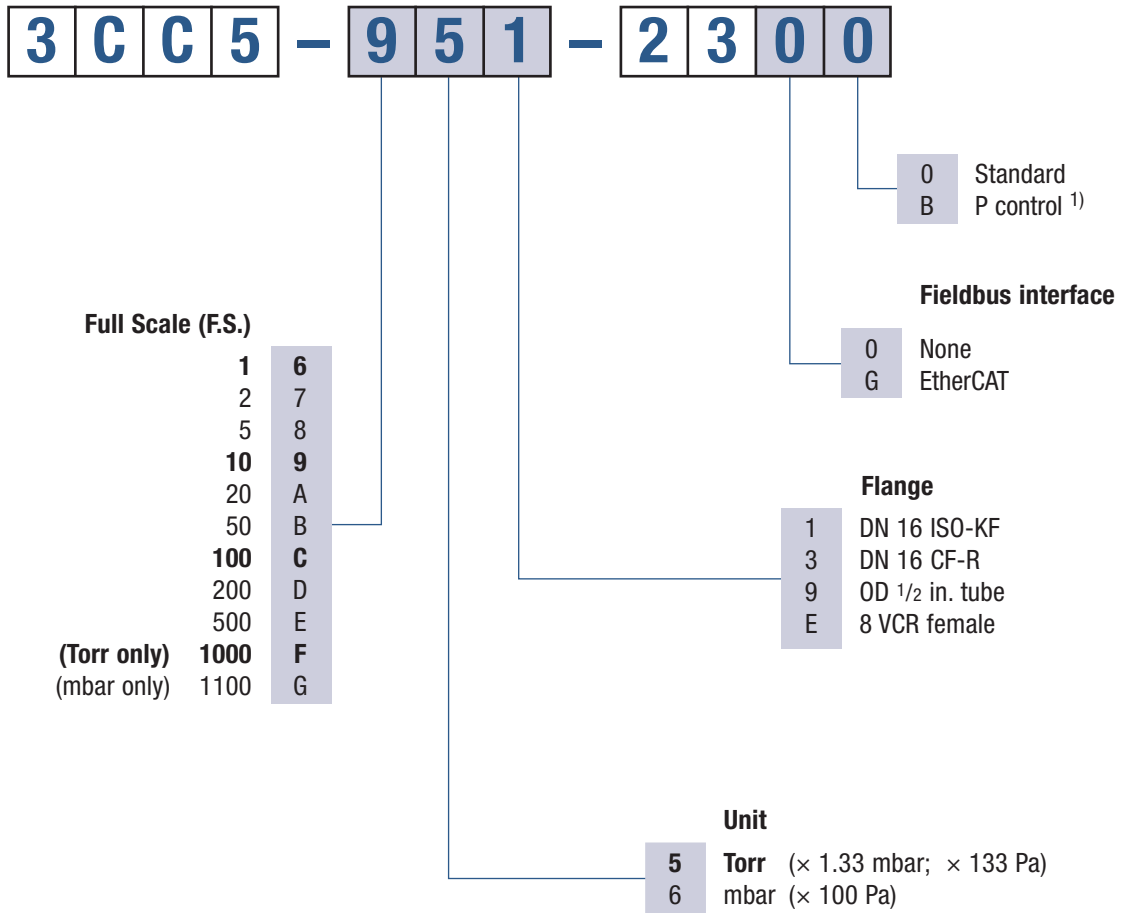

¹⁾ Optimized signal filter setting for pressure control

bold = standard products

Other flange types and full scales (F.S.) on request.

Edge CDG045D2 1... 1000Torr/mbar (continued)

Specifications

Type		1000 Torr, 1100 mbar	500 ... 1 Torr / mbar
Accuracy ¹⁾	% of reading		0.15
Temperature effect			
On zero	% F.S. / °C		0.0025
On span	% of reading / °C		0.01
Pressure, max.	kPa (absolute)	400	260
Resolution	% F.S.		0.003
Lowest reading	% F.S.		0.01
Lowest suggested reading	% F.S.		0.05
Lowest suggested control pressure	% F.S.		0.5
Temperature			
Operation (ambient)	°C		+10 ... +40
Bakeout at flange	°C		≤110
Storage	°C		-20 ... +65
Supply voltage		+14 ... +30 V (dc) or ±15 V (±5%)	
Power consumption			
During Heat up	W		≤12
At operating temperature	W		≤8
Output signal (analog)	V (dc)		0 ... +10
Response time ²⁾	ms		30
Degree of protection			IP 40
Standards			
CE conformity		EMC (EN 61000-6-2, EN 61000-6-3), EN 61010-1 and RoHS	
ETL certification		UL 61010-1, CSA 22.2 No. 61010-1	
SEMI compliance		SEMI S2	
Electrical connection		D-sub, 15 pole, male	
Setpoint			
Number of setpoints			2 (SP1, SP2)
Relay contact	V (dc) / A (dc)		≤30 / ≤0.5
Hysteresis	% F.S.		1
Diagnostic port			
Protocol			RS232-C
Read			Pressure, status, ID
Set			Setpoints, filter, zero adjust, factory reset, DC offset
Materials exposed to vacuum		Aluminum oxide ceramic (Al ₂ O ₃), stainless steel (AISI 316L ⁴⁾)	
Internal volume			
1/2 in. tube	cm ³ (in. ³)		4.2 (0.26)
DN 16 ISO-KF	cm ³ (in. ³)		4.2 (0.26)
DN 16 CF-R	cm ³ (in. ³)		4.2 (0.26)
8 VCR [®] female	cm ³ (in. ³)		4.2 (0.26)
Weight			
1/2 in. tube	g		~837
DN 16 ISO-KF	g		~852
DN 16 CF-R	g		~875
8 VCR female	g		~897

Edge CDG045D2 1... 1000Torr/mbar (continued)

Specifications

Type	1000 Torr, 1100 mbar	500 ... 1 Torr / mbar
EtherCAT		
Protocol EtherCAT		Protocol specialized for EtherCAT
Communication standards		ETG.5003 Part 1, "Semiconductor Device Profile" ETG.5003 Part 2080, "Specific Device Profile: Vacuum Pressure Gauge"
Node address		Explicit Device Identification
Physical layer		100BASE-Tx (IEEE 802.3)
Digital functions read		Pressure, status, ID
Digital functions set		Set points, filter, zero adjust, reset, DC offset
Mailbox (CoE)		SDO requests, responses and information
Process data		Fixed PDO mapping and configurable PDO mapping
EtherCAT connector		RJ45, 8-pin (socket), IN and OUT
Cable		Shielded Ethernet CAT5e or higher
EtherCAT		
Data rate	kbps	100000
EtherCAT		
Cable length	m (ft.)	≤100 (330)

- 1) Non-linearity, hysteresis, repeatability at 25°C ambient operating temperature without temperature effects after two hours operation.
- 2) Increase 10 ... 90% F.S.
- 3) For pressure control type only
- 4) 18% Cr, 10% Ni, 3% Mo, 69% Fe

Dimensions

mm (in.)

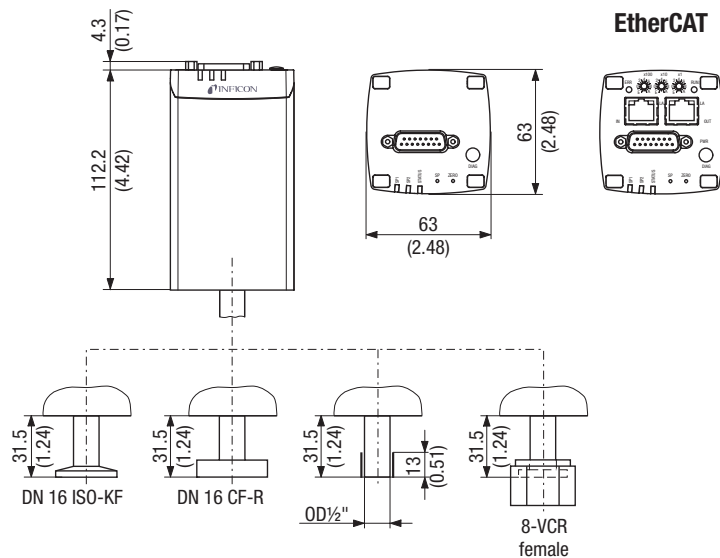

Capacitance Diaphragm Gauge

Stripe CDG045Dhs 0.01 ... 1000Torr/mbar

INFICON Stripe high-speed Capacitance Diaphragm Gauges are the fastest, highly accurate vacuum measurement instruments available. With a less than 2 ms response time combined with the EtherCAT fieldbus interface it opens up a total new field of applications. The proven temperature controlled, corrosion resistant, ultra-pure ceramic sensor provides superior span stability over many years paired with state-of-the-art zero stability. Stripe comes with the INFICON patented unique sensor shield which protects the gauge from undesired process by-products. INFICON Stripe using an innovative heating concept, which provides a cool to the touch surface, and its unique speed capabilities, enabling an unprecedented productivity increase, making it the most advanced vacuum instrument of its kind.

Stripe CDG045Dhs is a proud winner of the prestigious 2014 R&D 100 Award!

Advantages

- High productivity — faster than 2 ms response time (FS > 50 mTorr)
- Flexible integration — EtherCAT fieldbus
- Long lifetime — proven ceramic sensor
- Forget recalibration — 90ppm/year full scale stability

Applications

- Atomic layer deposition
- High speed process control
- PVD, CVD, Etch
- General high temperature vacuum applications



Stripe CDG045Dhs 0.01... 1000Torr/mbar (continued)

Ordering Information

3 C C 9 - **6 5 1** - **2 3 G 0**

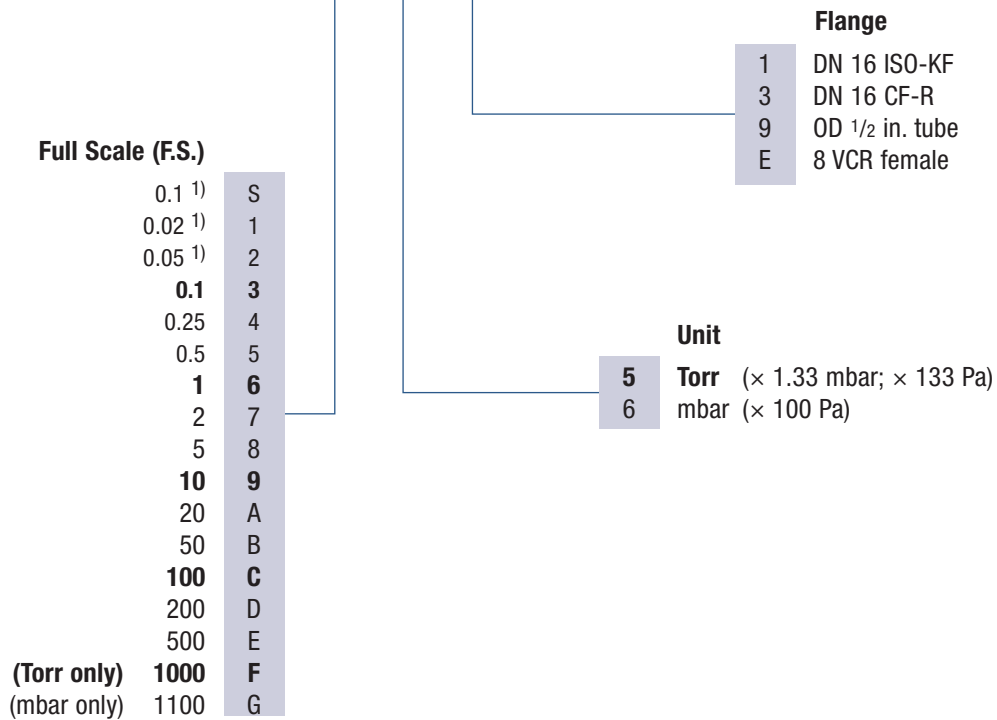

¹ Mounting orientation: vertical

bold = standard products

Other flange types and full scales (F.S.) on request.

Stripe CDG045Dhs 0.01... 1000Torr/mbar (continued)

Specifications

Type		1000Torr / 1100mbar ... 0.5Torr / mbar	0.02 ... 0.01 Torr / mbar
Accuracy ¹⁾	% of reading	0.15	-
Precision	% of reading	-	0.2
Temperature effect			
On zero			
1000 ... 1 Torr/mbar	% F.S. / °C	0.0025	-
0.5 ... 0.05 Torr/mbar	% F.S. / °C	0.0005	-
0.02 ... 0.01 Torr	% F.S. / °C	-	0.01
On span	% of reading / °C		0.01
Pressure, max.			
P max 100Torr/mbar	kPa (absolute)		400
P max 500...1Torr/mbar	kPa (absolute)		260
P max 0.5...0.01Torr/mbar	kPa (absolute)		130
Resolution	% F.S.		0.003
Lowest reading	% F.S.		0.01
Lowest suggested reading	% F.S.		0.05
Lowest suggested control pressure	% F.S.		0.5
Temperature			
Operation (ambient)	°C		+10 ... +40
Bakeout at flange	°C		≤110
Storage	°C		-20 ... +85
Supply voltage			+14 ... +30 V (dc) or ±15 V (±5%)
Power consumption			
During Heat up	W		≤14
At operating temperature	W		≤9
Output signal (analog)	V (dc)		0 ... +10
Response time ²⁾	ms		2
Degree of protection			IP 30
Standards			
CE conformity		EN 61000-6-2, EN 61000-6-3, EN 61010 and RoHS	
ETL certification		UL 61010-1, CSA 22.2 No. 61010-1	
SEMI compliance		SEMI S2	
Electrical connection		D-sub, 15 pole, male	
Setpoint			
Number of setpoints		2 (SP1, SP2)	
Relay contact	V (dc) / A (dc)	≤30 / ≤0.5	
Hysteresis	% F.S.	1	
Diagnostic port			
Protocol		USB	
Read		Pressure, status, ID	
Set		Setpoints, filter, zero adjust, factory reset, DC offset	
Materials exposed to vacuum		Aluminum oxide ceramic (Al ₂ O ₃), stainless steel (AISI 316L)	
Internal volume			
1/2 in. tube	cm ³ (in. ³)	4.2 (0.26)	
DN 16 ISO-KF	cm ³ (in. ³)	4.2 (0.26)	
DN 16 CF-R	cm ³ (in. ³)	4.2 (0.26)	
8 VCR female	cm ³ (in. ³)	4.2 (0.26)	

¹⁾ Non-linearity, hysteresis, repeatability at 25°C ambient operating temperature without temperature effects after 2 hours operation

²⁾ Increase 10 ... 90 % FS

Stripe CDG045Dhs 0.01... 1000Torr/mbar (continued)

Specifications

Type	1000Torr / 1100mbar ... 0.5Torr / mba	0.02 ... 0.01 Torr / mbar
Weight		
1/2 in. tube	g	837
DN 16 ISO-KF	g	852
DN 16 CF-R	g	875
8 VCR female	g	897
EtherCAT		
Protocol EtherCAT	Protocol specialized for EtherCAT	
Communication standards	ETG.5003 Part 1, "Semiconductor Device Profile" ETG.5003 Part 2080, "Specific Device Profile: Vacuum Pressure Gauge"	
Node address	Explicit Device Identification	
Physical layer	100BASE-Tx (IEEE 802.3)	
Digital functions read	Pressure, status, ID	
Digital functions set	Set points, filter, zero adjust, reset, DC offset	
Mailbox (CoE)	SDO requests, responses and information	
Process data	Fixed PDO mapping and configurable PDO mapping	
EtherCAT connector	RJ45, 8-pin (socket), IN and OUT	
Cable	Shielded Ethernet CAT5e or higher	
EtherCAT		
Cable length	m (ft.)	≤100 (330)

Dimensions

mm (in.)

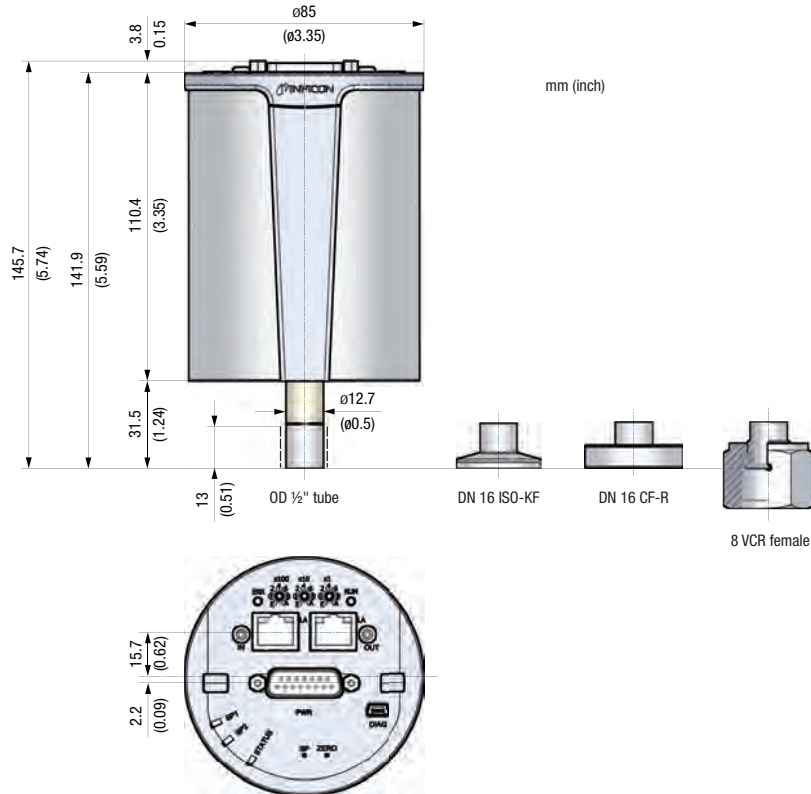

Capacitance Diaphragm Gauge

Cube CDGsci

The high end INFICON Cube Capacitance Diaphragm Instrument is the most accurate ($\leq 0.025\%$ Rd accuracy; ≤ 50 ppm F.S. Repeatability) and most stable vacuum gauge available (< 5 ppm F.S./ $^{\circ}\text{C}$ temperature stability; < 70 ppm F.S./year long term stability). Cube is designed as a pure reference device to standardize vacuum measurement systems and is the only choice for vacuum research applications. The proven INFICON temperature controlled, corrosion resistant ultrapure ceramic sensor is at the heart of Cube's outstanding performance. Cube sets new standards in modern communication and user flexibility with a 20 Bit analog output and RS232-C, TCP/IP and HTML digital output connected through a wireless or wired Ethernet interface. Each device comes with a quality assurance certificate, hand-signed by Cube's leading product researchers. Delivery in a reusable hard shell suit case for storage or shipment to calibration laboratories underlines its professionalism.

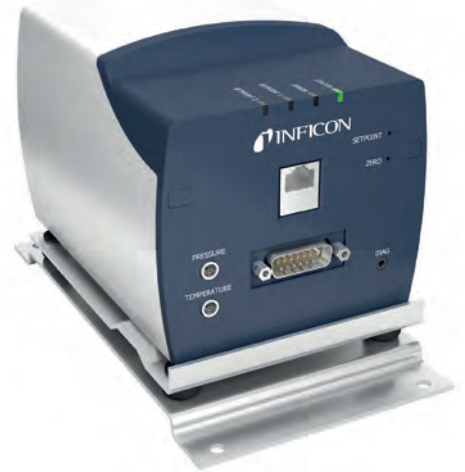

Advantages

- True high precision pressure measurement — ceramic technology
- Full stable output — proven by PTB
- Flexible communication — various modern interfaces
- All functions integrated — no controller required
- Direct mounting to chamber — optimized center of gravity
- Transportation without isolation valve possible

Applications

- Transfer standard
- Main reference gauge
- Research
- In-house standard

Cube CDGsci (continued)

Ordering Information

3 C S 1 - C 1 1 - 2 3 0 0

Full Scale (F.S.)

0.1	3
1	6
10	9
100	C
1000	F

Flange

1	DN 16 ISO-KF
3	DN 16 CF-R
E	8 VCR female

Other flange types and full scale ranges (F.S.) on request.

Cube CDGsci (continued)

Specifications

Type		1000 Torr	100 ... 1 Torr	100 mTorr
Accuracy ¹⁾	% of reading	0.025	0.025	0.05
Temperature effect				
On zero	% F.S. / °C	0.0005	0.0005	0.005
On span	% of reading / °C	0.001	0.001	0.01
Pressure, max.	bar (absolute)	3	2.5	1.5
Lowest reading	% F.S.		0.01	
Lowest suggested reading	% F.S.		0.05	
Temperature				
Operation (ambient)	°C		+10 ... +40	
Storage	°C		-10 ... +50	
Supply voltage			+14 ... +30 V (dc) or ±15 V (±5%)	
Power consumption				
During Heat up	W	≤15	≤15	≤12
At operating temperature	W	≤10	≤10	≤8
Output signal (analog)	V (dc)		0 ... +10	
Response time ²⁾	ms		100	
Degree of protection			IP 40	
Standards		EN 61000-6-2, EN 61000-6-3, EN 61010-1 and RoHS		
CE conformity		UL 61010-1, CSA 22.2 No. 61010-1		
ETL certification		SEMI S2		
SEMI compliance				
Electrical connection		D-sub, 15 pole, male; 2 x LEMO Coax; Ethernet FCC		
Setpoint				
Number of setpoints		2 (SP1, SP2)		
Relay contact	V (dc) / A (dc)	≤30 / ≤0.5		
Hysteresis	% F.S.	1		
Diagnostic port				
Protocol		Web pages, REST services, RS232-ASCII	Web pages, REST services, RS232-ASCII	RS232-C
Read		Pressure, status, ID		
Set		Setpoints, filter, zero adjust, factory reset, DC offset		
Materials exposed to vacuum		Aluminum oxide ceramic (Al ₂ O ₃), stainless steel (AISI 316L ⁴⁾)		
Internal volume				
DN 16 ISO-KF	cm ³ (in. ³)		4.2 (0.26)	
DN 16 CF-R	cm ³ (in. ³)		4.2 (0.26)	
8 VCR female	cm ³ (in. ³)		4.2 (0.26)	
Weight				
DN 16 ISO-KF	g		~1670	
DN 16 CF-R	g		~1670	
8 VCR female	g		~1670	

¹⁾ Non-linearity, hysteresis, repeatability at 25°C ambient operating temperature without temperature effects after two hours operation.

²⁾ Increase 10 ... 90% F.S.

³⁾ For pressure control type only

⁴⁾ 18% Cr, 10% Ni, 3% Mo, 69% Fe

Cube CDGsci (continued)

Dimensions

mm (in.)

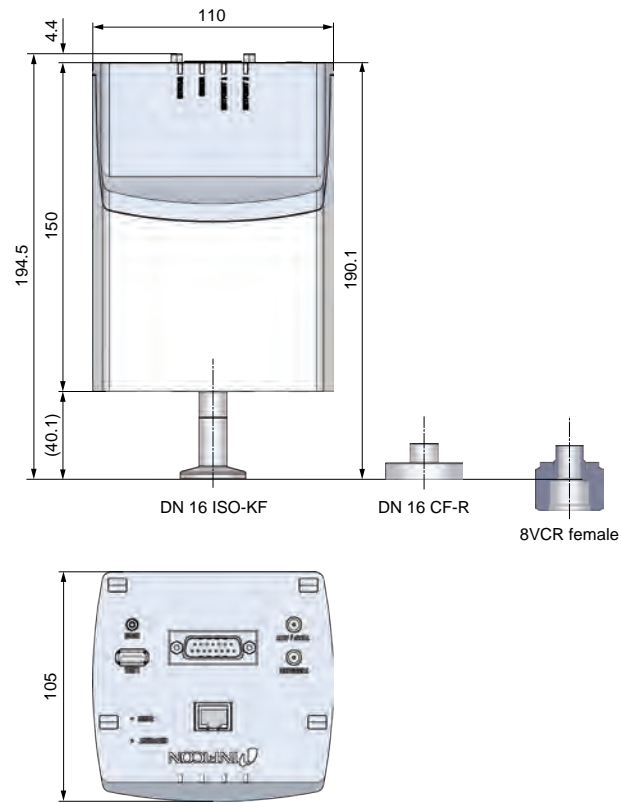

Capacitance Diaphragm Gauges

Sky CDG100D 0.1 ... 1000Torr/mbar

INFICON SKY CDG100D manometers are your best choice for accurate total pressure measurement and control. CDG100D gauges are temperature controlled at 100°C for superior performance in demanding semiconductor and plasma processes. They are available for full scale ranges from 100 mTorr to 1000 Torr, with all common flange types and fieldbus interfaces and provide a linear 0 to 10 V, gas type independent, pressure signal. INFICON capacitance manometers use an ultra pure alumina ceramic diaphragm which is corrosion proof. The advantages of the ceramic sensor are better signal stability, faster recovery from atmosphere, short warm up time and an extraordinary lifetime. INFICON CDG are high quality, cost effective pressure sensors for demanding semiconductor, plasma and vacuum applications.

Advantages

- Lower cost of ownership, 50% faster warm up, energy efficient low power consumption
- Easy integration, wide variety of full scales, flanges and interfaces, standard with two set points
- Easy one push button or remote signal zero command, zero offset adjustable
- Diagnostic port for quick service and maintenance
- Two year warranty, longer lifetime with advanced heating concept and gauge protection
- No long term recalibration due to excellent signal stability and repeatability, even in harsh plasma applications
- Compliance and standards: CE, EN, UL, SEMI, RoHS

Applications

- Etch, PVD, CVD and other semiconductor production processes
- Chemical and corrosive high temperature processes
- General thin film and vacuum processes requiring gauge protection



Sky CDG100D (continued)

Ordering Information

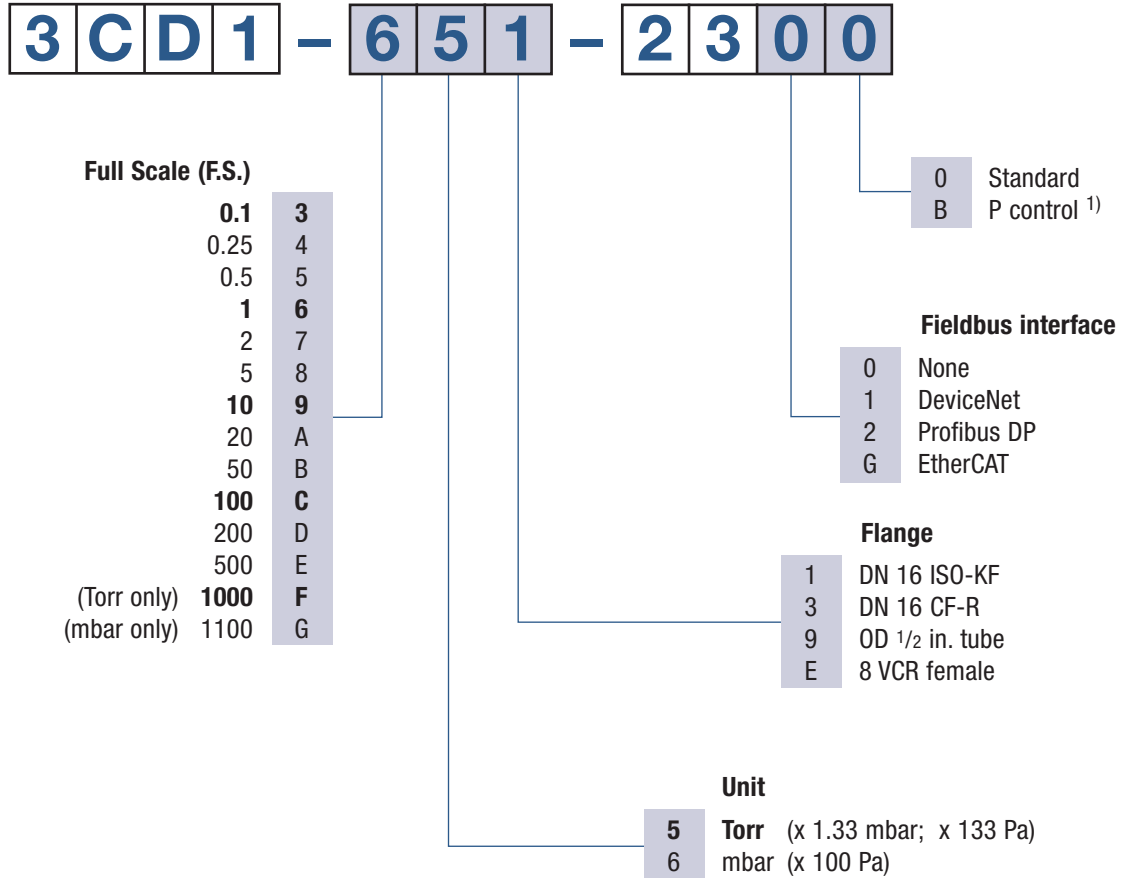

¹⁾ Optimized signal filter setting for pressure control

bold = standard products

Other flange types and full scale ranges (F.S.) on request.

Accessories

	Diagnostic
Communication adapter (2 m) for PC RS232 serial port	303-333

Software to run the diagnostic functions on Windows NT, XP can be downloaded from our website.

Sky CDG100D (continued)

Specifications (Torr based standard products)

Measurement Range F.S. (Full Scale)	Torr Pa mbar	1000 133,322 1333	100 13,332 133	10 1,333 13.3	1 133 1.3	0.1 13 0.13
Accuracy ¹⁾	% of reading			0.2		0.4
Temperature effect						
on zero	% F.S. / °C			0.0025		0.005
on span	% of reading / °C			0.02		
Pressure, max.	kPa (absolute)	400		260		130
Resolution	% F.S.			0.003		
Lowest reading	% F.S.			0.01		
Lowest suggested reading	% F.S.			0.05		
Lowest suggested control pressure	% F.S.			0.5		
Temperature						
Operation (ambient) ⁵⁾	°C			+10 ... +50		
Bakeout at flange	°C			≤110		
Storage	°C			-20 ... +65		
Supply voltage				+14 ... +30 V (dc) or ±15 V (±5%)		
Power consumption						
During Heat up	W			≤15		
At operating temperature	W			≤10		
Output signal (analog)	V (dc)			0 ... +10		
Response time ²⁾	ms			30		130 / 30 ³⁾
Degree of protection				IP 40		
Standards		EN 61000-6-2, EN 61000-6-3, EN 61010, UL 61010-1, CSA 22.2 No.61010-1, SEMI S-2				
Electrical connection				D-sub, 15 pole, male		
Setpoint				Two setpoints (SP1, SP2)		
Relay contact	V (dc) / A (dc)			≤30 / ≤0.5		
Hysteresis	% F.S.			1		
Diagnostic port						
Protocol				RS232-C		
Read				Pressure, status, ID,		
Set				Set points, filter, zero adjust, factory reset, DC offset		
Materials exposed to vacuum		Aluminum oxide ceramic (Al ₂ O ₃), stainless steel (AISI 316L ⁴⁾)				

¹⁾ Non-linearity, hysteresis, repeatability at 25°C ambient operating temperature without temperature effects after two hours operation.

²⁾ Increase 10 ... 90% F.S.

³⁾ For pressure control type only

⁴⁾ 18% Cr, 10% Ni, 3% Mo, 69% Fe

⁵⁾ Ambient temperatures >40°C may increase surface temperature above SEMI S2 compliance levels — mark “caution hot!”

Sky CDG100D (continued)

Specifications (Torr based other ranges)

Measurement Range F.S. (Full Scale)	Torr Pa mbar	500 66,661 666.61	200 26,664 267	50 6,666.1 66.67	20 2,666 26.7	5 666.61 6.6661	2 266.66 2.67	0.5 66.66 0.67	0.25 33.3 0.33	
Accuracy ¹⁾	% of reading	0.2						0.4		
Temperature effect										
on zero	% F.S. / °C	0.0025						0.005		
on span	% of reading / °C	0.02								
Pressure, max.	kPa (absolute)	400			260			130		
Response time ²⁾	ms	30						130		

¹⁾ Non-linearity, hysteresis, repeatability at 25°C ambient operating temperature without temperature effects after two hours operation.

²⁾ Increase 10 ... 90% F.S.

Further specifications see table above.

Specifications (mbar based products)

Measurement Range F.S. (Full Scale)	mbar Pa	1100 110,000	100 10,000	10 1,000	1 100	0.1 10	
Accuracy ¹⁾	% of reading	0.2				0.4	
Temperature effect							
on zero	% F.S. / °C	0.0025				0.005	
on span	% of reading / °C	0.02					
Pressure, max.	kPa (absolute)	400		260		130	
Response time ²⁾	ms	30				130 / 30 ³⁾	

¹⁾ Non-linearity, hysteresis, repeatability at 25°C ambient operating temperature without temperature effects after two hours operation.

²⁾ Increase 10 ... 90% F.S.

³⁾ For pressure control type only

Further specifications see table «SPECIFICATIONS (Torr based standard products)».

Sky CDG100D (continued)

Specifications (DeviceNet)

		CDG100D DeviceNet
Protocol		DeviceNet, group 2 slave only
Data rate	kBaud	125, 250, 500 by switch or network programmable
Cable length		
125 kbps	m (ft.)	500 (1650)
250 kbps	m (ft.)	250 (825)
500 kbps	m (ft.)	100 (330)
MAC ID		Address 00 - 63 by switch or network programmable
Digital functions	read	Pressure, status, ID
	set	Set points, filter, zero adjust, factory reset, DC offset
Specification		DeviceNet "Vacuum Gauge Device Profile" (ODVA)
Device type		"VG" vacuum gauge
I/O slave messaging		Polling only
Supply voltage for gauge at D-sub connector		+14 ... +30 V (dc) or ± 15 V / ≤ 12 W
Supply voltage for DeviceNet transceiver at microstyle connector		24 V nom / < 2 W (11 ... 25 V)
Connector for DeviceNet		Microstyle, 5 pin, male
Connector for CDG (analog output, supply voltage CDG, setpoints)		D-sub, 15 pin, male

Specifications (Profibus DP)

		CDG100D Profibus DP
Baud rates	kBaud	9.6 / 19.2 / 93.75 / 187.5 / 500
	MBaud	1.5 / 12
Address		Address 00 - 125 by switch or network programmable
Digital functions	read	Pressure, status, ID
	set	Set points, filter, zero adjust, factory reset, DC offset
Connector for Profibus DP		D-sub, 9 pin, female
Connector for CDG (analog output, supply voltage, setpoints)		D-sub, 15 pin, male

Specifications (EtherCAT)

		CDG100D EtherCAT
Protocol		protocol specialized for EtherCAT
Communication Standards		ETG.5003 Part 1 "Semiconductor Device Profile" ETG.5003 Part 2080 "Semiconductor Device Profile" Specific Device Profile: Vacuum Gauge
Node address		Explicit Device Identification
Physical layer		100BASE-Tx-(IEEE 802.3)
Digital functions read		Pressure, status, ID
Digital functions set		Set points, filter, zero adjust, reset, DC offset
Mailbox (CoE)		SDO requests, responses and information
Process data		Fixed PDO mapping and configurable PDO mapping
EtherCAT connector		RJ45, 8-pin (socket), IN and OUT
Cable		Shielded Ethernet CAT5e or higher
Cable length	m (ft.)	< 100 (330)

Sky CDG100D (continued)

Dimensions

mm (in.)

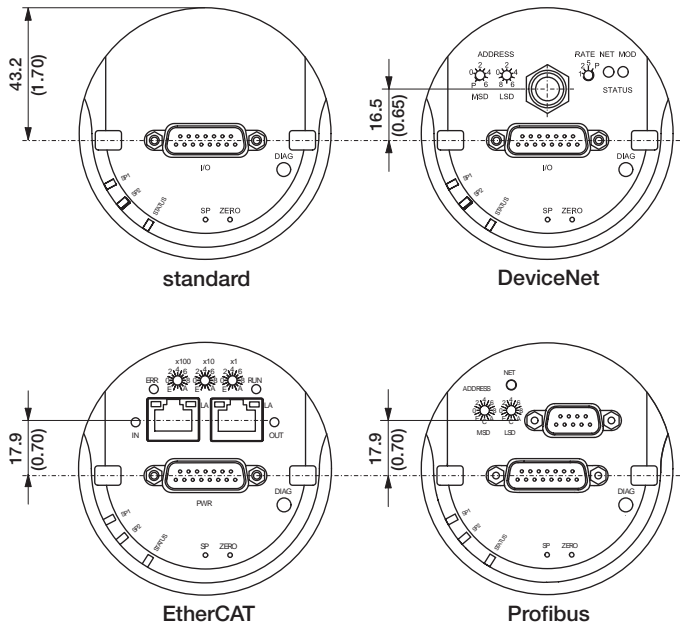
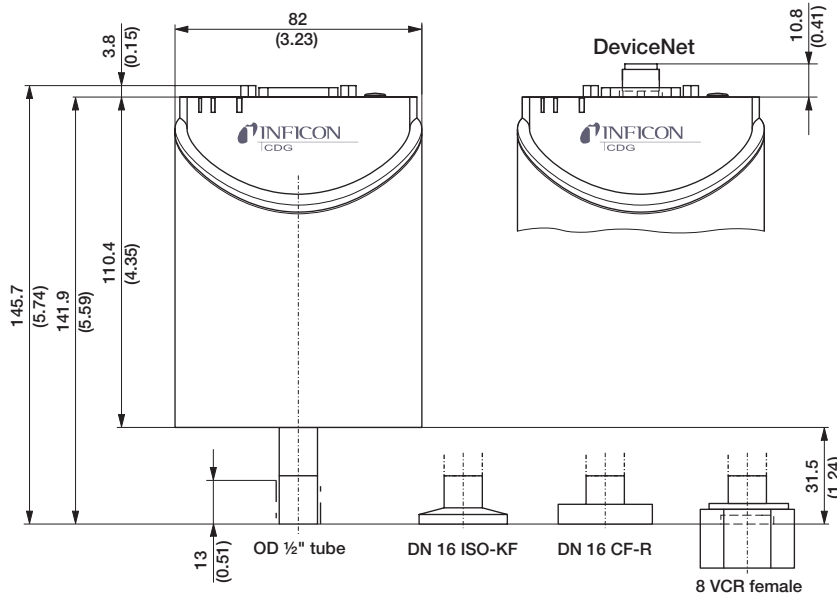

		1/2 in. tube	DN 16 ISO KF	DN 16 CF-R	8 VCR
Internal volume	cm ³ (in. ³)	4.2 (0.26)	4.2 (0.26)	4.2 (0.26)	4.2 (0.26)
Weight	g	837	852	875	897

Capacitance Diaphragm Gauge

Edge CDG100D2 1... 1000Torr/mbar

INFICON Edge Capacitance Diaphragm Gauge is a highly accurate vacuum measurement instrument designed for harsh manufacturing environments. The proven temperature controlled, corrosion resistant, ultra-pure ceramic sensor provides superior span stability over many years paired with state-of-the-art zero stability. Edge comes with the INFICON patented unique sensor shield which protects the gauge from undesired process by-products. Advanced electronics offer a wide range of configurable signal conditioning for all applications and optional EtherCAT fieldbus interface. The innovative heating concept enables a cool to the touch surface and saves valuable tool space. INFICON Edge is the smallest vacuum measurement instrument of its kind.



Advantages

- Compact, saves valuable tool space
- Easy integration, EtherCAT, wide variety of full scales and flanges, standard with two set points
- Easy one push button or remote signal zero command, zero offset adjustable
- Diagnostic port for quick service and maintenance
- Two year warranty, longer life time with advanced heating concept and gauge protection.
- No long term recalibration due to excellent signal stability and repeatability, even in harsh plasma applications
- Compliance and standards: CE, EN, UL, SEMI, RoHS

Applications

- CVD, Etch, PVD and other semiconductor production processes

Edge CDG100D2 1... 1000Torr/mbar (continued)

Ordering Information

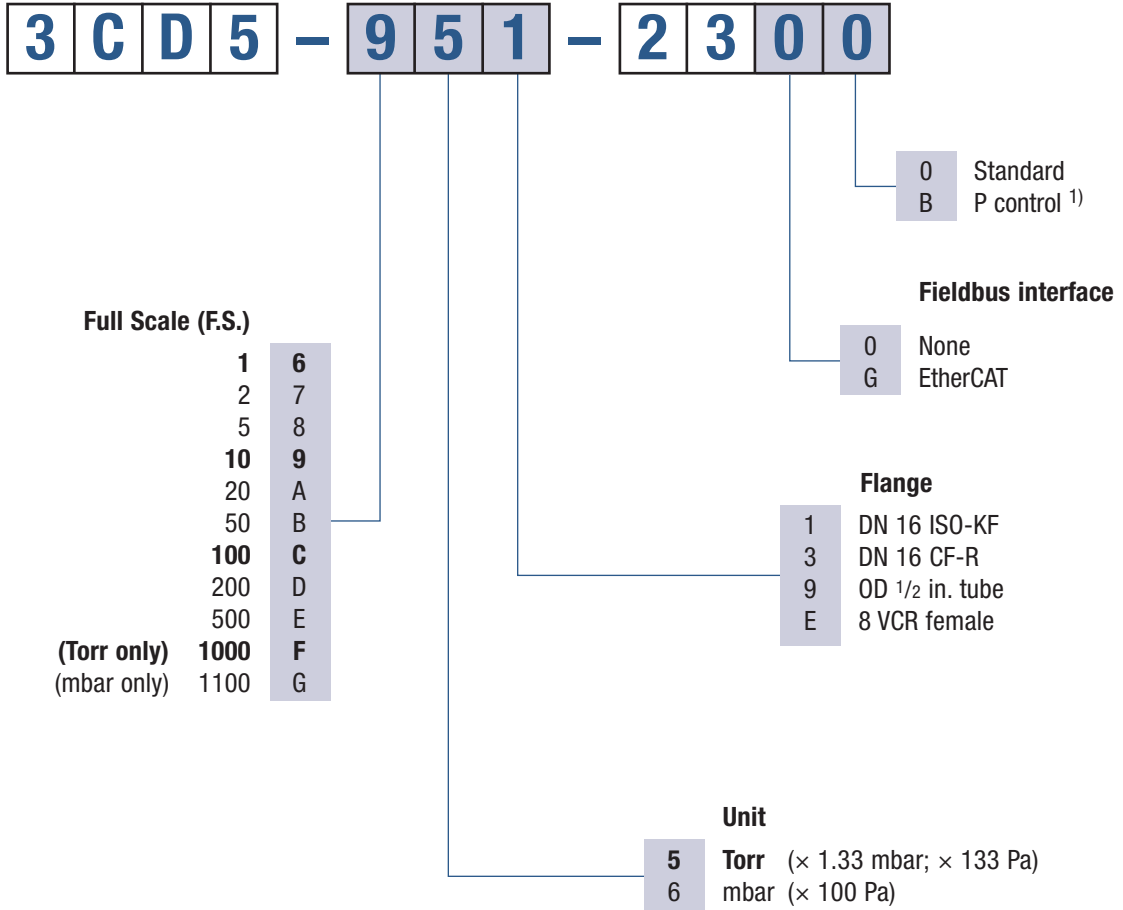

¹⁾ Optimized signal filter setting for pressure control

bold = standard products

Other flange types and full scales (F.S.) on request.

Edge CDG100D2 1... 1000Torr/mbar (continued)

Specifications

Type		1000 ... 500 Torr / mbar	200 ... 1 Torr / mbar
Accuracy ¹⁾	% of reading	0.15	
Temperature effect			
On zero	% F.S. / °C	0.0025	
On span	% of reading / °C	0.02	
Pressure, max.	kPa (absolute)	400	260
Resolution	% F.S.	0.003	
Lowest reading	% F.S.	0.01	
Lowest suggested reading	% F.S.	0.05	
Lowest suggested control pressure	% F.S.	0.5	
Temperature			
Operation (ambient) ⁵⁾	°C	+10 ... +50 ⁵⁾	+10 ... +50
Bakeout at flange	°C	≤110	
Storage	°C	-20 ... +65	-20 ... +65
Supply voltage		+14 ... +30 V (dc) or ±15 V (±5%)	
Power consumption			
During Heat up	W	≤20	
At operating temperature	W	≤14	
Output signal (analog)	V (dc)	0 ... +10	
Response time ²⁾	ms	30	
Degree of protection		IP 40	
Standards			
CE conformity		EN 61000-6-2, EN 61000-6-3, EN 61010-1 and RoHS	
ETL certification		UL 61010-1, CSA 22.2 No. 61010-1	
SEMI compliance		SEMI S2 ⁵⁾	SEMI S2
Electrical connection		D-sub, 15 pole, male	
Setpoint			
Number of setpoints		2 (SP1, SP2)	
Relay contact	V (dc) / A (dc)	≤30 / ≤0.5	
Hysteresis	% F.S.	1	
Diagnostic port			
Protocol		RS232-C	
Read		Pressure, status, ID	
Set		Setpoints, filter, zero adjust, factory reset, DC offset	
Materials exposed to vacuum		Aluminum oxide ceramic (Al ₂ O ₃), stainless steel (AISI 316L ⁴⁾)	
Internal volume			
1/2 in. tube	cm ³ (in. ³)	4.2 (0.26)	
DN 16 ISO-KF	cm ³ (in. ³)	4.2 (0.26)	
DN 16 CF-R	cm ³ (in. ³)	4.2 (0.26)	
8 VCR female	cm ³ (in. ³)	4.2 (0.26)	
Weight			
1/2 in. tube	g	~837	
DN 16 ISO-KF	g	~852	
DN 16 CF-R	g	~875	
8 VCR female	g	~897	

Edge CDG100D2 1... 1000Torr/mbar (continued)

Specifications

Type	1000 ... 500 Torr/mbar	200 ... 1 Torr / mbar
EtherCAT		
Protocol EtherCAT		Protocol specialized for EtherCAT
Communication standards		ETG.5003 Part 1, "Semiconductor Device Profile" ETG.5003 Part 2080, "Specific Device Profile: Vacuum Pressure Gauge"
Node address		Explicit Device Identification
Physical layer		100BASE-Tx (IEEE 802.3)
Digital functions read		Pressure, status, ID
Digital functions set		Set points, filter, zero adjust, reset, DC offset
Mailbox (CoE)		SDO requests, responses and information
Process data		Fixed PDO mapping and configurable PDO mapping
EtherCAT connector		RJ45, 8-pin (socket), IN and OUT
Cable		Shielded Ethernet CAT5e or higher
Connector for CDG (analog output, supply voltage, setpoints)		D-sub. 15 pin, male
EtherCAT		
Data rate	kbps	100000
EtherCAT		
Cable length	m (ft.)	≤100 (330)

- 1) Non-linearity, hysteresis, repeatability at 25°C ambient operating temperature without temperature effects after two hours operation.
- 2) Increase 10 ... 90% F.S.
- 3) For pressure control type only
- 4) 18% Cr, 10% Ni, 3% Mo, 69% Fe
- 5) Ambient temperatures >40°C may increase surface temperature above SEMI S2 compliance levels — mark "caution hot!"

Dimensions

mm (in.)

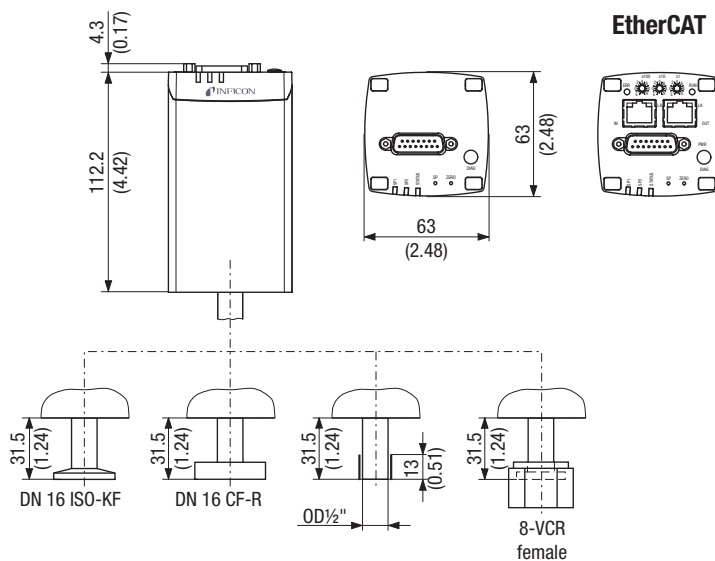

Capacitance Diaphragm Gauge

Stripe CDG100Dhs 0.1 ... 1000Torr/mbar

INFICON Stripe high-speed Capacitance Diaphragm Gauges are the fastest, highly accurate vacuum measurement instruments available. With a less than 2 ms response time combined with the EtherCAT fieldbus interface it opens up a total new field of applications. The proven temperature controlled, corrosion resistant, ultra-pure ceramic sensor provides superior span stability over many years paired with state-of-the-art zero stability. Stripe comes with the INFICON patented unique sensor shield which protects the gauge from undesired process by-products. INFICON Stripe using an innovative heating concept, which provides a cool to the touch surface, and its unique speed capabilities, enabling an unprecedented productivity increase, making it the most advanced vacuum instrument of its kind.



Advantages

- High productivity — faster than 2 ms response time
- Flexible integration — EtherCAT fieldbus
- Long lifetime — proven ceramic sensor
- Forget recalibration — 90ppm / year full scale stability

Applications

- Atomic layer deposition
- High speed process control
- PVD, CVD, Etch
- General high temperature vacuum applications

Stripe CDG100Dhs 0.1... 1000Torr/mbar (continued)

Ordering Information



Full Scale (F.S.)				Flange
0.1	3			1 DN 16 ISO-KF
0.25	4			3 DN 16 CF-R
0.5	5			9 OD 1/2 in. tube
1	6			E 8 VCR female
2	7			
5	8			
10	9			
20	A			Unit
50	B			5 Torr (× 1.33 mbar; × 133 Pa)
100	C			6 mbar (× 100 Pa)
200	D			
500	E			
(Torr only) 1000	F			
(mbar only) 1100	G			

bold = standard products

Other flange types and full scales (F.S.) on request.

Stripe CDG100Dhs 0.1... 1000Torr/mbar (continued)

Specifications

Type		1000 ... 500 Torr / mbar	200 ... 1 Torr / mbar	0.5 ... 0.1 Torr / mbar
Accuracy	% of reading	0.2	0.2	0.4
Temperature effect				
On zero	% F.S. / °C	0.0025	0.0025	0.005
On span	% of reading / °C		0.02	
Pressure, max.	kPa (absolute)	400	260	130
Resolution	% F.S.		0.003	
Lowest reading	% F.S.		0.01	
Lowest suggested reading	% F.S.		0.05	
Lowest suggested control pressure	% F.S.		0.5	
Temperature				
Operation (ambient)	°C		+10 ... +50	
Bakeout at flange	°C		≤110	
Storage	°C		-20 ... +85	
Supply voltage			+14 ... +30 V (dc) or ±15 V (±5%)	
Power consumption				
During Heat up	W		≤16	
At operating temperature	W		≤11	
Output signal (analog)	V (dc)		0 ... +10	
Response time	ms		2	
Degree of protection			IP 30	
Standards				
CE conformity		EN 61000-6-2, EN 61000-6-3, EN 61010-1 and RoHS		
ETL certification		UL 61010-1, CSA 22.2 No. 61010-1		
SEMI compliance		SEMI S2		
Electrical connection			D-sub, 15 pole, male	
Setpoint				
Number of setpoints			2 (SP1, SP2)	
Relay contact	V (dc) / A (dc)		≤30 / ≤0.5	
Hysteresis	% F.S.		1	
Diagnostic port				
Protocol			USB	
Read			Pressure, status, ID	
Set			Setpoints, filter, zero adjust, factory reset, DC offset	
Materials exposed to vacuum			Aluminum oxide ceramic (Al ₂ O ₃), stainless steel (AISI 316L)	
Internal volume				
1/2 in. tube	cm ³ (in. ³)		4.2 (0.26)	
DN 16 ISO-KF	cm ³ (in. ³)		4.2 (0.26)	
DN 16 CF-R	cm ³ (in. ³)		4.2 (0.26)	
8 VCR female	cm ³ (in. ³)		4.2 (0.26)	
Weight				
1/2 in. tube	g		~837	
DN 16 ISO-KF	g		~852	
DN 16 CF-R	g		~875	
8 VCR female	g		~897	

Stripe CDG100Dhs 0.1... 1000Torr/mbar (continued)

Specifications

Type	1000 ... 500 Torr / mbar	200 ... 1 Torr / mbar	0.5 ... 0.1 Torr / mbar
EtherCAT			
Protocol EtherCAT		Protocol specialized for EtherCAT	
Communication standards		ETG.5003 Part 1, "Semiconductor Device Profile" ETG.5003 Part 2080, "Specific Device Profile: Vacuum Pressure Gauge"	
Node address		Explicit Device Identification	
Physical layer		100BASE-Tx (IEEE 802.3)	
Digital functions read		Pressure, status, ID	
Digital functions set		Set points, filter, zero adjust, reset, DC offset	
Mailbox (CoE)		SDO requests, responses and information	
Process data		Fixed PDO mapping and configurable PDO mapping	
EtherCAT connector		RJ45, 8-pin (socket), IN and OUT	
Cable		Shielded Ethernet CAT5e or higher	
EtherCAT			
Cable length	m (ft.)	≤100 (330)	

Dimensions

mm (in.)

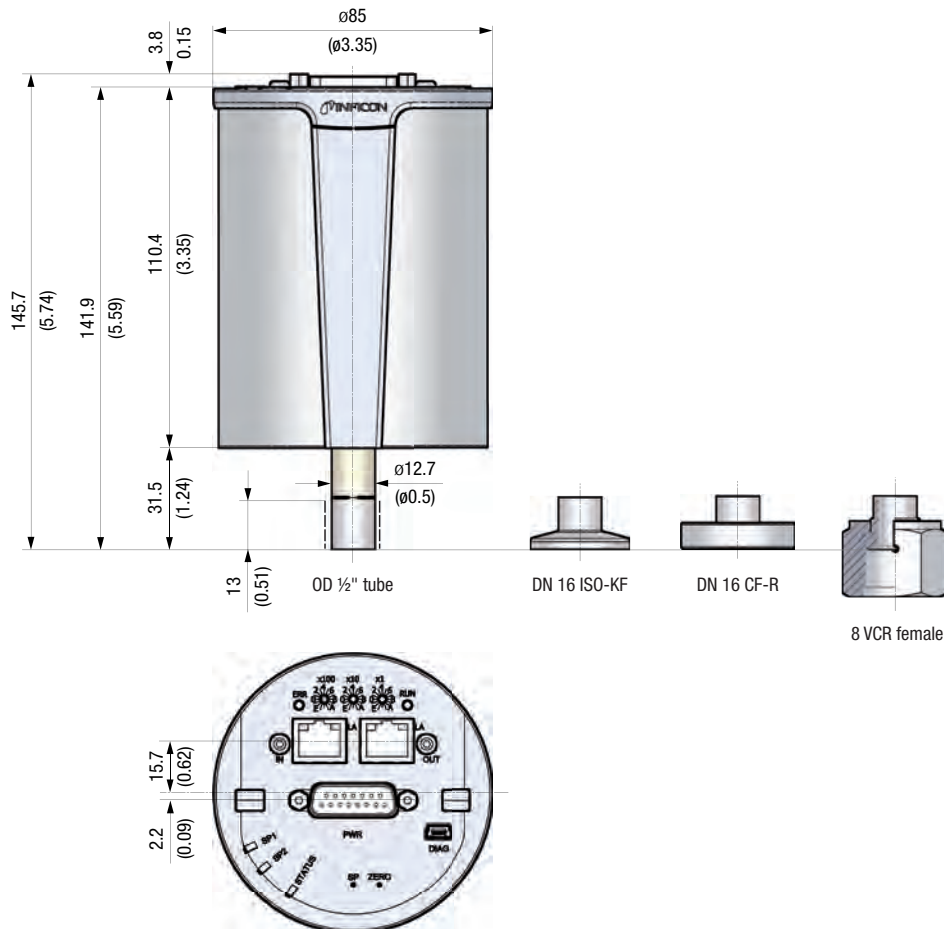

Capacitance Diaphragm Gauges

Sky CDG160D, CDG200D 1 ... 1000 Torr/mbar

INFICON SKY CDG160D and CDG200D high temperature manometers are your best choice for accurate total pressure measurement and control. CDG160D and CDG200D gauges are temperature controlled at 160°C respectively 200°C for superior performance in demanding semiconductor and plasma processes. They are available for full scale ranges from 1 Torr to 1000 Torr, with all common flange types and fieldbus interfaces and provide a linear 0 to 10V, gas type independent, pressure signal. INFICON capacitance manometers use an ultra pure alumina ceramic diaphragm which is corrosion proof. The advantages of the ceramic sensor are better signal stability, faster recovery from atmosphere, short warm up time and an extraordinary lifetime. INFICON CDGs are high quality, cost effective pressure sensors for demanding semiconductor, plasma and vacuum applications.



Advantages

- Lower cost of ownership, 50% faster warm up, energy efficient low power consumption
- Easy integration, wide variety of full scales, flanges and interfaces, standard with two set points
- Easy one push button or remote signal zero command, zero offset adjustable
- Diagnostic port for quick service and maintenance
- Two year warranty, longer lifetime with  heating concept and gauge protection
- No long term recalibration due to excellent signal stability and repeatability, even in harsh plasma applications
- Compliance and standards: CE, EN, UL, SEMI, RoHS

Applications

- Etch, CVD, PVD and other semiconductor production processes
- Chemical and corrosive high temperature processes
- General thin film and vacuum processes requiring gauge protection

Sky CDG160D, CDG200D 1 ... 1000 Torr/mbar (continued)

Ordering Information

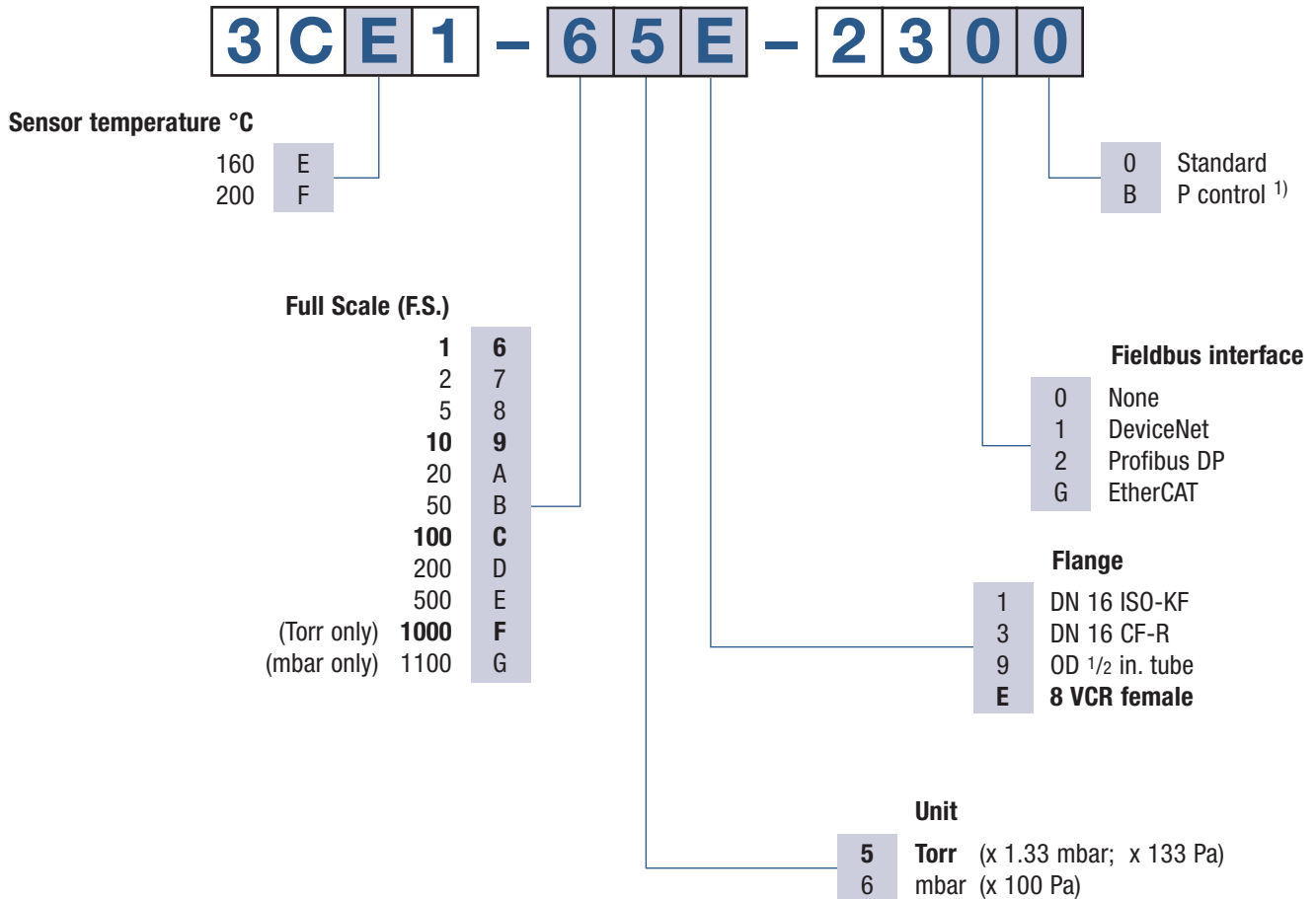

¹⁾ Optimized signal filter setting for pressure control

bold = standard products

Other flange types and full scale ranges (F.S.) on request.

Accessories

	Diagnostic
Communication adapter (2 m) for PC RS232 serial port	303-333

Software to run the diagnostic functions on Windows NT, XP can be downloaded from our website.

Sky CDG160D, CDG200D 1 ... 1000 Torr/mbar (continued)

Specifications (Torr based standard products)

Measurement Range F.S. (Full Scale)	Torr Pa mbar	1000 133,322 1333	100 13,332 133	10 1,333 13.3	1 133 1.3
Accuracy ¹⁾	% of reading				0.4
Temperature effect					
on zero	% F.S. / °C				0.005
on span	% of reading / °C				0.02
Pressure, max.	kPa (absolute)	400			260
Resolution	% F.S.				0.003
Lowest reading	% F.S.				0.01
Lowest suggested reading	% F.S.				0.05
Lowest suggested control pressure	% F.S.				0.5
Temperature					
Operation (ambient) ⁴⁾	°C				+10 ... +50
Bakeout at flange	°C				≤200
Storage	°C				-20 ... +65
Supply voltage					+21 ... +30 V (dc) or ±15 V (±5%)
Power consumption during heat up					
CDG160D	W				≤18
CDG200D	W				≤25
Power consumption at operating temperature					
CDG160D	W				≤12
CDG200D	W				≤18
Output signal (analog)	V (dc)				0 ... +10
Response time ²⁾	ms				30
Degree of protection					IP 40
Standards					EN 61000-6-2, EN 61000-6-3, EN 61010, UL 61010-1, CSA 22.2 No.61010-1, SEMI S-2
Electrical connection					D-Sub, 15-pin, male
Setpoint					Two setpoints (SP1, SP2)
Relay contact	V (dc) / A (dc)				≤30 / ≤0.5
Hysteresis	% F.S.				1
Diagnostic port					
Protocol					RS232-C
Read					Pressure, status, ID,
Set					Set points, filter, zero adjust, factory reset, DC offset
Materials exposed to vacuum					Aluminum oxide ceramic (Al ₂ O ₃), stainless steel (AISI 316L ³⁾)

¹⁾ Non-linearity, hysteresis, repeatability at 25°C ambient operating temperature without temperature effects after two hours operation.

²⁾ Increase 10 ... 90% F.S.

³⁾ 18% Cr, 10% Ni, 3% Mo, 69% Fe

⁴⁾ Ambient temperatures >40°C may increase surface temperature above SEMI S2 compliance levels — mark “caution hot!”

Sky CDG160D, CDG200D 1 ... 1000 Torr/mbar (continued)

Specifications (Torr based other ranges)

Measurement Range F.S. (Full Scale)	Torr Pa mbar	500 66,661 666.61	200 26,664 267	50 6,666.1 66.67	20 2,666 26.7	5 666.61 6.6661	2 266.66 2.67
Accuracy ¹⁾	% of reading	0.4					
Temperature effect on zero	% F.S. / °C	0.005					
on span	% of reading / °C	0.02					
Pressure, max.	kPa (absolute)	400		260			
Resolution	% F.S.	0.003					

¹⁾ Non-linearity, hysteresis, repeatability at 25°C ambient operating temperature without temperature effects after two hours operation.

Further specifications see table above.

Specifications (mbar based products)

Measurement Range F.S. (Full Scale)	mbar Pa	1100 110,000	100 10,000	10 1,000	1 100
Accuracy ¹⁾	% of reading	0.4			
Temperature effect on zero	% F.S. / °C	0.005			
on span	% of reading / °C	0.02			
Pressure, max.	kPa (absolute)	400		260	
Resolution	% F.S.	0.003			

¹⁾ Non-linearity, hysteresis, repeatability at 25°C ambient operating temperature without temperature effects after two hours operation.

Further specifications see table «SPECIFICATIONS (Torr based standard products)».

Specifications (DeviceNet)

		CDG160D, CDG200D DeviceNet
Protocol		DeviceNet, group 2 slave only
Data rate	kBaud	125, 250, 500 by switch or network programmable
Cable length		
125 kbps	m (ft.)	500 (1650)
250 kbps	m (ft.)	250 (825)
500 kbps	m (ft.)	100 (330)
MAC ID		Address 00 - 63 by switch or network programmable
Digital functions	read set	Pressure, status, ID Set points, filter, zero adjust, factory reset, DC offset
Specification		DeviceNet "Vacuum Gauge Device Profile" (ODVA)
Device type		"VG" vacuum gauge
I/O slave messaging		Polling only
Supply voltage for gauge at D-sub connector		+14 ... +30 V (dc) or ±15 V / ≤12 W
Supply voltage for DeviceNet transceiver at microstyle connector		24 V nom / <2 W (11 ... 25 V)
Connector for DeviceNet		Microstyle, 5-pin, male
Connector for CDG (analog output, supply voltage CDG, setpoints)		D-Sub, 15-pin, male

Sky CDG160D, CDG200D 1 ... 1000 Torr/mbar (continued)

Specifications (Profibus DP)

		CDG160D, CDG200D Profibus DP
Baud rates	kBaud	9.6 / 19.2 / 93.75 / 187.5 / 500
	MBaud	1.5 / 12
Address		Address 00 - 125 by switch or network programmable
Digital functions	read	Pressure, status, ID
	set	Set points, filter, zero adjust, factory reset, DC offset
Connector for Profibus DP		D-Sub, 9-pin, female
Connector for CDG (analog output, supply voltage, setpoints)		D-Sub, 15-pin, male

Specifications (EtherCAT)

		CDG160D, CDG200D EtherCAT
Protocol		protocol specialized for EtherCAT
Communication Standards		ETG.5003 Part 1 "Semiconductor Device Profile"
		ETG.5003 Part 2080 "Semiconductor Device Profile"
		Specific Device Profile: Vacuum Gauge
Node address		Explicit Device Identification
Physical layer		100BASE-Tx-(IEEE 802.3)
Digital functions read		Pressure, status, ID
Digital functions set		Set points, filter, zero adjust, reset, DC offset
Mailbox (CoE)		SDO requests, responses and information
Process data		Fixed PDO mapping and configurable PDO mapping
EtherCAT connector		RJ45, 8-pin (socket), IN and OUT
Cable		Shielded Ethernet CAT5e or higher
Cable length	m (ft.)	<100 (330)

Sky CDG160D, CDG200D 1 ... 1000 Torr/mbar (continued)

Dimensions, Internal Volume, Weight

mm (in.)

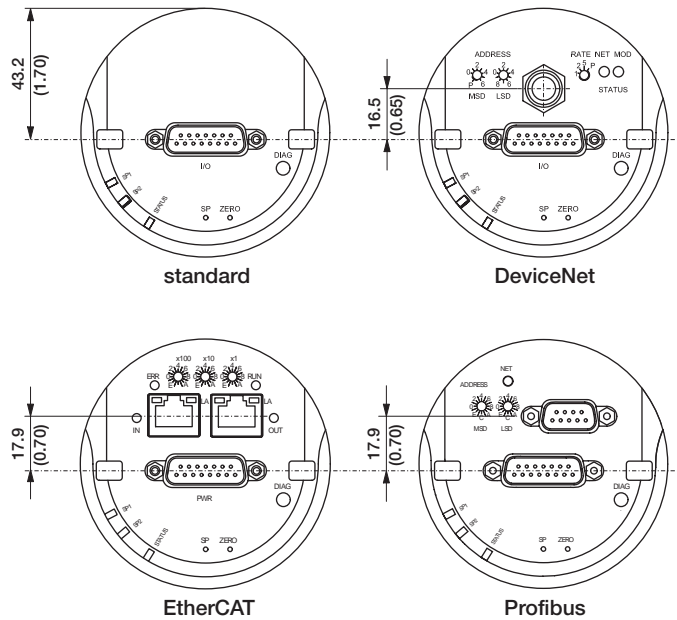
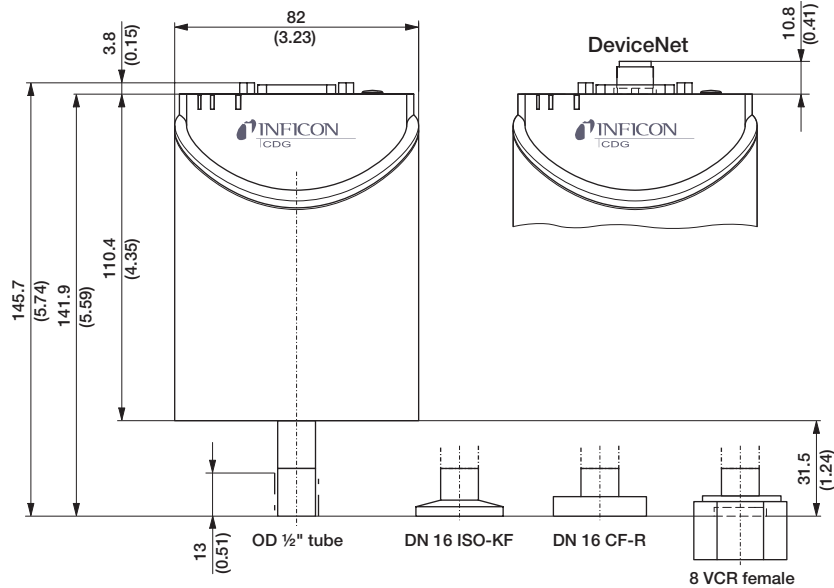

		1/2 in. tube	DN 16 ISO KF	DN 16 CF-R	8 VCR
Internal volume	cm ³ (in. ³)	4.2 (0.26)	4.2 (0.26)	4.2 (0.26)	4.2 (0.26)
Weight	g	837	852	875	897

Pressure Display for CDG

VGD500

The INFICON Vacuum Gauge Display VGD500 connects to our CDG product line to provide a 4 Digit Display. It's a small unit which displays the pressure of the gauge. The pressure reading is selectable in pressure unit Torr, mTorr, mbar and Pa.

Advantages

- 4 Digit display for easy read out
- Large 10mm active LED display - readable from distance and wide range gauge of angle
- In-line plug design
- 15pin D-Sub, no extra power connection
- Compact small size
- Compatible with all Fullscale; 100 mTorr
- Pressure Units selectable (Torr, mTorr, mbar and Pa)
- CE certified



Ordering Information

Type	VGD500
VGD500 Vacuum Gauge Display	399-653

VGD500 (continued)**Specifications**

Type		VGD500
Display		4 digits
Connection		
Gauge Side		D-Sub, 15-pin, female
Measurement cable side		D-Sub, 15-pin, male
Signal		digital input RS232
Pressure unit (adjustable)		Torr (default), mTorr, mbar, Pa
Supply		
Power consumption	W	≤1
Voltage		+14 ... +30V (dc) or +/- 15V (ac)
Degree of protection		IP 40
Temperature		
Operation	°C	+5 ... +50
Storage	°C	-20 ... +85
Use		indoors only
Connectable gauges in the measurement range (F.S.) 0.1 mbar/Torr to 1000 mbar/Torr		CDG025D / -S, CDG025D-X3, CDG045D ... CDG200D, CDG045D2 ... CDG100D2
Weight	g	58
Dimensions	mm	50x63x34

Application specific CDG solutions

INFICONs innovative ceramic capacitance diaphragm technology offers new and unique solutions. The flexible platform allows direct drop in replacements for legacy products. Please contact our sales for more information.

AllCeramic, the metal free process CDG

Only ceramic surfaces (aluminum oxide) are wetted to process media. This option is available to all CDG products (SKY, Edge, Stripe).

- Higher corrosion resistance
- Lower metal contamination
- Lower particle contamination
- Longer lifetime, less maintenance

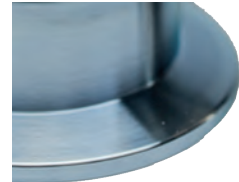

Remote CDG, custom engineered

Standard heated CDG products are not matching your design requirements? Remote heated CDG could be the perfect solution.

- Sensor integrated in hot environment
- Sensor integrated in limited space



UHP Porter

You need a UHP compatible CDG? INFICONs xParts coating lifts the product performance to UHP level matched with clean room double packaging.

- Lower particle contamination
- Chemical resistant
- Lower metal contamination



Application specific CDG solutions (continued)

Drop in retrofit solutions

You need to replace a legacy gauge of any brand? No problem, INFICON offers attractive drop in solutions for most legacy products matching other vendors pinout and functionality. Some examples are:

- Dual output
- Trip point versions with pinout and trip point voltage levels



Pin	Leagacy Gauge	INFICON Standard Gauge	INFICON drop in replacement
1	Trip point A V-level	SP1 common	SP1 voltage level
2	Pressure signal output	Signal output	Signal output
3	Trip point A N.C.	Status	SP1 normally closed contact N.C.
4	Trip point A N.O.	SP1 no	SP1 normally open contact N.O.
5	Power return	Supply common	Supply common
6	-15VDC	Supply (-15V)	Supply (-15V)
7	+15VDC	Supply (+14...+30V)	Supply (+14...+30 or +15V)
8	Trip point A Com	SP2 no	SP1 common
9	Trip point B N.O.	SP2 common	SP2 normally open contact N.O.
10	Trip point B N.C.	Gauge identification	SP2 normally closed
11	Trip point B Com	Supply	SP2 common
12	Pressure signal return	Signal common	SP2 Voltage level
13	Trip point B V-Level	RS232 TxD	SP2 Voltage level
14	No connection	RS232 RXD	Not used
15	Chassis ground	Chassis ground	Housing (Chassis ground)

You didn't find the CDG solving your application?

INFICONs ceramic capacitance diaphragm technology paired with digital signal processing and experienced engineering will offer leading, innovative solutions. Please contact INFICON and describe your measurement requirements.



Bayard-Alpert Hot Ion Gauge

BAG302

The INFICON single Bayard-Alpert Hot Ion Gauge BAG302 covers a wide measurement range from 1.3×10^{-9} mbar to 6.7×10^{-2} mbar (1×10^{-9} Torr to 5×10^{-2} Torr). The compact All in one Hot Ion gauge BAG302 offers an easy to exchange dual filament sensor, a built in OLED display, set-point relay and a long-linear analog output as well as an integrated RS485 digital interface for increased integration flexibility.

These features combined with the rugged design makes the BAG302 an affordable and repeatable process to base pressure measurement instrument of its own and provides a high value/low cost of ownership choice.

The BAG302 is considered as OEM gauge and therefore not supported by VGC50x controller series.



Advantages

- Wide measurement range from 1.3×10^{-9} mbar to 6.7×10^{-2} mbar (1×10^{-9} Torr to 5×10^{-2} Torr)
- Two long-life yttrium oxide coated iridium filaments
- Tungsten filaments on special order
- All-in-One active gauge with built-in display, set-point, analog output and standard integrated RS485 digital interface
- Bright digital OLED display with keypad for simple setup, operation and programming
- User programmable set point relay
- User programmable display units in mbar, Torr or Pa
- RoHS compliance
- User selectable Auto-ranging of emission current
- Mechanical strength and ruggedness
- Choice of various flange options
- Easy to exchange sensing element
- Compliance & standards: CE, RoHS
- Direct drop in replaces Granville-Phillips® 354 Micro-Ion® Module - identical control functions including software commands (RS485)

Applications

- Pressure measurement in semiconductor process and transfer chambers
- Industrial coating
- General vacuum measurement and control in the low to ultra high vacuum range

BAG302 (continued)

Ordering Information

Type	BAG302	Replacement Sensor
(Yt ₂ O ₃ coated iridium filaments)	OLED, SP, analog output, RS485	
DN 16 ISO-KF	352-050	352-060
DN 25 ISO-KF	352-051	352-061
DN 40 ISO-KF	352-052	352-062
DN 16 CF-R	352-053	352-063
DN 16 CF-R	352-054	352-064
3/4" tube	352-055	352-065
8 VCR female	352-056	352-066

Specifications

Type	BAG302	
Measurement range	mbar	1.3 x 10 ⁻⁹ ... 6.7 x 10 ⁻²
	Torr	1 x 10 ⁻⁹ ... 5 x 10 ⁻²
	Pa	1.3 x 10 ⁻⁷ ... 6.7
Accuracy (N ₂) ¹⁾		
1.3 x 10 ⁻⁸ ... 6.7 x 10 ⁻² mbar	% of reading	±15
1 x 10 ⁻⁸ ... 5 x 10 ⁻² Torr	% of reading	±15
Repeatability ¹⁾	% of reading	±5
Degas ²⁾		
p < 6.7 x 10 ⁻⁵	mbar	electron bombardment, 2 min (default)
p < 5.00 x 10 ⁻⁵	Torr	(programmable between 2 ... 10 min)
Temperature		
Operation (ambient)	°C	0 ... +40
Storage	°C	-40 ... +70
Bakeout at flange (sensor only, electronics removed)	°C	200
Supply voltage	V (dc)	+20 ... +28 ³⁾
Output signal analog	V	0 ... +9 (log linear)
Voltage vs. pressure	V / Decade	1
Set point relay		1 (single-pole double-throw relay (SPDT)) 1 A at 30 V (dc) resistive, or V (ac) non-inductive
Digital functions		degas, filament on/off and emission control
Interface (digital)		RS485
Emission control		Manual
Filament		Two Yt ₂ O ₃ coated Ir
Filament status		display / digital output
Electrical connection		D-Sub, 9-pin, male for analog D-Sub, 9-pin, female for RS485
Materials exposed to vacuum		Yt ₂ O ₃ , Ir, W, Ta, stainless steel, glass, Ni
Mounting orientation		any
Internal volume	cm ³ (inch ³)	16.4 (1.0)
Weight KF / CF	g (lb)	270 (0.6)

¹⁾ typically

²⁾ Reduced accuracy during degas

³⁾ 30 W protected against power reversal and transient over-voltages

BAG302 (continued)

Dimensions

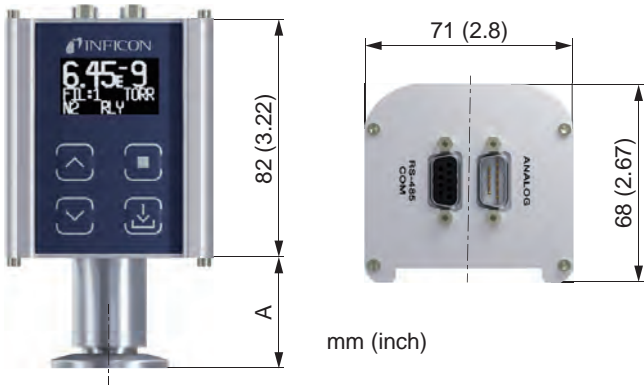

Dimension A	mm	(in)
DN 16 ISO-KF	37	(1.45)
DN 25 ISO-KF	37	(1.45)
DN 40 ISO-KF	37	(1.45)
DN 16 CF-R	47	(1.85)
DN 40 CF-R	33	(1.7)
8 VCR female	65	(2.58)
3/4" tube	55	(2.16)

Accessories

Power supply for BAG302¹⁾

352-075



Input power:	V (ac)	100 ... 240
Output power:	V (dc)	+24 @ 2.5 A (60 W)
Cable length:	m (ft)	2 (6)

¹⁾ The IEC 60320 AC power entry receptacle allows use with any user supplied AC mains cord set available worldwide

Bayard–Alpert Gauge

BAG402

The INFICON single Bayard-Alpert Hot Ion Gauge BAG402 covers a wide measurement range from 5×10^{-10} mbar to 2.7×10^{-2} mbar (3.75×10^{-10} Torr to 2×10^{-2} Torr). Choose the INFICON BAG402 for affordable and repeatable process to base pressure measurements in a compact active gauge package. The unique, supported dual filaments offer superior accuracy, longterm stability and longevity. The BAG402 is considered as OEM gauge and therefore is not supported by VGC50x controller series.



Advantages

- Measurement range from 5×10^{-10} mbar to 2.7×10^{-2} mbar (3.75×10^{-10} Torr to 2×10^{-2} Torr)
- Excellent repeatability in the process pressure range from 10^{-8} ... 10^{-2} mbar of $\pm 5\%$
- Overpressure detection protects the filament from premature burnout
- Two long-life yttrium oxide coated iridium filaments
- Emission current selection reduces control complexity
- Easy to exchange sensing element with on-board calibration data guarantees high reproducibility
- RoHS compliance

Applications

- Pressure measurement in semiconductor process and transfer chambers
- Industrial coating
- General vacuum measurement and control in the low to ultra high vacuum range

Ordering Information

Type	BAG402
Setpoint	none
Connector	D-Sub, 9-pin
Interface	analog
DN 25 ISO-KF	353-600
DN 40 CF-R	353-601
Replacement sensor DN 25 ISO-KF	354-484
Replacement sensor DN 40 CF-R	354-485

BAG402 (continued)

Accessories

Baffle	353-512
Centering ring with baffle DN 25 ISO-KF	211-113

Specifications

Type		BAG402 D-Sub, 9-pin	
Measurement range	(air, O ₂ , CO, N ₂) mbar (Torr)	5 x 10 ⁻¹⁰ ... 2.7 x 10 ⁻²	(3.75 x 10 ⁻¹⁰ ... 2 x 10 ⁻²)
Accuracy	10 ⁻⁸ ... 10 ⁻² mbar % of reading	±15	
Repeatability	10 ⁻⁸ ... 10 ⁻² mbar % of reading	5	
Degas ¹⁾	p < 7.2 x 10 ⁻⁶ mbar	Electron bombardment, max. 3 min	
Pressure, max.	bar (absolute)	2	
Temperature			
Operation (ambient)	°C	0 ... +50	
Storage	°C	-20 ... +70	
Bakeout at flange without electronics	°C	80	
Supply voltage	V / A (dc)	+20 ... +28 / ≤0.8	
Output signal analog	V	0 ... +10.5	
Measurement range	V	0.57 ... 8.31	
Voltage vs. pressure	V / Decade	1	
Error signal	V	>10	
Load impedance, min.	kΩ	10	
Digital functions		Degas and emission control	
Interface (digital)		Diagnostic port	
Emission control		Manual	
Filament		Two Yt ₂ O ₃ coated Ir	
Filament status		LED / digital output	
Electrical connection		D-Sub, 9-pin, male	
Cable length, max.	m (ft)	100 (330)	
Materials exposed to vacuum		Yt ₂ O ₃ , Ir, Pt, Mo, W, NiFe, NiCr, stainless steel, glass	
Internal volume KF / CF	cm ³ (inch ³)	24 (1.46) / 34 (2.1)	
Weight KF / CF	g	450 / 710	
Degree of protection		IP30	

¹⁾ Reduced accuracy during degas

BAG402 (continued)

Accessories

Baffle:

Prevents contamination of the sensor.
Fast and easy installation.



Dimensions

mm (in.)

BAG402 (D-Sub, 9-pin)

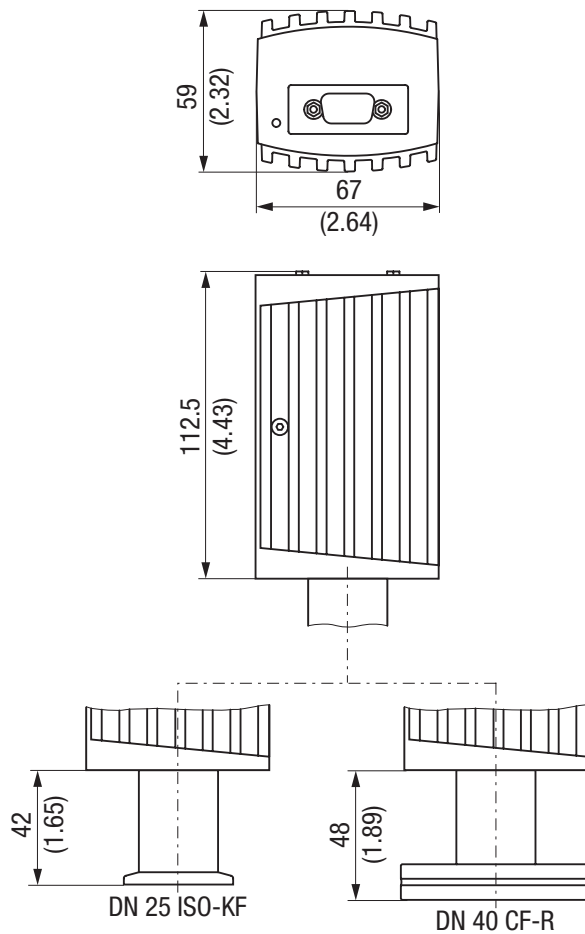

Bayard-Alpert Pirani Gauge

BPG400

The INFICON Bayard-Alpert Pirani Combination Gauge, BPG400, functions as two gauges in a single compact unit measuring from 5×10^{-10} mbar to atmosphere (3.8×10^{-10} Torr to atmosphere). Combining technologies reduces the complexity of installation, setup, and integration. Choose the BPG400 for affordable and repeatable process to base pressure measurements in one economic package.

Advantages

- Extremely wide measurement range from 5×10^{-10} mbar to atmosphere (3.8×10^{-10} Torr to atmosphere)
- Excellent repeatability in the process pressure range from 10^{-8} ... 10^{-2} mbar of 5%
- The Pirani interlock protects the Bayard-Alpert system from premature filament burnout and excess contamination from high pressure operation
- Long-life yttrium oxide coated iridium filament
- Optional graphic display and Fieldbus interfaces available
- Automatic high vacuum Pirani adjustment reduces operator interventions
- RoHS compliance

Applications

- Pressure measurement in semiconductor process and transfer chambers
- Industrial coating
- General vacuum measurement and control in the low to ultra high vacuum range



Ordering Information

Type	BPG400 without LCD	BPG400 with LCD	BPG400-SP with Profibus DP	BPG400-SD with DeviceNet
DN 25 ISO-KF	353-500	353-501	353-505	353-507
DN 40 CF-R	353-502	353-503	353-506	353-508
Replacement sensor 25 ISO-KF	354-490	354-490	354-490	354-490
Replacement sensor 40 CF-R	354-491	354-491	354-491	354-491

Accessories

Power supply 24 V (dc) / RS232C line	353-511
Bakeout extension, 100 mm (3.94 in.)	353-510
Baffle	353-512
Centering ring with baffle DN 25 ISO-KF	211-113

BPG400 (continued)

Specifications

		BPG400 Standard	BPG400 Display
Measurement range	(air, O ₂ , CO, N ₂) mbar (Torr)	5 x 10 ⁻¹⁰ ... 1000	(3.8 x 10 ⁻¹⁰ ... 750)
Accuracy	10 ⁻⁸ ... 10 ⁻² mbar % of reading	±15	
Repeatability	10 ⁻⁸ ... 10 ⁻² mbar % of reading	5	
Degas ¹⁾	p < 7.2 x 10 ⁻⁶ mbar	Electron bombardment, max. 3 min	
Pressure, max.	bar (absolute)	2	
Temperature			
Operation (ambient)	°C	0 ... +50	
Storage	°C	-20 ... +70	
Bakeout			
At flange with extension	°C	150	
At flange without extension	°C	80	
Electronics removed	°C	150	
Supply voltage	V / A (dc)	+20 ... +28 / 0.8	
Output signal analog	V	0 ... +10	
Measurement range	V	+0.774 ... +10	
Voltage vs. pressure	V / Decade	0.75	
Error signal	V	0.3 / 0.5	
Load impedance, min.	kΩ	10	
Interface (digital) ²⁾		RS232C	
Electrical connection		D-Sub, 15-pin, male	
Cable length, max. ³⁾	m (ft.)	100 (330)	
Materials exposed to vacuum		Yt ₂ O ₃ , Ir, Pt, Mo, Cu, W, NiFe, NiCr, stainless steel, glass	
Internal volume KF / CF	cm ³ (in. ³)	24 (1.46) / 34 (2.1)	
Weight KF / CF	g	285 / 550	
Degree of protection		IP30	

¹⁾ Reduced accuracy during degas

²⁾ Simultaneous use of RS232C or VGC400 series controllers and Fieldbus is not allowed

³⁾ For RS232C operation <30 m

Specifications (Profibus DP)

		BPG400-SP Profibus DP
Baud rates	kBaud MBaud	9.6 / 19.2 / 93.75 / 187.5 / 500 1.5 / 12
Address		Two switches (address 00 - 127) or network programmable
Digital functions		Read pressure, select units: Torr, mbar, Pa Degas function, Pirani full scale adjust Monitor gauge status Safe state allows definition of behavior in case of error Detailed alarm and warning information
Analog functions		0 ... 10 V analog output pressure indication two setpoint relays A + B
Setpoint relays		2
Range	mbar	1 x 10 ⁻⁹ ... 100
Relay contact		n.o., potential free
Hysteresis	% of reading	10
Contact rating	V / A (dc)	60 / 0.5
Connector for Profibus DP		D-Sub, 9-pin, female
Connector for BPG (analog output, supply voltage, setpoints)		D-Sub, 15-pin, male

BPG400 (continued)

Specifications (DeviceNet)

			BPG400-SD DeviceNet
Protocol			DeviceNet, group 2 slave only
Data rate switch	kBaud		125, 250, 500 or network programmable
Cable length			
125 kbps	m (ft.)		500 (1650)
250 kbps	m (ft.)		250 (825)
500 kbps	m (ft.)		100 (330)
MAC ID			Two switches (address 00 – 63) or network programmable
Digital functions			Read pressure, select units: Torr, mbar, Pa Degas function, Pirani full scale adjust Monitor gauge status Safe state allows definition of behavior in case of error Detailed alarm and warning information
Analog functions			0 ... 10 V analog output pressure indication two setpoint relays A + B
Specification			DeviceNet "Vacuum Gauge Device Profile"
Device type			"CG" for combination gauge
I/O slave messaging			Polling only
Setpoint relays			2
Range	mbar		1×10^{-9} ... 100
Relay contact			n.o., potential free
Hysteresis	% of reading		10
Contact rating	V / A (dc)		60 / 0.5
Supply voltage for DeviceNet	V / A (dc)		+11 ... +25 / 0.5
Supply voltage for gauge	V / A (dc)		+20 ... +28 / 0.8
Connector for DeviceNet			Microstyle, 5-pin
Connector for BPG (analog output, supply voltage, setpoints)			D-Sub, 15-pin, male

BPG400 (continued)

Dimensions

mm (in.)

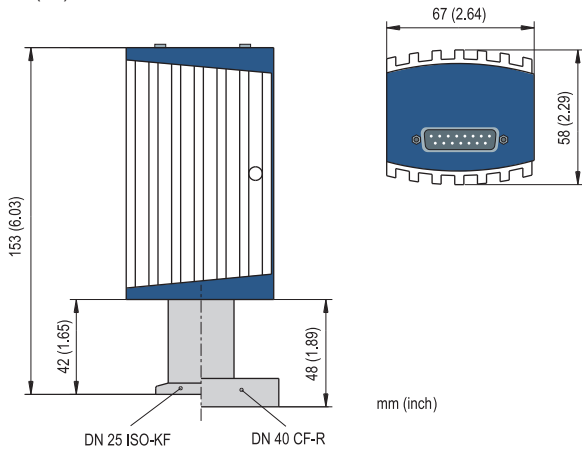

mm (inch)

Accessories

Power supply 24 V (dc) / RS232C line

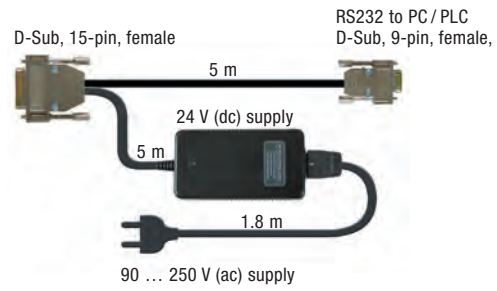

Bakeout extension:

Allows measurement at flange temperatures up to 150°C.
Easy installation into the vacuum connection - no tools required.



Baffle:

Prevents contamination of the sensor.
Fast and easy installation.



Bayard–Alpert Pirani Gauge

BPG402–S

The INFICON Bayard-Alpert Pirani Combination Gauge, BPG402-S, functions as two gauges in a single compact unit measuring from 5×10^{-10} mbar to atmosphere (3.8×10^{-10} Torr to atmosphere). Combining technologies reduces the complexity of installation, setup, and integration. Choose the BPG402-S with two yttrium oxide coated iridium filaments for affordable and repeatable process to base pressure measurements in one economical package. Sensing elements with on-board calibration data guarantees high reproducibility when exchanging sensors.



Advantages

- Extremely wide measurement range from 5×10^{-10} mbar to atmosphere (3.8×10^{-10} Torr to atmosphere)
- Excellent repeatability in the process pressure range from $10^{-8} \dots 10^{-2}$ mbar of 5%
- Pirani interlock protects the filament from premature burnout
- Two long-life yttrium oxide coated iridium filaments
- Optional graphic display and Fieldbus interfaces available, e.g. EtherCAT
- Automatic high vacuum Pirani adjustment reduces operator interventions
- Easy to exchange sensing element with on-board calibration data guarantees high reproducibility
- RoHS compliance

Applications

- Pressure measurement in semiconductor process and transfer chambers
- Industrial coating
- General vacuum measurement and control in the low to ultra high vacuum range

Ordering Information

Type	BPG402-S without display	BPG402-S with display	BPG402-SL with long tube without display	BPG402-SP with Profibus DP	BPG402-SD with DeviceNet	BPG402-SE with EtherCAT
DN 25 ISO-KF	353-570	353-572	–	353-574	353-576	353-590
DN 40 CF-R	353-571	353-573	353-578	353-575	353-577	353-591
Replacement sensor 25 ISO-KF	354-494	354-494	–	354-494	354-494	354-494
Replacement sensor 40 CF-R	354-495	354-495	354-496	354-495	354-495	354-495

BPG402-S (continued)

Accessories

Power supply 24 V (dc) / RS232C line	353-511
Baffle	353-512
Centering ring with baffle DN 25 ISO-KF	211-113

Specifications

		BPG402-S / -SL Standard		BPG402-S Display	
Measurement range (air, O ₂ , CO, N ₂)	mbar (Torr)	5 x 10 ⁻¹⁰ ... 1000	(3.8 x 10 ⁻¹⁰ ... 750)		
Accuracy	10 ⁻⁸ ... 10 ⁻² mbar % of reading	±15			
Repeatability	10 ⁻⁸ ... 10 ⁻² mbar % of reading	5			
Degas ¹⁾	p < 7.2 x 10 ⁻⁶ mbar	Electron bombardment, max. 3 min			
Pressure, max.	bar (absolute)	2			
Temperature					
Operation (ambient)	°C	0 ... +50			
Storage	°C	-20 ... +70			
Bakeout at flange without electronics					
BPG402-S	°C	80			
BPG402-SL	°C	150			
Supply voltage	V / A (dc)	+20 ... +28 / ≤0.8			
Output signal analog	V	0 ... +10			
Measurement range	V	+0.774 ... +10			
Voltage vs. pressure	V / Decade	0.75			
Error signal	V	0.1 / 0.3 / 0.5			
Load impedance, min.	kΩ	10			
Set point relay		1			
Range	mbar	1 x 10 ⁻⁹ ... 100			
Relay contact		n.o., potential free			
Hysteresis	% of reading	10			
Contact rating	V / A (dc)	≤30 / ≤0.5			
Digital functions		Degas			
Interface (digital) ²⁾		RS232C			
Emission control		Automatic / manual via interface			
Filament		Two Yt ₂ O ₃ coated Ir			
Filament status		LED / digital output			
Electrical connection		D-Sub, 15 pin, male			
Cable length, max. ³⁾	m (ft.)	100 (330)			
Materials exposed to vacuum		Yt ₂ O ₃ , Ir, Pt, Mo, Cu, W, NiFe, NiCr, stainless steel, glass			
Internal volume KF / CF	cm ³ (in. ³)	24 (1.46) / 34 (2.1)			
Weight KF / CF	g	450 / 710			
Degree of protection		IP30			

¹⁾ Reduced accuracy during degas

²⁾ Simultaneous use of RS232C or VGC400 series controllers and Fieldbus is not allowed

³⁾ For RS232C operation <30 m

BPG402-S (continued)

Specifications (Profibus DP)

		BPG402-SP Profibus DP
Baud rates	kBaud MBaud	9.6 / 19.2 / 93.75 / 187.5 / 500 1.5 / 12
Address		Two switches (address 00 – 127) or network programmable
Digital functions		Read pressure, select units: Torr, mbar, Pa Emission control, degas function Monitor gauge status, filament status Safe state allows definition of behavior in case of error Detailed alarm and warning information
Analog functions		0 ... 10 V analog output pressure indication Two setpoint relays A + B
Setpoint relays		2
Range	mbar	$1 \times 10^{-9} \dots 100$
Relay contact		n.o., potential free
Hysteresis	% of reading	10
Contact rating	V / A (dc)	$\leq 30 / \leq 0.5$
Connector for Profibus DP		D-Sub, 9 pin, female
Connector for BPG (analog output, supply voltage, setpoints)		D-Sub, 15 pin, male

Specifications (EtherCAT)

		BPG402-SE EtherCAT
Protocol		EtherCAT
Communication Standards		ETG.5003 Part 1 ¹⁾ ETG.5003 Part 2080 ²⁾ Specific Device Profile: Vacuum Gauge
Node address		Explicit Device Identification
Physical layer		100BASE-Tx-(IEEE 802.3)
Digital functions		read pressure, select units: Torr, mbar, Pa emission control, degas function monitor gauge status, filament status safe state allows definition of behavior in case of error detailed alarm and warning information
Setpoint relays		2
Range	mbar	$1 \times 10^{-9} \dots 100$
Relay contact		n.o., potential free
Hysteresis	% of reading	10
Contact rating	V / A (dc)	$\leq 30 / \leq 0.5$
EtherCAT connector		2 × RJ45, 8-pin (socket), input and output
Cable		special Ethernet Patch Cable or Crossover Cable, shielded (CAT5e quality or higher)
Cable length	m (ft)	≤ 100 (330)
Process data		fixed PDO mapping and configurable PDO mapping
Mailbox (CoE)		SDO requests, responses and information

¹⁾ Semiconductor Device Profile

²⁾ Specific Device Profile: Vacuum Pressure Gauge

BPG402–S (continued)

Specifications (DeviceNet)

		BPG402-SD DeviceNet
Protocol		DeviceNet, group 2 slave only
Data rate switch	kBaud	125, 250, 500 or network programmable
Cable length		
125 kbps	m (ft.)	500 (1650)
250 kbps	m (ft.)	250 (825)
500 kbps	m (ft.)	100 (330)
MAC ID		Two switches (address 00 – 63) or network programmable
Digital functions		Read pressure, select units: Torr, mbar, Pa Emission control, degas function Monitor gauge status, filament status Safe state allows definition of behavior in case of error Detailed alarm and warning information
Analog functions		0 ... 10 V analog output pressure indication Two setpoint relays A + B
Specification		DeviceNet "Vacuum Gauge Device Profile"
Device type		"CG" for combination gauge
I/O slave messaging		Polling only
Setpoint relays		2
Range	mbar	$1 \times 10^{-9} \dots 100$
Relay contact		n.o., potential free
Hysteresis	% of reading	10
Contact rating	V / A (dc)	$\leq 30 / \leq 0.5$
Supply voltage for DeviceNet	V / A (dc)	+11 ... +25 / ≤ 0.5
Supply voltage for gauge	V / A (dc)	+20 ... +28 / ≤ 0.8
Connector for DeviceNet		Microstyle, 5 pin
Connector for BPG (analog output, supply voltage, setpoints)		D-Sub, 15 pin, male

BPG402-S (continued)

Dimensions

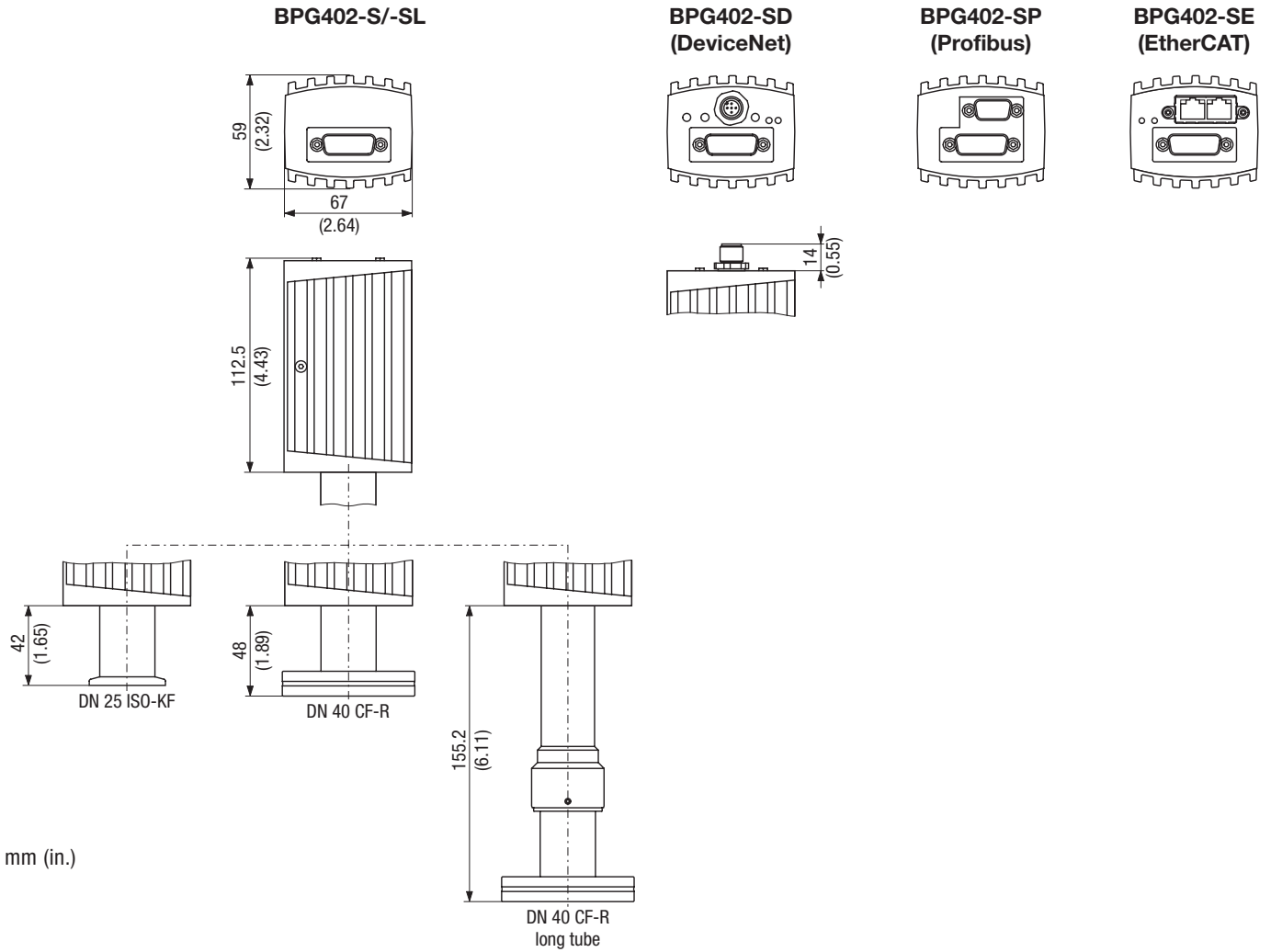

Accessories

Power supply 24 V (dc) / RS232C line

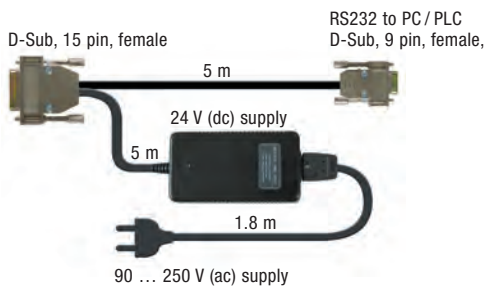

Baffle:

Prevents contamination of the sensor.
Easy installation into the vacuum connection - no tools required.

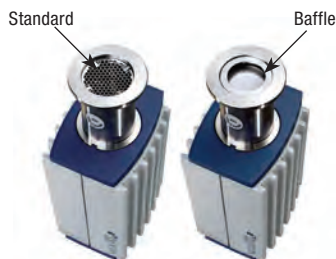

High Pressure Hot Ionization Pirani Gauge

HPG400

The INFICON High Pressure Hot Ionization Pirani Gauge, HPG400, combines High Pressure Hot Ionization and Pirani sensors in a single, compact, economical package to measure pressure from 2×10^{-6} mbar to atmosphere (1.5×10^{-6} Torr to atmosphere). The HPG400 provides highly repeatable and reproducible pressure measurement for accurate sputter process pressure control.

Advantages

- HPG400 saves cost and tool space and reduces the complexity of vacuum system installation and setup
- The high pressure hot ion gauge delivers accurate, reliable pressure measurements from 1×10^{-5} ... 1 mbar for improved process control
- User selectable hot ion emission activation between 5×10^{-2} and 1 mbar
- Pirani interlock protects the hot filament from premature burnout
- Optional graphic display and Fieldbus interfaces available
- Automatic high vacuum Pirani adjustment reduces operator interventions
- RoHS compliance

Applications

- Sputter applications in semiconductor manufacturing, electronics and media industry
- Industrial coating
- General vacuum measurement and control in the low to high vacuum range



Ordering Information

Type	HPG400 without LCD	HPG400 with LCD	HPG400-SP with Profibus DP ¹⁾	HPG400-SD with DeviceNet ¹⁾
DN 25 ISO-KF	353-520	353-521	353-525	353-527
DN 40 CF-F	353-522	353-523	353-526	353-528
Replacement sensor 25 ISO-KF	354-487	354-487	354-487	354-487
Replacement sensor 40 CF-R	354-488	354-488	354-488	354-488

¹⁾ Not available with LCD

Accessories

Power supply 24 V (dc) / RS232C line	353-511
Centering ring with baffle DN 25 ISO-KF	211-113

HPG400 (continued)

Specifications

		HPG400 Standard	HPG400 Display
Measurement range (air, N ₂)	mbar (Torr)	2 x 10 ⁻⁶ ... 1000 (1.5 x 10 ⁻⁶ ... 750)	
Accuracy	10 ⁻⁵ ... 1 mbar % of reading	±15 ¹⁾	
Repeatability	10 ⁻⁵ ... 10 ⁻¹ mbar % of reading	2	
	10 ⁻¹ ... 100 mbar % of reading	30	
Hot ion emission on, selectable	mbar	1	
	mbar	5 x 10 ⁻¹	
	mbar	2 x 10 ⁻¹	
	mbar	1 x 10 ⁻¹	
	mbar	5 x 10 ⁻²	
Pressure, max.	bar (absolute)	2	
Temperature			
Operation (ambient)	°C	0 ... +50	
Storage	°C	-20 ... +70	
Bakeout			
At flange	°C	80	
Electronics removed	°C	150	
Supply voltage	V / A (dc)	20 ... 28 / 0.8	
Output signal analog			
Measurement range			
Hot cathode	V	1.5 ... 7.5	
Pirani	V	8.5 ... 9.75	
Voltage vs. pressure			
Hot cathode	V / Decade	1	
Pirani	V / Decade	0.25	
Error signal			
Hot cathode	V	0.3	
Pirani	V	0.5	
Load impedance, min.	kΩ	10	
Interface (digital) ²⁾		RS232C	
Electrical connection		D-Sub, 15-pin, male	
Cable length, max. ³⁾	m (ft.)	100 (330)	
Materials exposed to vacuum		Yt ₂ O ₃ , Ir, Pt, Mo, Cu, W, NiFe, NiCr, stainless steel, glass	
Internal volume KF / CF	cm ³ (in. ³)	20 (1.2) / 30 (1.8)	
Weight KF / CF	g	430 / 695	
Degree of protection		IP30	

¹⁾ Accuracy from 10⁻⁵ mbar to the selected hot ion emission on value

²⁾ Simultaneous use of RS232C or VGC400 series controllers and Fieldbus is not allowed

³⁾ For RS232C operation <30 m

HPG400 (continued)

Specifications (DeviceNet)

			HPG400-SD DeviceNet
Protocol			DeviceNet, group 2 slave only
Data rate switch	kBaud		125, 250, 500 or network programmable
Cable length			
125 kbps	m (ft.)		500 (1650)
250 kbps	m (ft.)		250 (825)
500 kbps	m (ft.)		100 (330)
MAC ID			Two switches (address 00 – 63) or network programmable
Network size			Up to 64 nodes per segment
Digital functions			Read pressure, select units: Torr, mbar, Pa Pirani full scale adjust Monitor gauge status Safe state allows definition of behavior in case of error Detailed alarm and warning information
Analog functions			0 ... 10 V analog output pressure indication two setpoint relays A + B
Visual communication indicators			LED network status (green / red) LED module status (green / red)
Specification			DeviceNet "Vacuum Gauge Device Profile"
Device type			"CG" for combination gauge
I / O slave messaging			Polling only
Setpoint relays			2
Range	mbar		2×10^{-6} ... 100
Relay contact			n.o., potential free
Hysteresis	% of reading		10
Contact rating	V (dc) / A		60 / 0.5
Supply voltage for DeviceNet	V (dc) / A		11 ... 25 / 0.5
Supply voltage for gauge	V (dc) / A		20 ... 28
Connector for DeviceNet			Microstyle, 5-pin
Connector for HPG (analog output, supply voltage, setpoints)			D-Sub, 15-pin, male

Specifications (Profibus DP)

			HPG400-SP Profibus DP
Baud rates	kBaud		9.6 / 19.2 / 93.75 / 187.5 / 500
	MBaud		1.5 / 12
Address			Two switches (address 00 - 127) or network programmable
Digital functions			Read pressure, select units: Torr, mbar, Pa Pirani full scale adjust Monitor gauge status Safe state allows definition of behavior in case of error Detailed alarm and warning information
Analog functions			0 ... 10 V analog output pressure indication two setpoint relays A + B
Setpoint relays			2
Range	mbar		1×10^{-6} ... 100
Relay contact			n.o., potential free
Hysteresis	% of reading		10
Contact rating	V (dc) / A		60 / 0.5
Connector for Profibus DP			D-Sub, 9-pin, female
Connector for HPG (analog output, supply voltage, setpoints)			D-Sub, 15-pin, male

HPG400 (continued)

Dimensions

mm (in.)

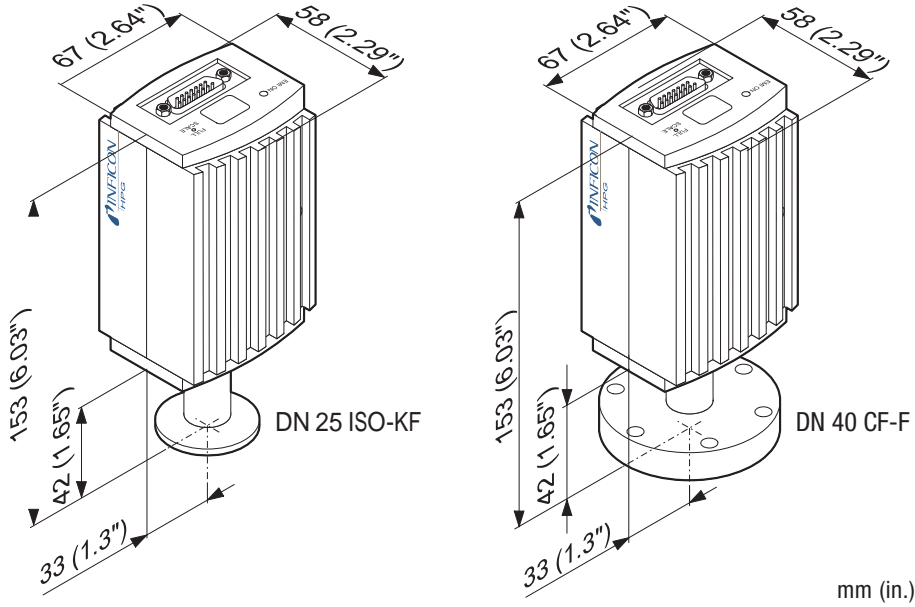

Accessories

Power supply 24 V (dc) / RS232C line

D-Sub, 15-pin, female

RS232 to PC / PLC
D-Sub, 9-pin, female

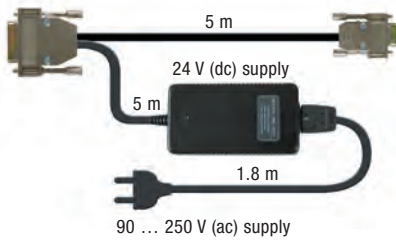

Pirani Gauge Enhanced

PGE500

The INFICON Pirani Gauge Enhanced (PGE) is equipped with the latest digital convection enhanced Pirani technology available on the market. Due to the physical properties of convection this type of Pirani offers higher accuracy in the measurement range between 100 to 1000 mbar. The rugged gauge and sensor design in combination with many factory build in features, such as the bright, sharp and clear OLED display with integrated keypad, RS485/RS232 digital interface and 4 selectable analog output signals make the PGE500 a high value/ low cost of ownership choice. All these features qualify this gauge for many applications where an economical vacuum measurement from low to high vacuum range is required.



Advantages

- Convection Enhanced Pirani Technology for wide measurement range and higher accuracy near atmosphere
- All-in-One active gauge with built-in display, 2 set points, 4 analog output signals, and 2 digital interfaces
- Bright digital OLED display with keypad for simple setup, calibration and operation
- 4 optional analog output signals (3 user selectable, 1 default)
- Factory pre-set analog output signal or selectable via keypad
- Factory pre-set display units or selectable via keypad
- User programmable set point relays (factory pre-set on request for volume orders)
- Gold plated tungsten filament
- Mechanical strength, highly robust and less susceptible to mechanical shock and vibration
- Choice of flange options
- Compliance & standards: CE, RoHS
- Direct drop in replaces most Granville-Phillips® Mini-Convectron® modules (GP275)

Applications

- Fore vacuum pressure measurement
- General vacuum measurement and control from low to the high vacuum range

PGE500 (continued)

Ordering Information

3 P E 5 - 0 0 1 - B 7 F 0

Unit	
mbar	0
Torr	1
Pa	2

Flange	
DN 16 ISO-KF	1
DN 16 CF-R	3
DN 25 ISO-KF	6
DN 40 ISO-KF	7
DN 40 CF-R	8
4 VCR female	D
8 VCR female	E
1/8" NPT	F

Output Signal Analog	
0	1.15 ... 10.215 V ¹⁾
2	0.375 ... 5.659 V ²⁾
5	1 ... 8 V ³⁾
-	0 ... 10 V ⁴⁾

- 1) log-linear, $p=10^{0.778(U-c)}$
- 2) non-linear S-curve, compatible to most Granville-Phillips® Mini-Convectron® modules (GP275)
- 3) log-linear, $p=10^{(V-5)}$
- 4) linear, available on all devices by default on pin 9

PGE500 (continued)

Specifications

Type	PGE500	
Filament	Tungsten gold-plated	
Measurement range	mbar	1.3×10^{-4} ... 1333
	Torr	1×10^{-4} ... 1000
	Pa	1.3×10^{-2} ... 133000
Accuracy (N ₂) ¹⁾		
1.3×10^{-4} ... 1.3×10^{-3} mbar		0.1 x 10 ⁻³ mbar resolution
1.3×10^{-3} ... 530 mbar	% of reading	±10
530 ... 1333 mbar	% of reading	±2.5
1×10^{-4} ... 1×10^{-3} Torr		0.1 mTorr resolution
1×10^{-3} ... 400 Torr	% of reading	±10
400 ... 1000 Torr	% of reading	±2.5
Repeatability (N ₂) ¹⁾	% of reading	±2
Admissible Temperature		
Operation	°C	0 ... +40
Storage	°C	-40 ... +70
Bakeout (electronics removed)	°C	≤150
Supply voltage	V (dc)	+12 ... +28) ²⁾
Output signal (analog)		
3PE5-0xx-B7F0	V (dc)	1.15 ... 10.215 (log-linear)
3PE5-0xx-B7F2	V (dc)	0.375 ... 5.659 (non-linear S-curve)
3PE5-0xx-B7F5	V (dc)	1 ... 8 (log-linear)
3PE5-0xx-B7F- ³⁾	V (dc)	1 ... 10 (linear)
Voltage vs. pressure		
3PE5-0xx-B7F0	V / Decade	1.286
3PE5-0xx-B7F5	V / Decade	1
Setpoint relay		2 (single-pole double-throw relays (SPDT)) 1 A at 30 V (dc) resistive, or V (ac) non-inductive
Electrical connection		D-Sub, 9-pin, male and D-Sub, 15-pin HD, male (with RS485)
Mounting orientation		horizontal recommended ⁴⁾
Materials exposed to vacuum		gold-plated tungsten, 304 & 316 stainless steel, glass, nickel, Teflon®
Internal volume	cm ³ (in. ³)	26 (1.589)
Internal surface area	cm ² (in. ²)	59.7 (9.25)
Weight	g (oz)	340 (12)

¹⁾ typically

²⁾ 2 W protected against power reversal and transient over-voltages

³⁾ available on all devices by default on pin 9

⁴⁾ orientation has no effect on measurements below 1.3 mbar (1 Torr)

PGE500 (continued)

Dimensions

mm (in.)



Dimension A

	mm	(in)
DN 16 ISO-KF	29.5	(1.16)
DN 25 ISO-KF	29.5	(1.16)
DN 40 ISO-KF	29.5	(1.16)
DN 16 CF-R	34	(1.34)
DN 40 CF-R	34	(1.34)
4 VCR female	43.7	(1.72)
8 VCR female	40.9	(1.61)
1/8" NPT	21.8	(0.86)

Accessories

Power supply for PGE300 & PGE500¹⁾

352-525



Input power:	V (ac)	100 ... 240
Output power:	V (dc)	+24 @ 2.5 A (60 W)
Cable length:	m (ft)	2 (6)

¹⁾ The IEC 60320 AC power entry receptacle allows use with any user supplied AC mains cord set available worldwide

Pirani Gauge Enhanced

PGE300

The INFICON Pirani Gauge Enhanced 300 (PGE300) like its bigger brother PGE500 is equipped with the latest digital convection enhanced Pirani technology available on the market. Equipped with the same sensor components as the PGE500, the PGE300 yields the same higher accuracy readings in the measurement range between 100 to 1000 mbar. The PGE300 offers only the critical built-in features that the majority of customers in the vacuum industry are looking for, minimizing costs and maximizing efficiency. This rugged gauge and sensor design, in combination with the factory built in clear readable LED display, 3 selectable analog output signals and a set point relay makes the PGE300 a high value/low cost of ownership choice not only for OEM customers, but all customers. These features qualify this gauge for many applications where an economical vacuum measurement from low to high vacuum range is required. With its wider measuring range and higher accuracy, especially at lower pressures in combination with the economically priced built in features the PGE300 also is the first choice when replacing thermocouple gauges in your vacuum system.



Advantages

- Convection Enhanced Pirani Technology for wide measurement range and higher accuracy near atmosphere
- All-in-One active gauge with built-in display, 1 set point and 3 selectable analog output signals
- Bright digital LED display features a user friendly for calibration and operation
- 3 optional analog output signals (user selectable)
- Factory pre-set analog output signal or selectable via user interface
- User programmable set point relays
- Gold plated tungsten filament
- Mechanical strength, highly robust and less susceptible to mechanical shock and vibration
- Choice of flange options
- Compliance & standards: CE, RoHS
- Direct drop in replaces most Granville-Phillips® Mini-Convectron® modules (GP275) and ideal device for upgrading your installed thermocouple gauges

Applications

- Fore vacuum pressure measurement
- General vacuum measurement and control from low to the high vacuum range

PGE300 (continued)

Ordering Information

3 P E 5 - 0 0 1 - A 7 0 0

Unit
 mbar 0
 Torr 1

Flange
 DN 16 ISO-KF 1
 DN 16 CF-R 3
 DN 25 ISO-KF 6
 DN 40 ISO-KF 7
 DN 40 CF-R 8
 4 VCR female D
 8 VCR female E
 1/8" NPT F

Output Signal Analog
 0 0.61 ... 10.23 V
 2 0.375 ... 5.659 V
 5 1 ... 8 V

PGE300 (continued)

Specifications

Type		PGE300
Filament		Tungsten gold-plated
Measurement range	mbar Torr Pa	1.3×10^{-4} ... 1333 1×10^{-4} ... 1000 1.3×10^{-2} ... 1333000
Accuracy (N ₂) ¹⁾		0.1 x 10 ⁻³ mbar resolution
1.3 x 10 ⁻⁴ ... 1.3 x 10 ⁻³ mbar	% of reading	±10
1.3 x 10 ⁻³ ... 530 mbar	% of reading	±2.5
530 ... 1333 mbar	% of reading	
1 x 10 ⁻⁴ ... 1 x 10 ⁻³ Torr		0.1 mTorr resolution
1 x 10 ⁻³ ... 400 Torr	% of reading	±10
400 ... 1000 Torr	% of reading	±2.5
Repeatability (N ₂) ¹⁾	% of reading	±2
Admissible Temperature		
Operation	°C	0 ... +40
Storage	°C	-40 ... +70
Bakeout	°C	≤70
Supply voltage	V (dc)	+12 ... +28) ²⁾
Output signal (analog)		
3PE5-0xx-A700	V (dc)	0.61 ... 10.23 (log-linear)
3PE5-0xx-A702	V (dc)	0.375 ... 5.659
3PE5-0xx-A705	V (dc)	1 ... 8 (log-linear)
Voltage vs. pressure		
3PE5-0xx-A700	V / Decade	1.286
3PE5-0xx / -A705	V / Decade	1
Setpoint relay		1 (single-pole double-throw relay (SPDT)) 1 A at 30 V (dc) resistive, or V (ac) non-inductive
Electrical connection		D-Sub, 9-pin, male
Mounting orientation		horizontal recommended ³⁾
Materials exposed to vacuum		gold-plated tungsten, 304 & 316 stainless steel, glass, nickel, Teflon®
Internal volume	cm ³ (in. ³)	26 (1.589)
Internal surface area	cm ² (in. ²)	59.7 (9.25)
Weight	g (oz)	136 (4.8)

¹⁾ typically

²⁾ 2 W protected against power reversal and transient over-voltages

³⁾ orientation has no effect on measurements below 1.3 mbar (1 Torr)

PGE300 (continued)

Dimensions

mm (in.)



Dimension A	mm	(in)
DN 16 ISO-KF	33	(1.3)
DN 25 ISO-KF	33	(1.3)
DN 40 ISO-KF	33	(1.3)
DN 16 CF-R	27.4	(1.08)
DN 40 CF-R	37.3	(1.47)
4 VCR female	47.2	(1.86)
8 VCR female	44.5	(1.75)
1/8" NPT male	25.4	(1)

Accessories

Power supply for PGE300 & PGE500¹⁾

352-525



Input power:	V (ac)	100 ... 240
Output power:	V (dc)	+24 @ 2.5 A (60 W)
Cable length:	m (ft)	2 (6)

¹⁾ The IEC 60320 AC power entry receptacle allows use with any user supplied AC mains cord set available worldwide

Bayard–Alpert Pirani Capacitance Diaphragm Gauge

TripleGauge BCG450

The INFICON Bayard-Alpert Pirani Capacitance Diaphragm Gauge, BCG450, combines the advantages of three different technologies in a single, compact, economical package to measure process and base pressure from 5×10^{-10} to 1500 mbar (3.75×10^{-10} to 1125 Torr). The BCG450 is designed to take the place of three sensors (hot ion, convection enhanced Pirani and vacuum switch), thus reducing cost and valuable tool space.

Advantages

- BCG450 saves cost and tool space and reduces the complexity of vacuum measurement installation and setup
- Gas-type-independent pressure measurement above 10 Torr provides more reliable loadlock control for any gas-mixture
- Pirani interlock protects the hot filament from premature burnout
- Automatic high vacuum Pirani adjustment reduces operator interventions
- Differential pressure measurement at atmosphere eliminates uncertainty related to atmospheric pressure changes
- Easy-to-exchange sensing element with on-board calibration data guarantees reproducibility
- Optional graphic display and Fieldbus interfaces available, e.g. EtherCAT
- RoHS compliance

Applications

- Pressure measurement in Semiconductor process, transfer and loadlock chambers
- Industrial coating
- General vacuum measurement and control on systems in the low to ultra high vacuum range

Ordering Information

Type	BCG450 without LCD	BCG450 with LCD	BCG450-SP with Profibus DP ¹⁾	BCG450-SD with DeviceNet ¹⁾	BCG450-SE with EtherCAT ¹⁾
DN 25 ISO-KF	353-550	353-552	353-554	353-557	353-592
DN 40 CF-R	353-551	353-553	353-556	353-558	353-593
Replacement sensor 25 ISO-KF	354-492	354-492	354-492	354-492	354-492
Replacement sensor 40 CF-R	354-493	354-493	354-493	354-493	354-493

¹⁾ Not available with LCD display

Accessories

Power supply 24 V (dc) / RS 232 C line	353-511
Baffle	353-512
Centering ring with baffle DN 25 ISO-KF	211-113



TripleGauge BCG450 (continued)

Specifications

		BCG450 Standard	BCG450 Display
Measurement range	mbar (Torr)	5 x 10 ⁻¹⁰ to 1500 (3.75 x 10 ⁻¹⁰ to 1125)	
Accuracy	10 ⁻⁸ ... 50 mbar	% of reading	±15
	50 ... 950 mbar	% of reading	±5
	950 ... 1050 mbar	% of reading	±2.5
Repeatability	10 ⁻⁸ ... 10 ⁻² mbar	% of reading	5
Hot ion emission on	mbar	2 x 10 ⁻² (high)	
(selectable high / low, via RS232 / Fieldbus)	mbar	8 x 10 ⁻³ (low)	
Degas ¹⁾ p < 7.2 x 10 ⁻⁶	mbar	Electron bombardment, max. 3 min	
Pressure, max.	bar (absolute)	5	
Temperature			
Operation (ambient)	°C	0 ... +50	
Storage	°C	-20 ... +70	
Bakeout			
At flange	°C	80	
Electronics removed	°C	150	
Supply voltage	V / A (dc)	20 ... 28 / 0.8	
Output signal analog	V	0 ... 10.3	
Measurement range	V	0.774 ... 10.3	
Relation voltage / pressure	V / Decade	0.75	
Error signal	V	0.3 / 0.5	
Minimum load	kΩ	10	
Interface (digital) ²⁾		RS232C	
Connector		D-Sub, 15-pin, male	
Cable length, max. ³⁾	m (ft.)	100 (330)	
Materials exposed to vacuum		Yt ₂ O ₃ , Ir, Mo, Cu, W, NiFe, NiCr, Al ₂ O ₃ , SnAg, stainless steel, glass	
Internal volume KF / CF	cm ³ (in. ³)	24 (1.46) / 34 (2.1)	
Weight KF / CF	g	285 / 550	
Degree of protection		IP30	

¹⁾ Reduced accuracy during degas

²⁾ Simultaneous use of RS232C or VGC400 series controllers and Fieldbus is not allowed

³⁾ For RS232C operation <30m

TripleGauge BCG450 (continued)

Specifications (Profibus DP)

		BCG450-SP Profibus DP
Baud rates	kBaud MBaud	9.6 / 19.2 / 93.75 / 187.5 / 500 1.5 / 12
Address		Two switches (address 00 – 127) or network programmable
Digital functions		Read pressure, select units: Torr, mbar, Pa Degas function Monitor gauge status Safe state allows definition of behavior in case of error Detailed alarm and warning information
Analog functions		0 ... 10 V analog output pressure indication two setpoint relays A + B
Setpoint relays		2
Range	mbar	$1 \times 10^{-9} \dots 1400$
Relay contact		n.o., potential free
Hysteresis	% of reading	10
Contact rating	V / A (dc)	60 / 0.5
Connector for Profibus DP		D-Sub, 9-pin, female
Connector for BCG (analog output, supply voltage, setpoints)		D-Sub, 15-pin, male

Specifications (EtherCAT)

		BCG450-SE EtherCAT
Protocol		EtherCAT
Communication standard		ETG.5003 Part 1 ¹⁾ ETG.5003 Part 2080 ²⁾
Node address		Explicit Device Identification
Physical layer		100BASE-Tx (IEEE 802.3)
Digital functions		read pressure, select units: Torr, mbar, Pa degas function monitor gauge status safe state allows definition of behavior in case of error detailed alarm and warning information
Setpoint relays		2
Range	mbar	$1 \times 10^{-9} \dots 1400$
Relay contact		n.o., potential free
Hysteresis	% of reading	10
Contact rating	V / A (dc)	60 / 0.5
EtherCAT connector		2 x RJ45, 8-pin (socket), input and output
Cable		special Ethernet Patch Cable or Crossover Cable, shielded (CAT5e quality or higher)
Cable length	m (ft)	≤100 (330)
Process data		fixed PDO mapping and configurable PDO mapping
Mailbox (CoE)		SDO requests, responses and information

¹⁾ Semiconductor Device Profile

²⁾ Specific Device Profile: Vacuum Pressure Gauge

TripleGauge BCG450 (continued)

Specifications (DeviceNet)

		BCG450-SD DeviceNet
Protocol		DeviceNet, group 2 slave only
Data rate switch	kBaud	125, 250, 500 or network programmable
Cable length		
125 kbps	m (ft.)	500 (1650)
250 kbps	m (ft.)	250 (825)
500 kbps	m (ft.)	100 (330)
MAC ID		Two switches (address 00 – 63) or network programmable
Network size		Up to 64 nodes per segment
Digital functions		Read pressure, select units: Torr, mbar, Pa Degas function Monitor gauge status Safe state allows definition of behavior in case of error Detailed alarm and warning information
Analog functions		0 ... 10 V analog output pressure indication two setpoint relays A + B
Visual communication indicators		LED network status (green / red) LED module status (green / red)
Specification		DeviceNet "Vacuum Gauge Device Profile"
Device type		"CG" for combination gauge
I/O slave messaging		polling only
Setpoint relays		2
Range	mbar	1×10^{-9} ... 1400
Relay contact		n.o., potential free
Hysteresis	% of reading	10
Contact rating	V / A (dc)	60 / 0.5
Connector		D-Sub, 15-pin, male
Supply voltage for DeviceNet	V / A (dc)	11 ... 25 / 0.5
Supply voltage for gauge	V / A (dc)	20 ... 28 / 0.8
Connector for DeviceNet		Microstyle, 5 pin
Connector for BCG (analog output, supply voltage, setpoints)		D-sub, 15-pin, male

TripleGauge BCG450 (continued)

Dimensions

mm (in.)

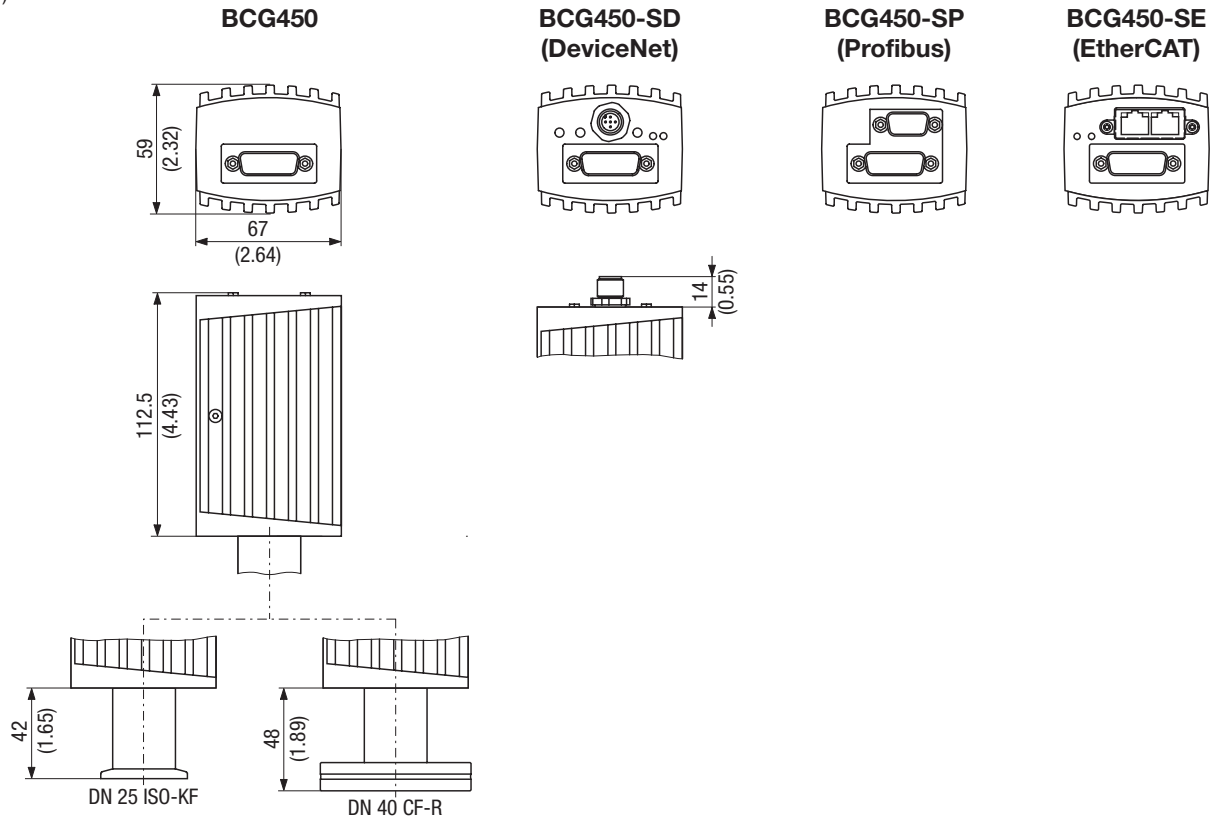

Accessories

Power supply 24 V (dc) / RS 232 C line

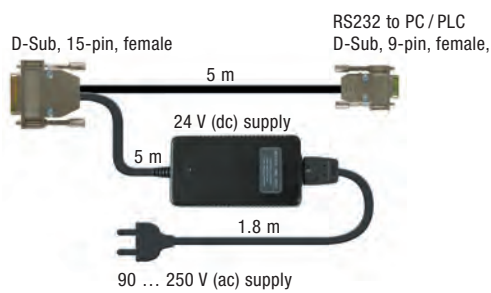

Baffle

Prevents contamination of the sensor.
Fast and easy installation.



Pirani Standard Gauge

PSG500/-S, PSG502-S, PSG510-S, PSG512-S

The INFICON Pirani Standard Gauges, PSG500, PSG502-S, PSG510-S and PSG512-S, employ the most advanced digital Pirani technology available in the marketplace. The rugged stainless steel sensor cell and compact design qualify them for use on semiconductor systems and for standard applications, such as fore vacuum lines.

Advantages

- Easy push button ATM and HV adjustment
- Space saving rugged design
- Aluminum housing
- Mounts in any orientation
- All stainless steel measuring cell
- Logarithmic signal output for easy integration
- 10 bar absolute overpressure with threaded connections
- 250°C bakeable version
- Nickel filament option for corrosive applications
- Ceramic feedthrough for extremely corrosive applications (PSG510 and PSG512)
- Optional setpoints
- RoHS compliance

Applications

- Controlling high vacuum ionization gauges
- Fore vacuum pressure monitoring
- Safety circuits in vacuum systems
- General vacuum measurement and control in the fine and rough vacuum range



PSG500/-S, PSG502-S, PSG510-S, PSG512-S (continued)

Ordering Information

Type Setpoints Filament	PSG500 None Tungsten	PSG500-S Two setpoints Tungsten	PSG502-S Two setpoints Nickel	PSG510-S Two setpoints Tungsten	PSG512-S Two setpoints Nickel
DN 16 ISO-KF	350-060	350-080	350-140	350-200	350-300
DN 16 CF-R	350-062	350-082	350-142		
1/8 in. NPT	350-061	350-081	350-141		
8 VCR	350-064	350-084	350-144		
4 VCR	350-065	350-085	350-145		
1/2 in. tube	350-063	350-083	350-143		
7/16-20 UNF	350-066	350-086	350-146		
DN 16 ISO-KF long tube	350-067	350-087	350-147		
DN 16 CF-R long tube	350-068	350-088	350-148		

Replacement sensor

Filament	Tungsten	Nickel	Tungsten	Nickel
DN 16 ISO-KF	350-920	350-900	350-930	350-940
DN 16 CF-R	350-922	350-902		
1/8 in. NPT	350-921	350-901		
8 VCR	350-924	350-904		
4 VCR	350-926	350-906		
1/2 in. tube	350-923	350-903		
7/16-20 UNF	350-925	350-905		
DN 16 ISO-KF long tube	350-927	350-907		
DN 16 CF-R long tube	350-928	350-908		

PSG500/-S, PSG502-S, PSG510-S, PSG512-S (continued)

Specifications

Type	PSG500	PSG500-S	PSG502-S	PSG510-S	PSG512-S
Filament	Tungsten	Tungsten	Nickel	Tungsten	Nickel
Measuring principle	thermal conductance according to Pirani				
Measurement range (air, O ₂ , CO, N ₂)	mbar	5 x 10 ⁻⁴ to 1000			
Accuracy (N ₂)	1 x 10 ⁻³ ... 100 mbar	% of reading ±15%			
	5 x 10 ⁻⁴ ... 1 x 10 ⁻³ mbar	% of reading ±50%			
	100 ... 1000 mbar	% of reading ±50%			
Repeatability (air)	1 x 10 ⁻³ ... 100 mbar	% of reading 2%			
Output signal (measurement signal)					
Voltage range	V	0 ... +10.3			
Measurement range	V	+1.9 ... +10.0			
Voltage vs. pressure		Logarithmic 1.286 V/decade			
Error signal	V	0 ... +0.5 (filament rupture)			
Output impedance	Ω	2 x 4.7			
Minimum loaded impedance	kΩ	10, short-circuit proof			
Response time	ms	80			
Gauge identification	kΩ	27.0, referenced to supply common			
Adjustment	One tactile switch for ATM and HV adjustment				
Setpoint	none	2			
Setting range	mbar	2 x 10 ⁻³ ... 500			
Hysteresis	% of reading	10% above lower threshold			
Relay contact	V (dc) / A (dc)	30 / 0.5 floating			
Switching time	ms	<20			
Supply voltage					
At gauge	V (dc)	+14 ... +30			
Ripple	V _{pp}	≤1			
Current consumption	mA	<500 (max. starting current)			
Power consumption	W	≤1			
Electrical connection	FCC 68 / RJ45 appliance connector, 8 poles, male				
Sensor cable	8 poles plus shielding				
Cable length	m	≤100 (8 x 0.14 mm ²)			
Materials exposed to vacuum	Glass, Ni, NiFe				Al ₂ O ₃ , Ni,
Filament	W	W	Ni	W	Ni
Internal volume					
DN 16 ISO-KF, DN 16 CF-R, 7/16-20 UNF	cm ³ (in. ³)	1.5 (0.092)			
DN 16 ISO-KF and DN 16 CF-R long tube	cm ³ (in. ³)	10 (0.61)			
1/8 in. NPT, 4 VCR, 8 VCR, 1/2 in. tube	cm ³ (in. ³)	2 (0.122)			
Admissible pressure	bar (absolute)	10, limited to inert gases			
Admissible temperature					
Operation	°C	+5 ... +60			
Vacuum connection ¹⁾	°C	80 / 250 ²⁾			
Storage	°C	-20 ... +65			
Mounting orientation	any				
Degree of protection	IP40				
Weight					
DN 16 ISO-KF, 7/16-20 UNF	g	80			
DN 16 CF-R, 4 VCR	g	100			
1/8 in. NPT, 1/2 in. tube	g	70			
8 VCR, DN 16 ISO-KF long tube	g	130			
DN 16 CF-R long tube	g	140			

¹⁾ In horizontal mounting orientation

²⁾ Long tube

PSG500/-S, PSG502-S, PSG510-S, PSG512-S (continued)

Dimensions

mm (in.)

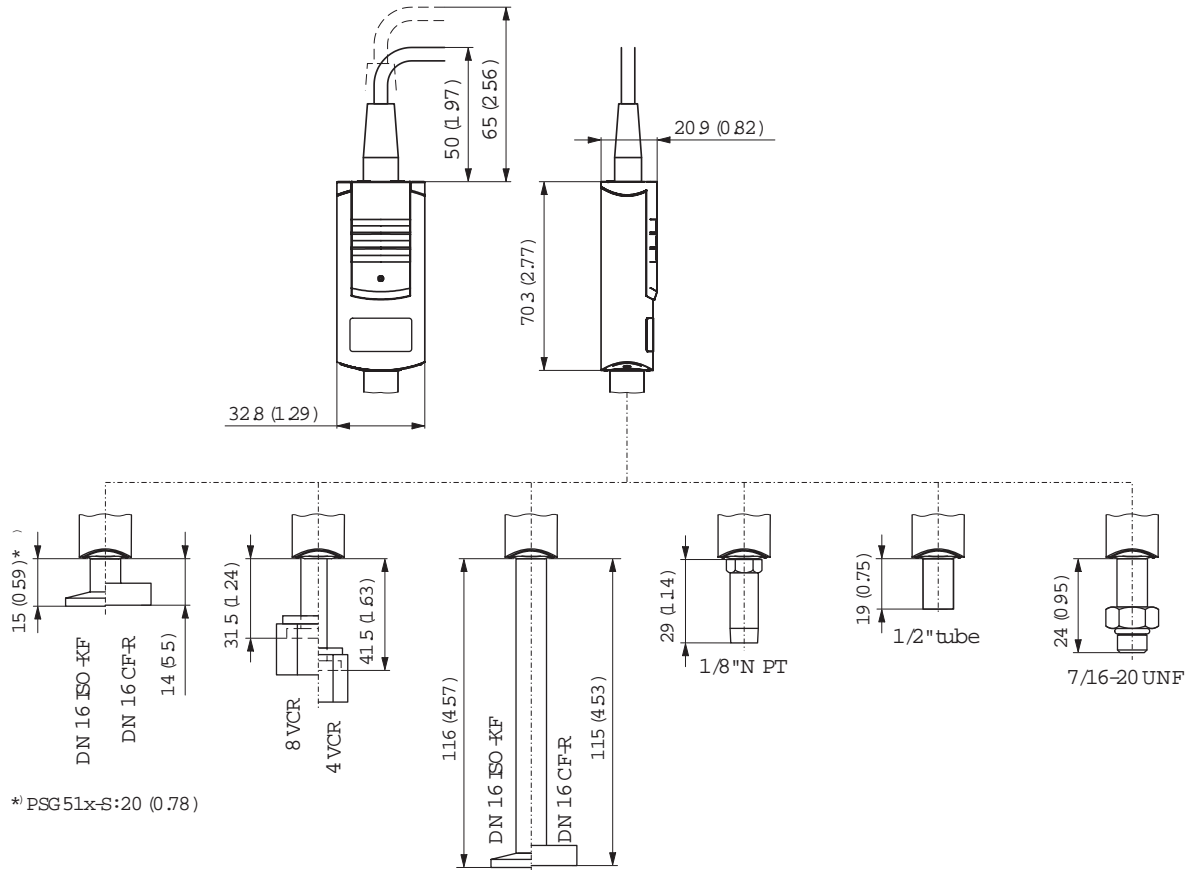

Pirani Standard Gauge

PSG550, PSG552, PSG554

The INFICON Pirani Standard Gauge (PSG55x) employs like his brothers PCG55x and PSG50x the most advanced digital Pirani technology available. The rugged sensor design combined with the compact size and the variety of features qualifies as the right product for measurement from low to the high vacuum range.

Advantages

- Available with Tungsten (PSG550) or nickel (PSG552) filament or with a fully ceramic coated (PSG554) sensor unit for highly corrosive applications
- Optional display, setpoints and digital interfaces, e.g. EtherCAT
- Easy to exchange plug and play sensor element with on-board calibration data—guarantees high reproducibility and low cost of ownership
- Selectable output signal and various plug versions for easy integration
- Mounts in any orientation—provides engineering freedom in tool design
- Diagnostic port on all versions
- Compliance and standards: CE, EN, UL, CSA, RoHS

Applications

- Fore vacuum pressure measurement
- Safety circuits in vacuum systems
- General vacuum measurement and control from low to the high vacuum range



PSG550, PSG552, PSG554 (continued)

Ordering Information

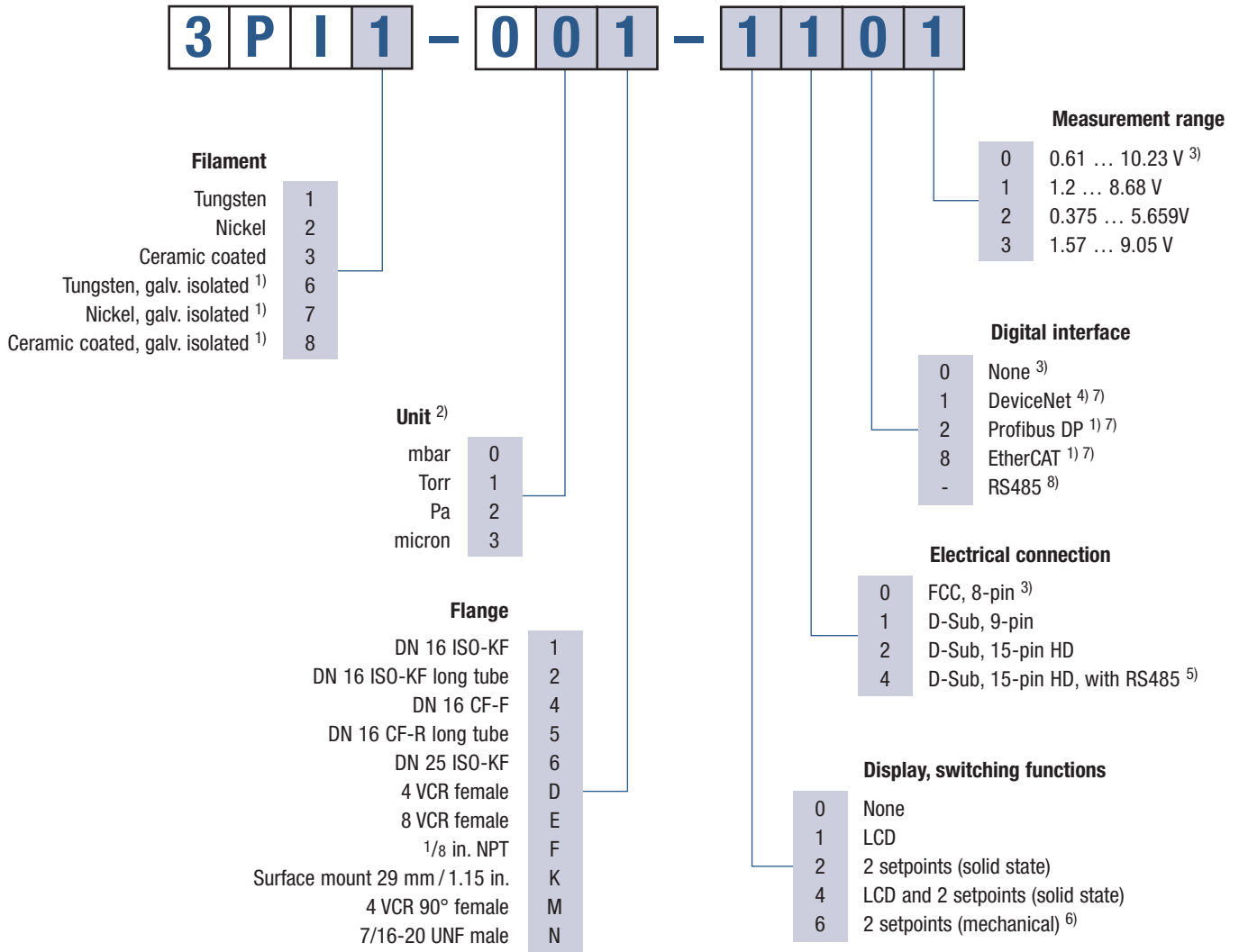

1) Only with D-Sub 9-pin connector available
 2) When selecting LCD (liquid crystal display) choose desired pressure unit
 3) Choose these settings when using an INFICON VGC40x or PGD400 controller or when choosing "4" under electrical connections
 4) Only with D-Sub 9-pin connector and galvanically isolated available
 5) Only without additional digital interface available
 6) Only with D-Sub 9-pin connector without LCD available
 7) Fieldbus options only available together with switching functions (select number "2" or "4" from table "Display, switching functions")
 8) Just selectable via number "4" from table "Electrical connection"

PSG550, PSG552, PSG554 (continued)

Specifications (continued)

Type	PSG550		PSG552		PSG554	
Filament	Tungsten		Nickel		Ceramic coated	
Measurement range	mbar (Torr)		5×10 ⁻⁵ ... 1000 (3.8×10 ⁻⁵ ... 750)			
Accuracy (N ₂)	5 x 10 ⁻⁴ ... 1 x 10 ⁻³ mbar	% of reading	±50			
	1 x 10 ⁻³ ... 100 mbar	% of reading	±15			
	100 ... 1000 mbar	% of reading	±50			
Repeatability (N ₂)	1 x 10 ⁻³ ... 100 mbar	% of reading	±2			
Admissible pressure	bar (absolute)		≤5			
Pressure, max.	bar (absolute)		10			
Admissible temperature						
Operation (ambient)	°C		+10 ... +50			
Storage	°C		-20 ... +65			
Bakeout at flange	°C		≤80			
Long tube	°C		≤250			
Supply voltage	V / A (dc)		+15 ... +30			
Power consumption						
Without fieldbus	W		≤2.5			
DeviceNet	W		≤3			
Profibus DP	W		≤3			
Output signal analog						
3Plx-0xx-xxx0	V		0 ... +10			
-xxx1	V		0 ... +8.5			
-xxx2	V		0 ... +5.529			
-xxx3	V		0 ... +8.875			
Measuring range						
3Plx-0xx-xxx0	V		+0.61 ... +10			
-xxx1	V		+1.2 ... +8.5			
-xxx2	V		+0.375 ... +5.529			
-xxx3	V		+1.57 ... +8.875			
Voltage vs. pressure						
3Plx-0xx-xxx0	V / Decade		1.286			
3Plx-0xx-xxx1 / -xxx2 / -xxx3	V / Decade		1			
Load impedance	kΩ		>10			
Setpoint relay			2			
Range (N ₂)	mbar		5 x 10 ⁻⁵ ... 1000			
Relay contact			n.o., potential free			
Hysteresis	% of threshold		10			
Contact rating						
Solid state relays	V / A (dc)		≤30 / ≤0.3			
Mechanical relays	V / A (dc)		≤30 / ≤1			
Switching time	ms		≤30			
Interface (digital)			RS232C			
Electrical connection						
3Plx-0xx-x0xx			FCC, 8-pin			
-x1xx			D-Sub, 9-pin, male			
-x2xx			D-Sub, 15-pin HD, male			
-x4xx			D-Sub, 15-pin HD, with RS485, male			
Cable length	m (ft.)		≤100 (≤330)			
RS232C operation	m (ft.)		≤30 (≤100)			
Materials exposed to vacuum	W, Ni, NiFe, glass, SnAg, stainless steel		Ni, NiFe, glass, SnAg, stainless steel		Al ₂ O ₃ , stainless steel	

(continued)

PSG550, PSG552, PSG554 (continued)

Specifications (continued)

Type Filament		PSG550 Tungsten	PSG552 Nickel	PSG554 Ceramic coated
Internal volume				
DN 16 ISO-KF	cm ³		4.7	
DN 16 ISO-KF long tube	cm ³		14.5	
DN 16 CF-F	cm ³		8	
DN 16 CF-R long tube	cm ³		14	
DN 25 ISO-KF, 4 VCR	cm ³		5.5	
8 VCR	cm ³		7	
1/8 in. NPT, 7/16-20 UNF	cm ³		5.2	
Surface mount 29 mm (1.15 in.)	cm ³		4.9	
4 VCR 90°	cm ³		7.9	
Weight				
Without fieldbus interface	g		115 ... 130	
With fieldbus interface	g		230 ... 250	
Degree of protection			IP 40	
Standards		EN 61000-6-2/-6-3, EN 61010, UL 61010-1, CSA 22.2 No. 61010-1		

Specifications (DeviceNet)

Protocol		DeviceNet, group 2 slave only	
Data rate switch	kBaud	125, 250, 500 or network programmable	
Cable length			
125 kbps	m (ft.)	500 (1650)	
250 kbps	m (ft.)	250 (825)	
500 kbps	m (ft.)	100 (330)	
MAC ID		Two switches (address 00 – 63) or network programmable	
Digital functions		Read pressure, select units: Torr, mbar, Pa, micron, counts Monitor gauge status, detailed alarm and warning information, Safe state allows definition of behavior in case of error	
Specification		DeviceNet "Vacuum Gauge Device Profile"	
Device type		"CG" for combination gauge	
I/O slave messaging		Polling only	
Supply voltage for DeviceNet			
3PI6- / 3PI7- / 3PI8-0xx-xxxx	V / A (dc)	+15 ... +30	
Power consumption			
3PI6- / 3PI7- / 3PI8-0xx-xxxx	W	≤3	
Connector for DeviceNet		Micro-Style, 5-pin, male	

Specifications (Profibus DP)

Baud rates	kBaud MBaud	9.6 / 19.2 / 93.75 / 187.5 / 500 1.5 / 12	
Address		Two switches (address 00 – 127) or network programmable	
Digital functions		Read pressure, select units: Torr, mbar, Pa, micron, counts Monitor gauge status, detailed alarm and warning information, Safe state allows definition of behavior in case of error	
Connector for Profibus DP		D-Sub, 9-pin, female	

PSG550, PSG552, PSG554 (continued)

Specifications (EtherCAT)

		PSG55x EtherCAT
Protocol		EtherCAT
Communication standard		ETG.5003 Part 1 ¹⁾ ETG.5003 Part 2080 ²⁾
Node address		Explicit Device Identification
Physical layer		100BASE-Tx (IEEE 802.3)
Digital functions		Read pressure, select units: Torr, mbar, Pa, micron, counts monitor gauge status, detailed alarm and warning information, safe state allows definition of behavior in case of error
EtherCAT connector		2 x RJ45, 8-pin (socket), input and output
Cable		Special Ethernet Patch Cable or Crossover Cable, shielded (CAT5e quality or higher)
Cable length	m (ft)	≤100 (330)
Process data		Fixed PDO mapping and configurable PDO mapping
Mailbox (CoE)		SDO requests, responses and information

¹⁾ Semiconductor Device Profile

²⁾ Specific Device Profile: Vacuum Pressure Gauge

Specifications (RS485C)

Baud rates	kBaud	9.6 / 19.2 / 38.4 / 57.6
Address		Two switches (address 00 – 255)
Digital functions		Read pressure, select units: Torr, mbar, Pa, micron, counts monitor gauge status, detailed alarm and warning information, safe state allows definition of behavior in case of error
Connector for RS485		D-Sub, 15-pin HD, male

Spare Parts

Type		PSG550 Tungsten	PSG552 Nickel	PSG554 Ceramic coated
Replacement sensor	DN 16 ISO-KF	355-925	355-936	355-947
	DN 16 ISO-KF long tube	355-926	355-937	355-948
	DN 16 CF-F	355-927	355-938	355-949
	DN 16 CF-R long tube	355-928	355-939	355-950
	DN 25 ISO-KF	355-929	355-940	355-951
	4 VCR female	355-932	355-943	355-954
	8 VCR female	355-931	355-942	355-953
	1/8 in. NPT	355-930	355-941	355-952
	Surface mount 29 mm (1.15 in.)	355-934	355-945	355-956
	4 VCR 90° female	355-935	355-946	355-957
	7/16-20 UNF male	355-933	355-944	355-955

PSG550, PSG552, PSG554 (continued)

Accessories

Centering ring with filter (DN 16 ISO-KF)	211-097
Diagnostic: ¹⁾ Communication adapter (2 m) for PC RS232C serial port	303-333

¹⁾ Software to run the diagnostic functions on Windows NT, XP can be downloaded from our website.

Dimensions

mm (in.)

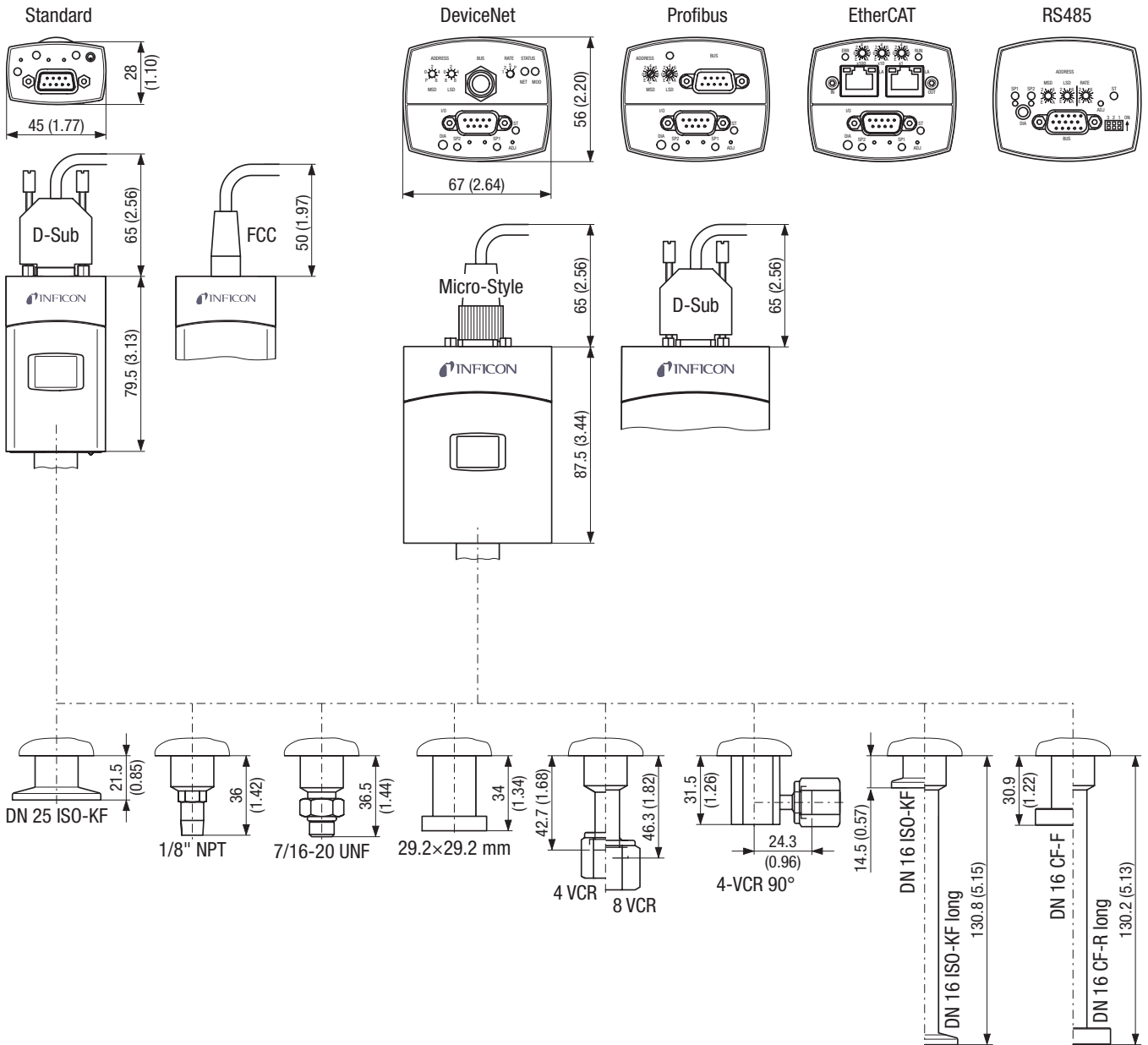

Pirani Capacitance Diaphragm Gauge

PCG550, PCG552, PCG554

The INFICON Pirani Capacitance Diaphragm Gauge (PCG55x) combines the INFICON Pirani technology with the advantages of a ceramic capacitance diaphragm sensor in a single product.

In the measurement range between 10 mbar and atmosphere the capacitance diaphragm technology provides gas-type independent, highly accurate values for reliable pressure measurement. The PCG55x offers also a variety of features which allows the right product configuration for the demanded application.



Advantages

- Gas-type independent above 10 mbar—allows safe venting with any gas mixture
- High accuracy and reproducibility at atmosphere—for reliable atmospheric pressure detection
- Fast atmospheric detection—eliminates waiting time and shortens process cycle
- Versatile of mounting orientation—provides engineering freedom in tool design
- Available with Tungsten (PCG550) or nickel (PCG552) filament or with a fully ceramic coated (PCG554) sensor unit for highly corrosive applications
- Easy to exchange plug and play sensor element with on-board calibration data—guarantees high reproducibility and low cost of ownership
- Selectable output signal for easy integration
- Optional atmospheric switch, display and digital interfaces e.g. EtherCAT
- Diagnostic port on all versions
- Compliance and standards: CE, EN, UL, CSA, RoHS

Applications

- Load Lock control
- Fore vacuum pressure measurement
- Safety circuits in vacuum systems
- General vacuum measurement and control in the medium and rough vacuum range

PCG550, PCG552, PCG554 (continued)

Ordering Information

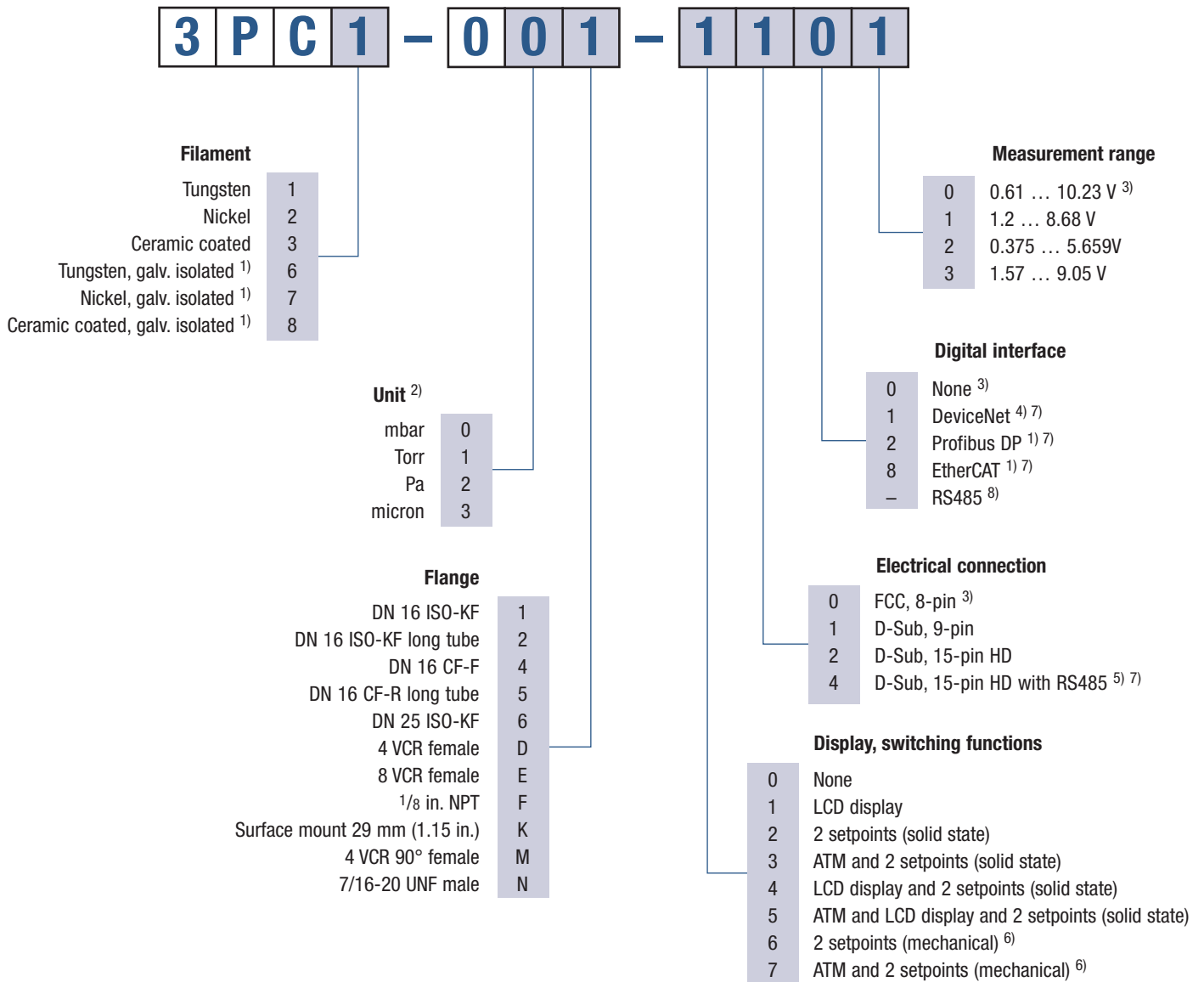

- ¹⁾ Only with D-Sub 9-pin connector available
- ²⁾ When selecting LCD (liquid crystal display) choose desired pressure unit
- ³⁾ Choose these settings when using the INFICON VGC40x/PGD controllers or if selecting "4" under electrical connections
- ⁴⁾ Only with D-Sub 9-pin connector and galvanically isolated available
- ⁵⁾ Only without additional digital interface available
- ⁶⁾ Only with D-Sub 9-pin connector without LCD display available
- ⁷⁾ Fieldbus options only available together with switching functions (select number "2", "3", "4", or "5" from table "Display, switching functions")
- ⁸⁾ Just selectable via number "4" from table "Electrical connection."

PCG550, PCG552, PCG554 (continued)

Specifications

Type Filament	PCG550 Tungsten	PCG552 Nickel	PCG554 Ceramic coated
Measurement range	mbar (Torr) 5 x 10 ⁻⁵ ... 1500 (3.8 x 10 ⁻⁵ ... 1125)		
Accuracy	5 x 10 ⁻⁴ ... 1 x 10 ⁻³ mbar (N ₂)	% of reading	±50
	1 x 10 ⁻³ ... 100 mbar (N ₂)	% of reading	±15
	100 ... 950 mbar	% of reading	±5
	950 ... 1050 mbar	% of reading	±2.5
Repeatability	1 x 10 ⁻³ ... 1100 mbar (N ₂)	% of reading	±2
Admissible pressure	bar (absolute) ≤5		
Pressure, max.	bar (absolute) ≥10		
Admissible temperature			
Operation (ambient)	°C	+10 ... +50	
Storage	°C	-20 ... +65	
Bakeout at flange	°C	≤80	
Long tube	°C	≤250	
Supply voltage	V / A (dc)		+15 ... +30
Power consumption			
Without fieldbus	W	≤2.5	
DeviceNet	W	≤3	
Profibus DP	W	≤3	
Output signal analog			
3PCx-0xx-xxx0	V	0 ... +10.23	
-xxx1	V	0 ... +8.68	
-xxx2	V	0 ... +5.659	
-xxx3	V	0 ... +9.05	
Measuring range			
3PCx-0xx-xxx0	V	+0.61 ... +10.23	
-xxx1	V	+1.2 ... +8.68	
-xxx2	V	+0.375 ... +5.659	
-xxx3	V	+1.57 ... +9.05	
Voltage vs. pressure			
3PCx-0xx-xxx0	V / Decade	1.286	
3PCx-0xx-xxx1 / -xxx2 / -xxx3	V / Decade	1	
Load impedance	kΩ		>10
Setpoint relay	2		
Range (N ₂)	mbar		5 x 10 ⁻⁵ ... 1500
Relay contact	n.o., potential free		
Hysteresis	% of threshold		10
Contact rating			
Solid state relays	V / A (dc)		≤30 / ≤0.3
Mechanical relays	V / A (dc)		≤30 / ≤1
Switching time	ms		≤30
Interface (digital)	RS232C		
Electrical connection			
3PCx-0xx-x0xx	FCC, 8-pin		
-x1xx	D-Sub, 9-pin, male		
-x2xx	D-Sub, 15-pin HD, male		
-x4xx	D-Sub, 15-pin HD with RS485, male		
Cable length	m (ft.)		≤100 (≤330)
RS232C operation	m (ft.)		≤30 (≤100)

(continued)

PCG550, PCG552, PCG554 (continued)

Specifications (concluded)

Type Filament	PCG550 Tungsten	PCG552 Nickel	PCG554 Ceramic coated
Materials exposed to vacuum	W, Ni, NiFe, Al ₂ O ₃ , SnAg, stainless steel, glass	Ni, NiFe, Al ₂ O ₃ , SnAg, stainless steel, glass	Al ₂ O ₃ , stainless steel
Internal volume			
DN 16 ISO-KF	cm ³	4.7	
DN 16 ISO-KF long tube	cm ³	14.5	
DN 16 CF-F	cm ³	8	
DN 16 CF-R long tube	cm ³	14	
DN 25 ISO-KF, 4 VCR	cm ³	5.5	
8 VCR	cm ³	7	
1/8 in. NPT, 7/16-20 UNF	cm ³	5.2	
Surface mount 29 mm (1.15 in.)	cm ³	4.9	
4 VCR 90°	cm ³	7.9	
Weight			
Without fieldbus interface	g	115 ... 130	
With fieldbus interface	g	230 ... 250	
Degree of protection		IP 40	
Standards	EN 61000-6-2/-6-3, EN 61010, UL 61010-1, CSA 22.2 No. 61010-1		

Specifications (DeviceNet)

Protocol		DeviceNet, group 2 slave only
Data rate switch	kBaud	125, 250, 500 or network programmable
Cable length		
125 kbps	m (ft.)	500 (1650)
250 kbps	m (ft.)	250 (825)
500 kbps	m (ft.)	100 (330)
MAC ID		Two switches (address 00 – 63) or network programmable
Digital functions		Read pressure, select units: Torr, mbar, Pa, micron, counts monitor gauge status, detailed alarm and warning information, safe state allows definition of behavior in case of error
Specification		DeviceNet "Vacuum Gauge Device Profile"
Device type		"CG" for combination gauge
I/O slave messaging		Polling only
Supply voltage for DeviceNet		
3PC6- / 3PC7- / 3PC8-0xx-xxxx	V / A (dc)	+15 ... +30
Power consumption		
3PC6- / 3PC7- / 3PC8-0xx-xxxx	W	≤3
Connector for DeviceNet		Micro-Style, 5-pin, male

Specifications (Profibus DP)

Baud rates	kBaud	9.6 / 19.2 / 93.75 / 187.5 / 500
	MBaud	1.5 / 12
Address		Two switches (address 00 – 127) or network programmable
Digital functions		Read pressure, select units: Torr, mbar, Pa, micron, counts monitor gauge status, detailed alarm and warning information, safe state allows definition of behavior in case of error
Connector for Profibus DP		D-Sub, 9-pin, female

PCG550, PCG552, PCG554 (continued)

Specifications (EtherCAT)

		PCG55x EtherCAT
Protocol		EtherCAT
Communication standard		ETG.5003 Part 1 ¹⁾ ETG.5003 Part 2080 ²⁾
Node address		Explicit Device Identification
Physical layer		100BASE-Tx (IEEE 802.3)
Digital functions		Read pressure, select units: Torr, mbar, Pa, micron, counts monitor gauge status, detailed alarm and warning information, safe state allows definition of behavior in case of error
EtherCAT connector		2 × RJ45, 8-pin (socket), input and output
Cable		special Ethernet Patch Cable or Crossover Cable, shielded (CAT5e quality or higher)
Cable length	m (ft)	≤100 (330)
Process data		fixed PDO mapping and configurable PDO mapping
Mailbox (CoE)		SDO requests, responses and information

¹⁾ Semiconductor Device Profile

²⁾ Specific Device Profile: Vacuum Pressure Gauge

Specifications (RS485C)

Baud rates	kBaud	9.6 / 19.2 / 38.4 / 57.6
Address		Two switches (address 00 – 255)
Digital functions		Read pressure, select units: Torr, mbar, Pa, micron, counts monitor gauge status, detailed alarm and warning information, safe state allows definition of behavior in case of error
Connector for RS485		D-Sub, 15-pin HD, male

Spare Parts

Type		PCG550	PCG552	PCG554
Filament		Tungsten	Nickel	Ceramic coated
Replacement sensor	DN 16 ISO-KF	357-925	357-936	357-947
	DN 16 ISO-KF long tube	357-926	357-937	357-948
	DN 16 CF-F	357-927	357-938	357-949
	DN 16 CF-R long tube	357-928	357-939	357-950
	DN 25 ISO-KF	357-929	357-940	357-951
	4 VCR female	357-932	357-943	357-954
	8 VCR female	357-931	357-942	357-953
	1/8 in. NPT	357-930	357-941	357-952
	Surface mount 29 mm (1.15 in.)	357-934	357-945	357-956
	4 VCR 90° female	357-935	357-946	357-957
	7/16-20 UNF male	357-933	357-944	357-955

Accessories

Centering ring with filter (DN 16 ISO-KF)	211-097
Diagnostic: ¹⁾ Communication adapter (2 m) for PC RS232C serial port	303-333

¹⁾ Software to run the diagnostic functions on Windows NT, XP can be downloaded from our website.

PCG550, PCG552, PCG554 (continued)

Dimensions, Internal Volume, Weight

mm (in.)

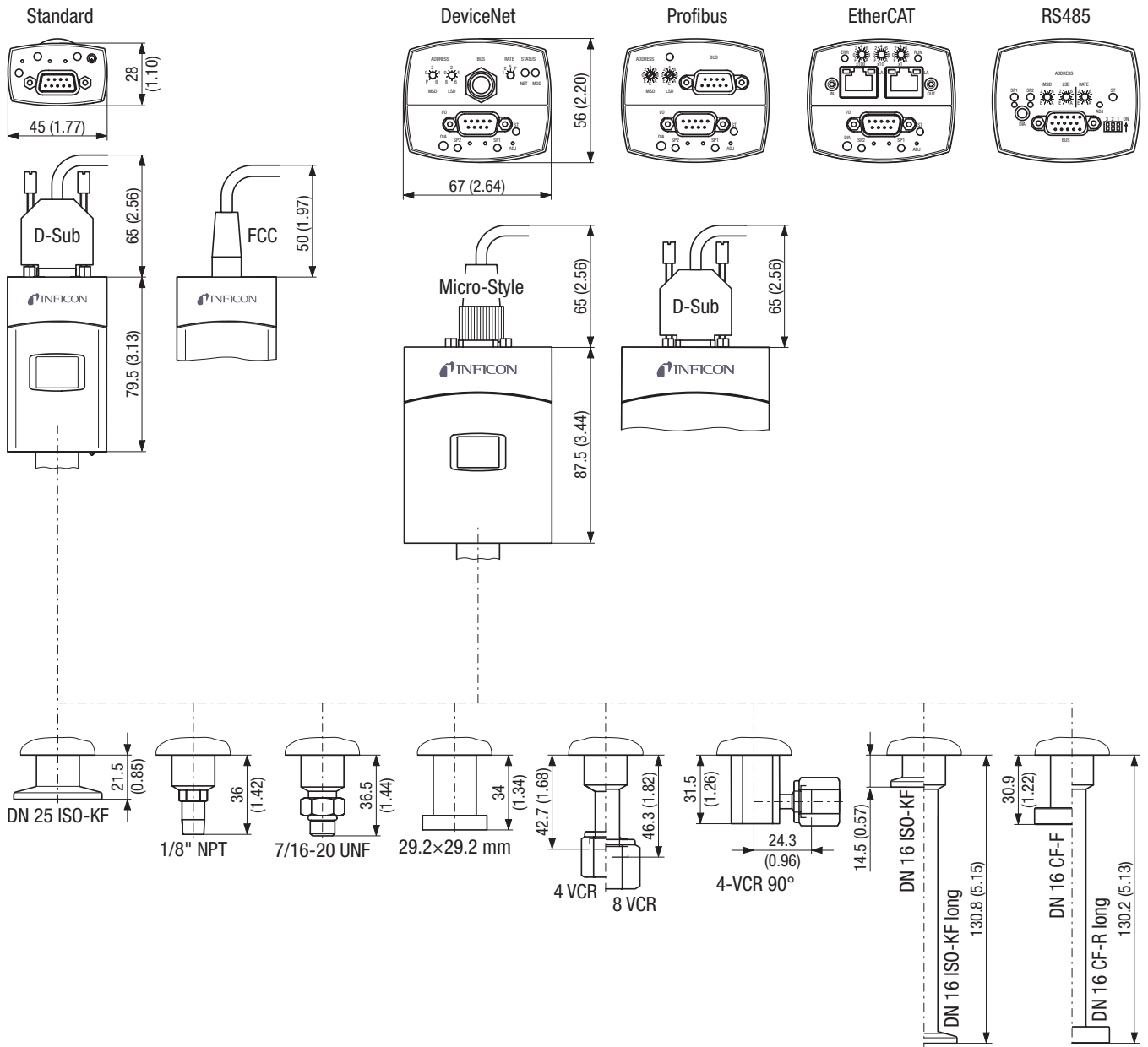

Penning Gauge

PEG100

The INFICON Penning Gauge PEG100 provides reliable high vacuum measurements. The rugged Penning cold cathode sensor has no filament to burn out. Due to titanium cathode plates and the reduced high voltage after plasma ignition, the gauge can be operated also in sputtering applications. The fieldbus options, in addition to the logarithmic analog output signal, allow easy integration into vacuum systems using Profibus DP or DeviceNet protocols.

Advantages

- Wide measurement range from 1×10^{-9} mbar to 1×10^{-2} mbar (7.5×10^{-10} Torr to 7.5×10^{-3} Torr)
- All-metal cold cathode sensor (Penning) with ceramic feedthrough
- Innovative electrode geometry provides excellent ignition properties
- Decreased high voltage after plasma ignition and titanium cathode plates reduce risk of contamination, even during sputtering operations with argon
- The anode ring and the titanium cathode can be cleaned or replaced easily
- Minimal magnetic field intensity adjacent to gauge
- LED indicator for power on and plasma ignited
- Logarithmic analog output signal
- Fieldbus interface (Profibus DB, DeviceNet) for easy integration into vacuum systems using network communications



Applications

- High vacuum pressure monitoring
- Evaporation and sputtering systems
- General vacuum measurement and control in the fine and high vacuum range

Ordering Information

Type	PEG100	PEG100-D with DeviceNet	PEG100-P with Profibus DP
DN 25 ISO-KF	351-000	351-003	351-005
DN 40 CF-F	351-002	351-004	—
Replacement cathode plates, titanium Set of five pieces	351-490	351-490	351-490

PEG100 (continued)

Specifications

PEG100			
Measurement range	mbar		1×10^{-9} to 1×10^{-2}
	Torr		7.5×10^{-10} to 7.5×10^{-3}
Accuracy	10^{-8} to 10^{-4} mbar	% of reading	±30
Pressure, max. (absolute)		bar	10
Temperature			
Operation (ambient)		°C	+10 to +50
Storage		°C	-20 to +75
Bakeout			
without electronics		°C	350
with electronics, at flange		°C	70
Supply			
Voltage	V (dc)		14.5 to 36
Consumption, max.	W		<2
Output signal analog	V		0 to 10.6
Measurement range	V		0.66 to 10
Relation voltage / pressure	V / Decade		1.333
Connector			FCC 68, female, 8 pin (shielded)
Cable length, max. (analog)	m (ft.)		100 (330)
Materials exposed to vacuum			Stainless steel, CrNi, Al ₂ O ₃ , NiFe, Mo, Cu, Ni, Ti
Internal volume	cm ³ (in. ³)		21 (1.28)
Weight, approx.	g		500
Protection type			IP40

Specifications (DeviceNet)

PEG100-D DeviceNet			
Device type			generic
Explicit peer to peer messaging			no
I/O peer to peer messaging			no
Configuration consistency value			no
Faulted node recovery			no
Baud rates	kBaud		125 / 250 / 500
Master / Scanner			no
I/O slave messaging			
Bit Strobe			yes
Polling			yes
Cyclic			yes
Change of State (COS)			yes
Supply for DeviceNet	V (dc)		11 to 25
Connector for DeviceNet			Phoenix Combicon, 5 pin

Specifications (Profibus DP)

PEG100-P Profibus DP			
Supported baud rates (auto detection)	kBaud		9.6 / 19.2 / 93.75 / 187.5 / 500 / 1500
Expanded user parameter data	Bytes		5
Configuring			
Number of input and output data			2
Sync-Mode and Freeze-Mode			Yes
Connector			D-sub, 9 pin

PEG100 (continued)

Spareparts

Type	PEG100
Spare Cathode Plate, set of 5 pcs	351-490

Dimensions

mm (in.)

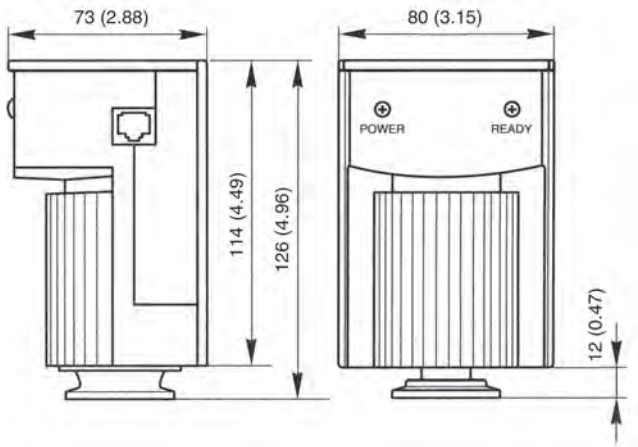

Inverted Magnetron Inverted Magnetron Pirani Gauge

Gemini MAG/MPG500, MAG/MPG504

The INFICON Gemini sensor MAG500 is just a purely cold cathode gauge while his twin MPG500 combines two sensor systems (cold cathode and Pirani) in the same housing. The MPG500 measures from atmosphere to 1×10^{-9} mbar. The patented ultra-low magnetic stray field design in both gauges gives opportunities in existing and new applications. A unique interchangeable dual chamber sensor unit reduces maintenance cycles and time. This is making Gemini the most robust and economical vacuum sensor of its kind.

Gemini Cold Cathode and combination sensor's comes with fully integrated digital electronics, providing ultimate flexibility for system integration. Both cold cathode and Pirani combination sensor option provide seamless transition, reliability, poractivity and flexibility across wide ranging applications.



Advantages

- Long lifetime in harsh environments
- Reliable fast ignition
- Low magnetic stray field
- Selectable measuring current
- Fast maintenance - replaceable insert
- Corrosion proof feedthrough
- Digital interface RS 232/485

Applications

- Base pressure monitoring and control, from atmosphere to high vacuum in evaporation and sputter coating applications.
- General vacuum measurement – industrial furnaces, architectural glass, semiconductor, production laboratory's..
- Analytical and R&D applications – mass spectrometry, electron microscopes, ophthalmic, optical, medical and high energy physics.

Gemini MAG/MPG500, MAG/MPG504 (continued)

Ordering Information

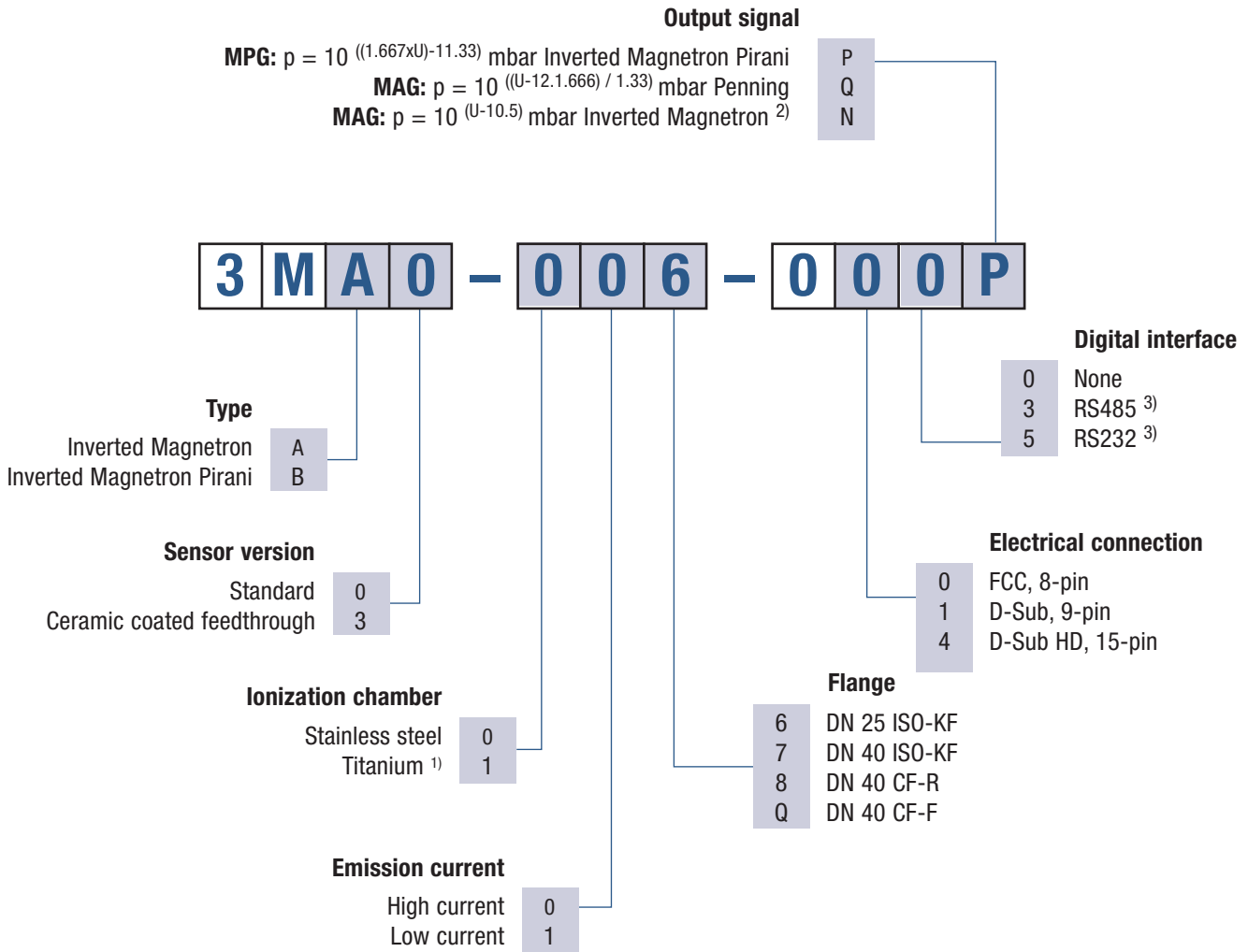

¹⁾ For low current version only.

²⁾ Not suited for operation with an INFICON vacuum gauge controller VGC40x or VGC50x.

³⁾ Digital interfaces only available with D-Sub HD, 15-pin connection (select number "4" from table "Electrical connection") to select 3 & 5 from "Digital interfaces"

Gemini MAG/MPG500, MAG/MPG504 (continued)

Specifications

Type	MAG50x		MPG50x
Measurement system	Cold Cathode ionization measurement system (according to the inverted magnetron principle)		Pirani and Cold Cathode ionization measurement system (according to the inverted magnetron principle)
Measurement range (air, N ₂)			
mbar	1 x 10 ⁻⁹ ... 1 x 10 ⁻²		1 x 10 ⁻⁹ ... 1000
Torr	7.6 x 10 ⁻¹⁰ ... 7.6 x 10 ⁻³		7.6 x 10 ⁻¹⁰ ... 760
Accuracy (N ₂)			
1 x 10 ⁻⁸ ... 1x10 ⁻² mbar	% of reading	30	–
1 x 10 ⁻⁸ ... 100 mbar	% of reading	–	30
100 ... 1000 mbar	% of reading	–	50
Repeatability (N ₂)			
1 x 10 ⁻⁸ ... 1 x 10 ⁻² mbar	% of reading	5	–
1 x 10 ⁻⁸ ... 100 mbar	% of reading	–	5
Mounting orientation	any		
Admissible pressure	bar (absolute)	10 (limited to inert gases <55°C)	
Admissible temperature			
Operation (ambient)	°C	+5 ... +55	
Bakeout at flange ¹⁾	°C	≤150	
Storage	°C	–40 ... +70	
Filament temperature	°C	–	120
Relative humidity for 30 days a year			
1 x 10 ⁻⁷ 1 x 10 ⁻² mbar	% RH	≤95 (non-condensing)	
1 x 10 ⁻⁸ 1 x 10 ⁻² mbar	% RH	≤70 (non-condensing)	
Supply voltage			
At gauge ²⁾	V (dc)	+14.5 ... +30	
Ripple	V _{pp}	≤1	
Power consumption	W	≤2	
Fuse to be connected	AT	≤1	
Voltage range (analog output)	V	0 ... +10.5	
Measurement range			
3MAx-0xx-0x0N	V	+1.5 ... +8.5	–
3MBx-0xx-0x0Q	V	+0.667 ... +10	–
3MAx-0xx-0x0P	V	–	+1.398 ... +8.598
Voltage vs. pressure			
3MAx-0xx-0x0N	V/decade	1 (logarithmic)	–
3MBx-0xx-0x0Q	V/decade	1.33 (logarithmic)	–
3MAx-0xx-0x0P	V/decade	–	0.6 (logarithmic)
Error signal			
3MAx-0xx-0x0N	V	<+0.5	–
3MBx-0xx-0x0Q	V	≤+0.3	–
3MAx-0xx-0x0P	V	–	+9.5 ... +10.5
Output impedance	Ω	2 x 4.7 (short circuit-proof)	
Load impedance	kΩ	≥10 (short circuit-proof)	
Step response time			
p > 10 ⁻⁶ mbar	ms	<100	
p = 10 ⁻⁸ mbar	s	≈1	

Gemini MAG/MPG500, MAG/MPG504 (continued)

Specifications

Type		MAG50x	MPG50x
Gauge identification			
3MAx-0xx-0x0N	kΩ	–	–
3MBx-0xx-0x0Q	kΩ	100	–
3MAx-0xx-0x0P	kΩ	–	85
Status signal	V	+14.5 ... +30 (cold cathode ignited)	
Status (pin 6)			
Cold cathode ignited	V	+15 ... +30	–
Pirani-only mode	V	–	0 (low)
Combined Pirani / Cold Cathode	V	–	+15 ... +30 (high)
Electrical connection			
3Mxx-0xx-000x		FCC68, 8-pin, female	
3Mxx-0xx-010x		D-Sub, 9-pin, male	
3Mxx-0xx-040x		D-Sub, 15-pin HD, male	
Sensor cable			
3Mxx-0xx-000x		8-pin, shielded	
3Mxx-0xx-010x		9-pin, shielded	
3Mxx-0xx-040x		15-pin, shielded	
Cable length (FCC only)	m	≤50 (0.14 mm ² /conductor)	
High voltage (in the measuring chamber)			
Ignition voltage	kV	≤4.5	
Operating voltage	kV	≤3.3	
Current (in the measuring chamber)			
High current	μA	≤500	
Low current	μA	≤100	
Materials exposed to vacuum			
3Mx0-0xx-0x0x		Ni alloys, Mo, Al ₂ O ₃ , glass, stainless steels	W, Ni alloy, Mo, Al ₂ O ₃ , glass, stainless steels
3Mx3-0xx-0x0x		Mo, Al ₂ O ₃ , stainless steels	W, Mo, Al ₂ O ₃ , stainless steels
Internal volume			
DN 25 ISO-KF	cm ³	≈19.9	
DN 40 ISO-KF	cm ³	≈20.9	
DN 40 CF-F	cm ³	≈25.2	
DN 40 CF-R	cm ³	≈25.6	
Weight			
DN 25 ISO-KF	g	<280	
DN 40 ISO-KF	g	<320	
DN 40 CF-F & CF-R	g	<570	
Degree of protection		IP40	–
Standards			
CE conformity		EMC (EN 61000-6-2, EN61000-6-3), EN 61010-1 & RoHS	

¹⁾ Without electronics

²⁾ The minimum voltage of the supply unit must be increased proportionally to the length of the sensor cable

Gemini MAG/MPG500, MAG/MPG504 (continued)

Specifications

Baud rates	KBaud	9.6 / 19.2 / 38.4 / 57.6
Address		2 switches (address 00 - 255)
Digital functions		read pressure, select units: Torr, mbar, Pa, micron, counts monitor gauge status, detailed alarm and warning information, soft state allows definition of behaviour in case of error
Connector for RS485		D-Sub, 15-pin HD, male

Dimensions

mm (in.)

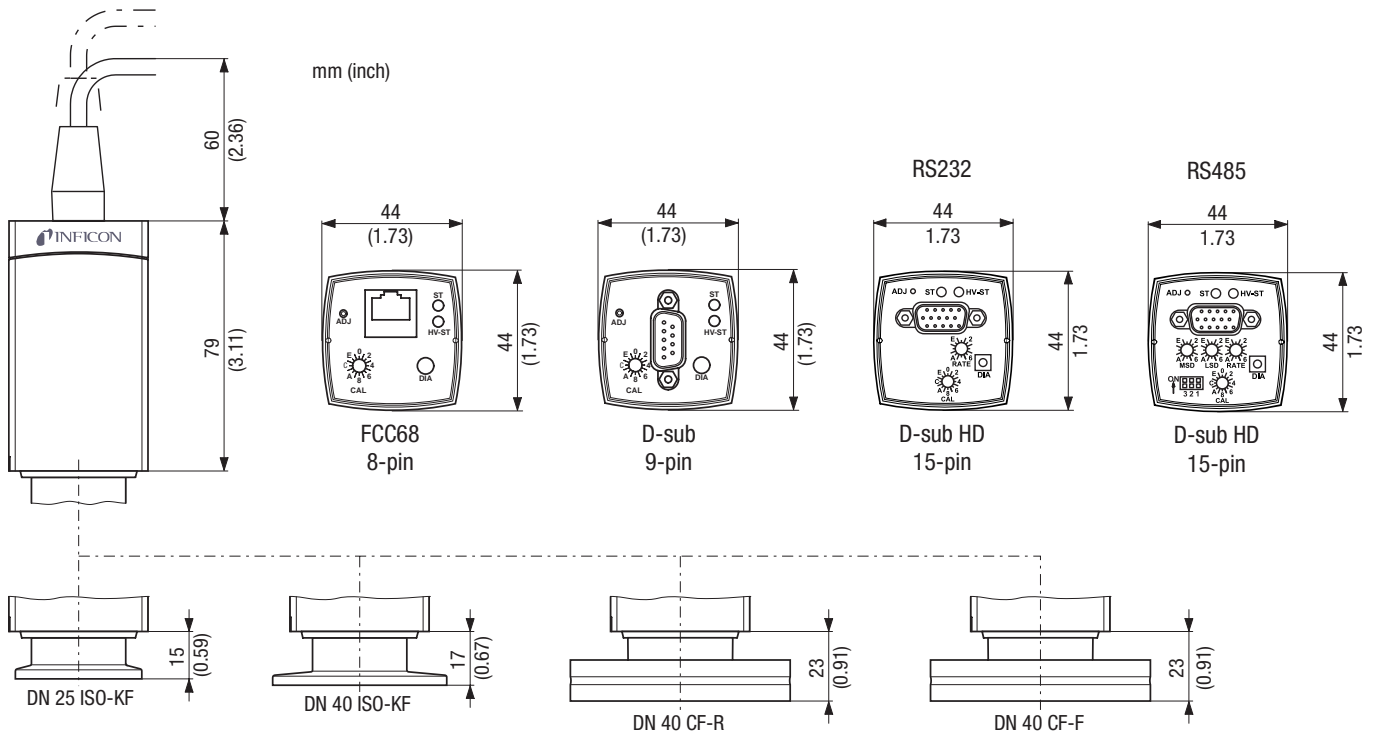

Inverted Magnetron Pirani Gauge

MPG400/401

The INFICON Inverted Magnetron Pirani Gauges, MPG400 and MPG401, measure from 5×10^{-9} mbar to atmosphere (3.8×10^{-9} Torr to atmosphere). Combining technologies into one single compact unit with one logarithmic analog out put signal significantly reduces the complexity of installation, setup and integration.



Advantages

- Combination gauge—inverted Magnetron and Pirani
- Wide measurement range from 5×10^{-9} mbar to atmosphere
- No filament to burn out
- Excellent ignition properties
- Easy to clean
- FPM or metal-sealed feedthrough
- LED indicator for high voltage on
- Logarithmic analog output signal

Applications

- High vacuum pressure monitoring
- Base pressure for evaporation and sputtering systems
- General vacuum measurement and control in the medium and high vacuum range

Ordering Information

Type	MPG400 FPM sealed	MPG401 Metal-sealed
DN 25 ISO-KF	351-010	351-020
DN 40 ISO-KF	351-011	351-021
DN 40 CF-F	351-012	351-022

Accessories

Type	MPG400 FPM sealed	MPG401 Metal-sealed
Magnetic shield	351-023	351-023

MPG400/401 – continued

Specifications

		MPG400 FPM sealed	MPG401 Metal-sealed
Measurement range (air, N ₂)	mbar (Torr)	5 x 10 ⁻⁹ ... 1000 (3.8 x 10 ⁻⁹ ... 760)	
Accuracy (N ₂)	1 x 10 ⁻⁸ ... 100 mbar % of reading	≈±30%	
Repeatability	1 x 10 ⁻⁸ ... 100 mbar % of reading	≈±5%	
Mounting orientation		any	
Admissible pressure	bar (absolute)	≤10 (limited to inert gases)	
Admissible temperature			
Operation (ambient)	°C	+5 ... +55	
Storage	°C	-40 ... +65	
Bake-out ¹⁾	°C	150	
Filament temperature (Pirani)	°C	120	
Supply voltage			
At gauge	V (dc)	+15 ... +30	
At supply unit with max. cable length ²⁾	V (dc)	+16 ... +30	
Ripple	V _{pp}	≤1	
Power consumption	W	≤2	
Fuse to be connected	AT	≤1	
Output signal (measurement signal)			
Voltage range	V	0 ... +10.5	
Measurement range	V	+1.82 ... +8.6	
Voltage vs. pressure		Logarithmic, 0.6 V/decade	
Error signal	V	<0.5 (no supply)	
	V	>9.5 (Pirani sensor, filament rupture)	
Output impedance	Ω	2 x 10	
Minimum loaded impedance	kΩ	10, short-circuit proof	
Response time	p > 10 ⁻⁶ mbar ms	<10	
	p = 10 ⁻⁸ mbar ms	≈1000	
Identification gauge	kΩ	85, referenced to supply common	
Status			
Pirani-only mode	V	0 (low)	
Combined Pirani / cold cathode mode	V	15 ... 30 (high)	
LED	LED green	high voltage on	
Electrical connection		FCC 68 appliance connector, 8 poles, female	
Sensor cable		8 poles plus shielding	
Cable length	m	≤50 (8 x 0.14 mm ²)	
Operating voltage	kV	≤3.3	
Operating current	μA	≤500	
Materials exposed to vacuum		Stainless steel, Al ₂ O ₃ , FPM75, Mo, Ni, Au, W	Stainless steel, Al ₂ O ₃ , Ag, Cu, Sn Mo, Ni, Au, W
Internal volume	cm ³	≈20	
Weight			
DN 25 ISO-KF	g	≈700	≈730
DN 40 ISO-KF	g	≈720	≈750
DN 40 CF-F	g	≈980	≈1010
Protection category		IP 40	
Standards		EN 61000-6-2, EN 61000-6-3, EN 61010-1	

¹⁾ Without electronics and magnetic shielding.

²⁾ The minimum voltage of the supply unit must be increased proportionally to the length of the sensor cable.

MPG400/401 – continued

Dimensions

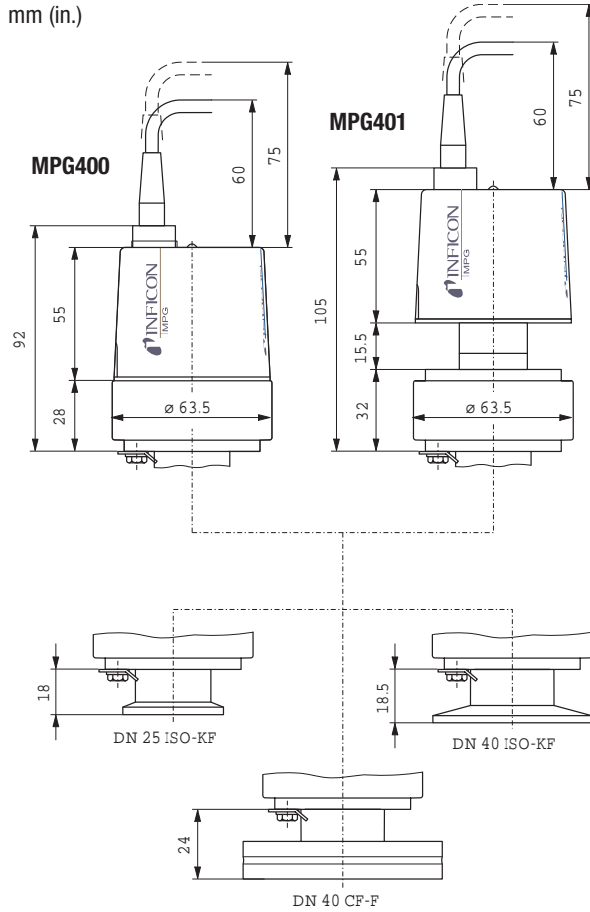

Spare Parts

Type	MPG400 FPM sealed	MPG401 Metal-sealed
Maintenance kit includes: support/centering ring seals ignition aid	351-999	351-997
Repair kit includes: Pirani element anode anode extension ¹⁾ Cu seal ¹⁾ screw fitting ¹⁾ support/centering ring seals ignition aid	351-998	351-996
Ignition aid kit includes: ignition aid	351-995	351-995
Mounting tool for ignition aid	351-994	351-994

¹⁾ MPG401 only

Vacuum Gauge Controller

VGC50x

Sustainable solution for process measurement, control and data log

Compatible to the wide range of INFICON active gauges, the new VGC50x series of active gauge controllers are able to monitor and data log the entire pressure range from 10^{-10} to 1500 mbar (10^{-10} to 1125 Torr) and the set point status.



Advantages

- Simple operation with dot matrix menu guided display for parameter, sensor or general settings
- Very bright and clear Display for long distance Instrument read-out
- Bar graph display with setpoints's or pressure vs. time display
- Data log and parameter log function with USB port (rear side) and USB stick (front side)
- Ethernet interface
- Firmware upgrade available online or with USB stick
- Two free definable setpoints per channel with adjustable hysteresis
- High Resolution - 16 bit A/D converter
- Automatic identification of the INFICON active gauges
- Programmable 0 to 10 V Chart Recorder Output with logarithmic/linear characteristics for single gauge or gauge combination (only VGC502 and VGC503)

Ordering Information

Type	VGC501	VGC502	VGC503
Vacuum Gauge Controller	398-481	398-482	398-483
Adapter rack mount 2HE / 3HE	398-499	-	-
Adapter USB to RS232	398-487	398-487	398-487

VGC50x (continued)

Accessories

Gauges	PCG, PEG, PSG, MAG, MPG, Porter	BCG, BPG, HPG, CDG-D	CDG (unheated)
Signal read out and communication	analog only	digital RS232 / analog	analog only
Cable connectors	FCC / FCC	D-Sub ¹⁾ / D-Sub ¹⁾	FCC / D-Sub ¹⁾
Cable to VGC50x in m (ft)			
3 (9.0)	398-500	398-520	398-540
5 (16.5)	398-501	398-521	398-541
10 (33.0)	398-502	398-522	398-542
15 (49.5)	398-503	398-523	398-543
20 (66.0)	398-504	398-524	398-544
30 (99.0)	398-505	398-525	398-545

Other lengths on request

¹⁾ D-Sub 15-pin

Specifications

Type	VGC501	VGC502	VGC503
Measurement channels	1	2	3
Display		LCD, LED backlight	
Rate	1/s	10	
Connectable gauges with display range			
CDG (A/D)	Torr	1 x 10 ⁻³ x F.S ... 1 x F.S	
PCG	Torr	3.75 x 10 ⁻⁴ ... 1125	
PSG	Torr	3.75 x 10 ⁻⁴ ... 750	
MPG	Torr	3.75 x 10 ⁻⁹ ... 750	
PEG	Torr	7.5 x 10 ⁻¹⁰ ... 7.5 x 10 ⁻³	
MAG	Torr	7.5 x 10 ⁻¹⁰ ... 7.5 x 10 ⁻³	
BCG	Torr	3.75 x 10 ⁻¹⁰ ... 1125	
BPG	Torr	3.75 x 10 ⁻¹⁰ ... 750	
HPG	Torr	1.5 x 10 ⁻⁶ ... 750	
Connectable gauges with display range			
PCG	mbar	5 x 10 ⁻⁴ ... 1500	
PSG	mbar	5 x 10 ⁻⁴ ... 1000	
MPG	mbar	1 x 10 ⁻⁹ ... 1000	
PEG	mbar	1 x 10 ⁻⁹ ... 1 x 10 ⁻²	
MAG	mbar	1 x 10 ⁻⁹ ... 1 x 10 ⁻²	
BCG	mbar	5 x 10 ⁻¹⁰ ... 1500	
BPG	mbar	5 x 10 ⁻¹⁰ ... 1000	
HPG	mbar	2 x 10 ⁻⁶ ... 1000	
Measurement unit (selectable)		mbar, Torr, Pa, hPa, Micron, V	
Setpoints			
Setpoint relays	2	4	6
Channel assignment	1	1 or 2	1, 2 or 3

VGC50x (continued)

Specifications

Type	VGC501		VGC502	VGC503
Setpoints				
Adjustment range			sensor dependent	
Hysteresis			adjustable	
Relay contact			floating changeover contact	
Connector	D-Sub, 15-pin, male		D-Sub, 25-pin, male	D-Sub, 25-pin, male
Contact rating	V (ac) · A		30 / 1	
	V (dc) · A		60 / 0.5	
Analog output				
Range	V		0 ... 10.3, sensor analog output signal	
Analog output		1	2	3
programmable analog output		-	1	1
Connector	D-Sub, 15-pin, male		D-Sub, 9-pin, male	D-Sub, 9-pin, male
Interface				
Connector	USB slave, master and Ethernet, USB Typ A (stick), USB Type B, FCC68/RJ45			
Power				
Supply	V (ac)		100 ... 240	
Frequency	Hz		50 ... 60	
Consumption	W	≤45	≤65	≤90
Operating temperature (ambience)	°C		+5 ... +50	

Dimensions

mm (in.)

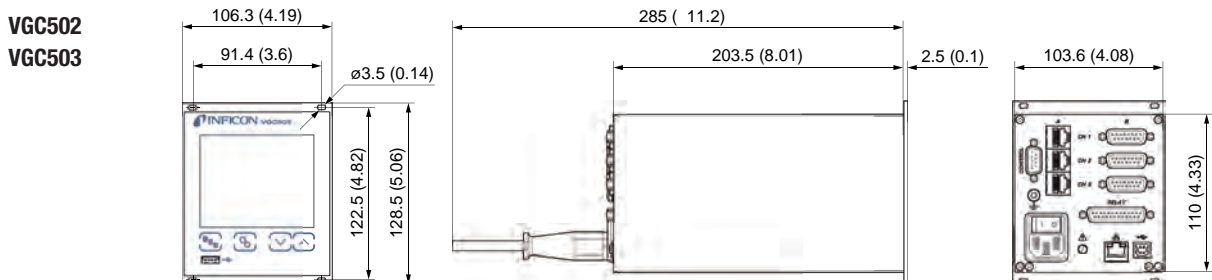
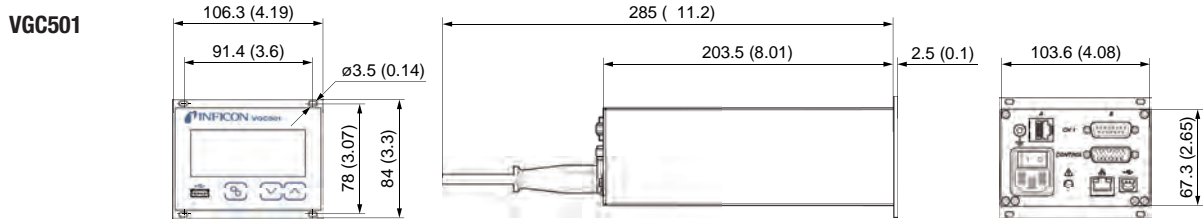

Pirani Gauge Display

PGD500

The INFICON Pirani Gauge Display PGD500 in combination with the INFICON Pirani Standard Gauge PSG5xx provides a cost effective pressure monitoring solution.

Although it is called Pirani Gauge Display the PGD500 also supports our PCG55x and MPG series vacuum gauges.



Advantages

- User selectable measurement unit (Pa, mbar or Torr)
- Compact bench top model design can be easily mounted in a panel or 19 in. rack
- 0 to 10 V output signal from the gauge is available for use in PLC or with a chart recorder
- One free adjustable set point
- User selectable aguge PSG, PCG and MPG

Applications

- Fore vacuum pressure measurement
- Pressure measurement on filling stations for RAC and automotive applications
- Pressure measurement in light bulb production lines
- General vacuum measurement and control in the medium and rough vacuum range

Ordering Information

Type	PGD500
Pirani Gauge Display	398-802

Accessories

Sensor cable ¹⁾	1.3 m (4.27 ft.)	398-498
Seal with centering ring and filter	DN 16 ISO-KF	211-090
Adapter for rackmount 2HE / 3HE		398-499

¹⁾ Other lengths on request

PGD500 (continued)

Specifications

Measurement channels (sensors to connect)		1 (PSG5xx, PCG5xx or MPG series)
Display		LED
Range	Pa	$5 \times 10^{-2} \dots 1 \times 10^5$
	mbar	$5 \times 10^{-4} \dots 1000$
Measurement rate	1/s	30
Measurement unit (selectable)		Pascal, mbar, Torr
Setpoint		
Setpoint relay		1
Adjustment range		$1 \times 10^{-3} \dots 500$
Hysteresis		$\geq 10\%$ of measurement value
Relay contact		Floating changeover contact
Contact rating	V (ac) / A	50 / 5
Connector		D-Sub, 9 pin, male
Analog output	V	0 ... 10.3, sensor output signal
Power		
Supply	V (ac)	100 ... 240
Frequency	Hz	50 ... 60
Consumption	VA	≤ 30
Temperature		
Operation (ambience)	°C	+5 ... +50
Storage	°C	-20 ... 60
Relative humidity		$\leq 80\%$ up to +31°C Decreasing to 50% at +40°C
Degree of protection		IP20
Weight	kg	0.85

Dimensions

mm (in.)

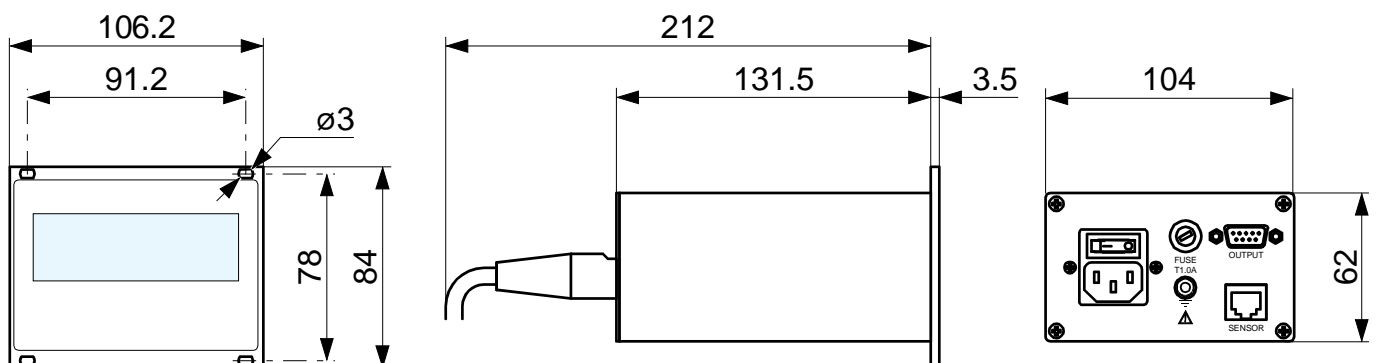

Vacuum Switch

VSA100A

The pressure switch VSA100A is used as a safety switch in vacuum systems. For example, to automatically interrupt the gas supply when venting vacuum systems with a purge gas at a pressure of 6 mbar below atmospheric pressure.

At a differential pressure of 6 mbar resp. return switching pressure of 3 mbar below atmospheric pressure, an elastic diaphragm actuates a changeover contact which in turn may be used to switch directly any ancillary equipment.

The electrical connections are protected by a plastic cover.



Advantages

- Reliable and budget-priced vacuum switch
- Long service life
- Rugged design
- Easy to integrate
- IP 44 protection
- Can be connected to a programmable control

Applications

- Control of load lock chambers
- Safety shutdown of vacuum systems

Ordering Information

Type	VSA100A
DN 16 ISO-KF, complete with 3 m (9.9 ft.) cable	399-001

VSA100A - continued

Specifications

Switching pressure	mbar	6 ±2 (below atmosphere)
Back switching	mbar	3 ±2 (below atmosphere)
Operating pressure (absolute)	bar	<2
Helium permeation	mbar l/s	<10 ⁻⁶
Leak rate	mbar l/s	<5 x 10 ⁻⁸
Temperature		
Operation	°C	0 ... +85
Storage	°C	-20 ... +85
Switching contacts (gold plated)		Change over contact
Voltage max.	V (dc) / V (ac)	24/24
Current max.	mA	30 (24 V (dc)) / 100 (24 V (ac))
Load min.	mA	1
Electrical connector		Cable, bare wire
Cable length, standard	m (ft.)	3 (9.9)
Vacuum connection		DN 16 ISO-KF
Protective type		IP 44
Mounting orientation		Vertical (standing)
Internal volume	cm ³ (in. ³)	2 (0.122)
Materials exposed to vacuum		Stainless steel 1.4305, EPDM, PTFE (Teflon)
Weight	g	315

Technical Note: Due to the diaphragm material used (EPDM), the Vacuum Switch VSA100A is not suited for applications in which the process gas contains large quantities of helium. The leak rate of the diaphragm for helium is <10⁻⁶ mbar l/s.

Dimensions

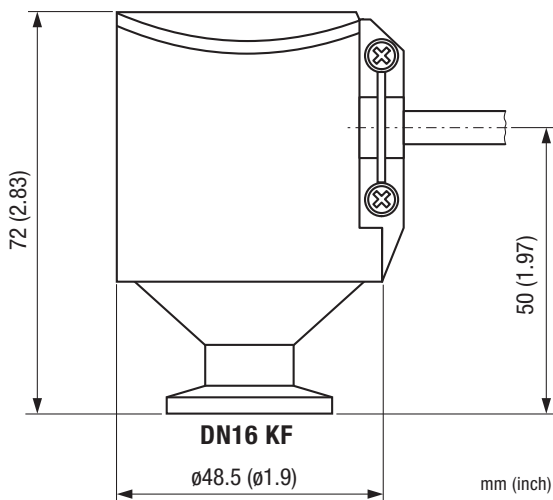

Vacuum Switch

VSA200, VSD200

INFICON Vacuum Switches are designed for accurate and reliable pressure detection. These robust electronic switches are used in all vacuum applications, including pressure interlock. The switches are available in two versions, absolute (references vacuum) or differential (references ambient).

Advantages

- Corrosion resistant all stainless steel design
- Relay output with potential free contacts
- Easy installation with setpoints factory preset or field-adjustable
- High-accuracy temperature compensated sensor
- Robust design, cleanroom compliant
- Pressure range 1×10^{-9} mbar ... 2 bar
- CE, RoHS

Applications

- Atmospheric pressure detection for all vacuum applications
- Pressure interlock (power supplies, gas supplies, pumps, valves, actuators, etc.)
- Vacuum to high vacuum



VSA200, VSD200 - continued

Ordering Information VSA200 absolute switch

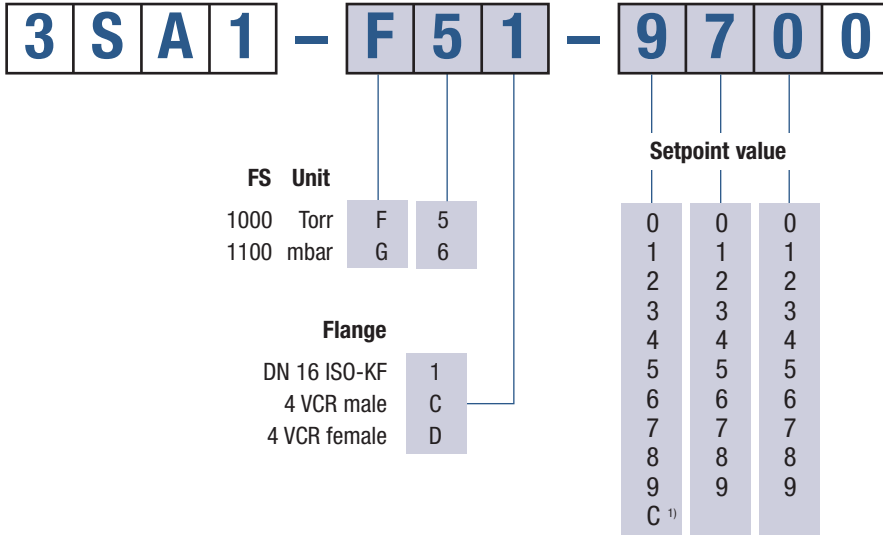

Example: Setpoint at 970 Torr absolute pressure, DN 16 ISO-KF:
 Setpoint at 1080 mbar absolute pressure, 4 VCR male:

3SA1-F51-9700
3SA1-G6C-C800

Ordering Information VSD200 differential switch

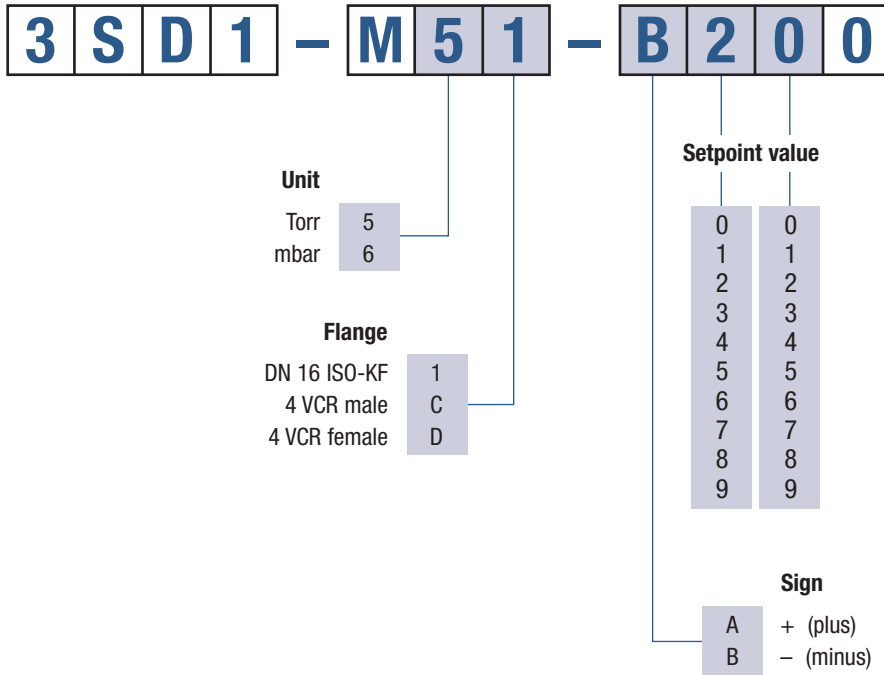

Example: 20 Torr below ambient pressure, DN 16 ISO-KF: **3SD1-M51-B200**

VSA200, VSD200 – continued

Specifications

		VSA200		VSD200	
Full Scale (F.S.)	mbar (absolute)	–	1100	–	–
	Torr (absolute)	1000	–	–	–
Differential range ¹⁾	mbar	–	–	–	–100 ... +50
	Torr	–	–	–100 ... +50	–
Setpoint range	mbar	–	30 ... 1060	–	–99 ... +46
	Torr	20 ... 970	–	–99 ... +46	–
Admissible pressure	bar (absolute)		5		2
Setpoint relay					
Relay output				n.o., n.c., potential free	
Contact rating	V / A (dc)			30 / 1	
	V / A (ac)			125 / 0.3	
Setpoint accuracy	% F.S.			0.5	
Temperature effect on zero and span	% F.S. / °C			≤±0.02	
Response time	ms			≤45	
Hysteresis	% F.S.			2	
Electrical connection				D-Sub, 9-pin	
Supply voltage	V (dc)			14 ... 30	
Power consumption	W			<0.5	
Admissible temperature					
Operation (ambient)	°C			0 ... 70	
Storage	°C			–40 ... 80	
Materials exposed to vacuum				Stainless steel	
Mounting orientation				Any	
Internal volume					
DN 16 ISO-KF	cm ³ (in. ³)			2.81 (0.17)	
4 VCR	cm ³ (in. ³)			0.93 (0.057)	
Weight	g			140	
Degree of protection				IP 40	
Sensor protection				Short circuit protection and reverse polarity protection	

¹⁾ References to ambient pressure.

VSA200, VSD200 – continued

Dimensions

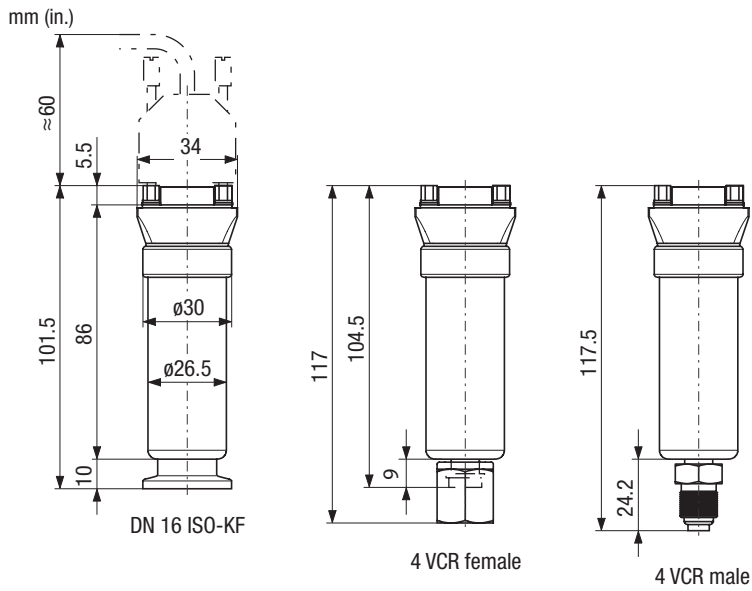

Accessories

Communication adapter (2 m) for PC USB port ¹⁾

303-336

¹⁾ Software to read or write data on Windows can be downloaded from our website.

Vacuum Switch

VSC150A

The INFICON Vacuum Switch VSC150 is an absolute pressure switch with an adjustable electrical switching contact from 0.5 to 2000 mbar. The mechanical design allows short term overload of 3000 mbar without impairing the switching accuracy of ± 0.1 mbar. INFICON offers customer specific adjustment of pressure switch.

Advantages

- High switching accuracy (± 0.1 mbar)
- Stable long term operating characteristics
- Rugged, corrosion protected design
- Increased switching capability when using switching amplifier
- Switching contacts (normally closed) in the reference chamber and thus protected against process media
- Adapter available for differential pressure measurement

Applications

- Pressure switch or differential pressure switch to control valves, pumps, power supplies
- Load lock chambers
- Process chambers



Ordering Information

Type	VSC150A
DN 16 ISO-KF	399-005

Accessories

SV Switching Amplifier	399-008
Pressure Switch Adjustment	399-006
Differential Pressure Adapter	399-007

VSC150A - continued

Specifications

VSC150A Vacuum Switch		
Switching range	mbar	0.5 ... 2000
Response sensitivity	mbar	0.1
Overload limit	mbar	3000
Switching hysteresis	mbar	0.5
Temperature		
Operation (ambient)	°C	5 ... 90
Storage	°C	-20 ... 70
Bakeout (max. 8 h)	°C	120
Coefficient of switch point	% / K of switching value	0.4
Vacuum connection		DN 16 ISO-KF
Electrical connection		Protected plug (DIN 43650)
Switch		n.c.
Switching voltage	V	24
Switching current	mA	10
Contact resistance	Ω	<1
Protection category		IP 65
Materials in contact with the medium		
Sensing volume		Stainless steel 1.4301, 1.4401, 1.4310, 1.3541, FPM75
Reference volume		Stainless steel 1.4301, 1.4401, 1.3541, glass, gold
Sensing volume ¹⁾	cm ³	≈4
Reference volume	cm ³	≈20
Weight	kg	1.3

¹⁾ Including connection port.

Specifications

SV Switching Amplifier		
Mains supply (selectable)	V	110 ... 130, 220 ... 240
Mains frequency	Hz	50 / 60
Power consumption	VA	3
Output relay		
Switching voltage	V	250
Switching current	A	5
Switching capacity	VA	500
Response time	ms	30
Release time	ms	7
Control circuit	V / mA	24 / 10
Operation temperature	°C	5 ... 50
Weight	kg	0.36

VSC150A - continued

Dimensions

VSC150A Vacuum Switch

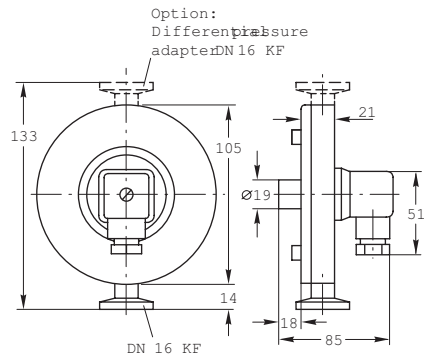

mm

SV Switching Amplifier

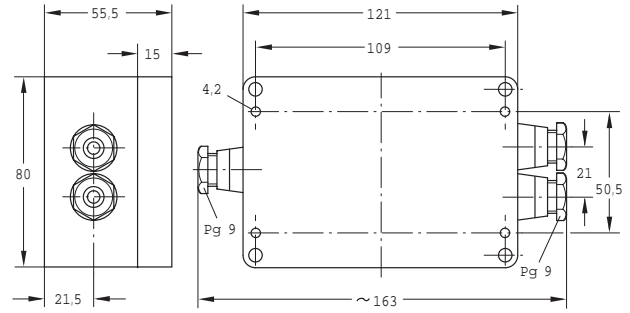

mm

Pirani Gauge Enhanced – Passive

PGE050

The INFICON Pirani Gauge Enhanced 050 (PGE050) is the passive version of our active convection enhanced Pirani gauges PGE300 and PGE500. Equipped with the same sensor technology, the PEG050 works in conjunction with our VGC031 passive gauge controller unit to produce the same higher accuracy readings in the measurement range between 100 to 1000 mbar. With its wider measuring range and higher accuracy, especially at lower pressures, the PGE050 is the first choice when replacing thermocouple gauges in your vacuum system. The rugged gauge and sensor design makes the PGE050 a high value/low cost of ownership choice and qualifies this gauge for many applications where an economical vacuum measurement from low to high vacuum range is required.



Advantages

- Convection Enhanced Pirani Technology for wide measurement range and higher accuracy near atmosphere
- Gold plated tungsten filament
- Mechanical strength, highly robust and less susceptible to mechanical shock and vibration
- Choice of flange options
- Compliance & standards: CE, RoHS
- Direkt drop in replaces Granville-Phillips® Convectron® gauge sensor (same plug/ pinouts)
- PGE050 accepts Granville-Phillips® Convectron® controllers, cables and modules
- Ideal gauge sensor for upgrading your installed thermocouple gauges

Applications

- Fore vacuum pressure measurement
- General vacuum measurement and control from low to the high vacuum range

Ordering Information

Type	MPG400 Tungsten gold-plated
DN 16 ISO-KF	352-500
DN 25 ISO-KF	352-501
DN 40 ISO-KF	352-502
DN 16 CF-R	352-503
DN 40 CF-R	352-504
4 VCR female	352-505
8 VCR female	352-506
1/8" NPT	352-507

PEG050 (continued)

Specifications

Type		PEG050
Filament		Tungsten gold-plated
Measurement range	mbar	1.3×10^{-4} ... 1333
	Torr	1×10^{-4} ... 1000
	Pa	1.3×10^{-2} ... 133000
Accuracy (N ₂) ¹⁾	1.3×10^{-4} ... 1.3×10^{-3} mbar	0.1 x 10 ⁻³ mbar resolution
	1.3×10^{-3} ... 530 mbar	% of reading
	530 ... 1333 mbar	% of reading
	1×10^{-4} ... 1×10^{-3} Torr	0.1 mTorr resolution
	1×10^{-3} ... 400 Torr	% of reading
	400 ... 1000 Torr	% of reading
Repeatability (N ₂) ¹⁾	% of reading	±2
Temperature		
Operation (ambient)	°C	0 ... +50
Bakeout ²⁾	°C	≤150
Materials exposed to vacuum	gold-plated tungsten, 304 & 316 stainless steel, glass, nickel, Teflon®	
Internal volume	cm ³ (in. ³)	26 (1.589)
Internal surface area	cm ² (in. ²)	59.7 (9.25)
Weight	g (oz)	85 (3)

¹⁾ typically

²⁾ non-operating, with electronics cable detached

Dimensions

mm (in.)

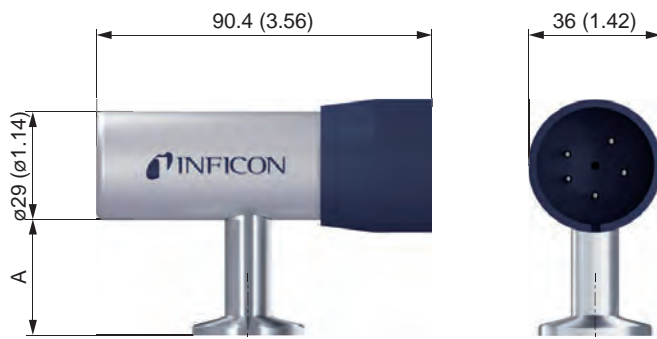

Dimension A	mm	(in)
DN 16 ISO-KF	33	(1.3)
DN 25 ISO-KF	33	(1.3)
DN 40 ISO-KF	33	(1.3)
DN 16 CF-R	27.4	(1.08)
DN 40 CF-R	37.3	(1.47)
4 VCR female	47.2	(1.86)
8 VCR female	44.5	(1.75)
1/8" NPT male	25.4	(1)

Vacuum Gauge Controller

VGC031

The INFICON Vacuum Gauge Controller 031 (VGC031) is designed for use in conjunction with the INFICON Pirani Gauge Enhanced 050 (PGE050) and acts as a convenient power supply, control and readout. VGC031 and PGE050 are a flexible combination to monitor your vacuum system in the range from 1.3×10^{-4} up to 1333 mbar (1×10^{-4} up to 1000 Torr). The VGC031 with its space saving panel mount housing supports a variety of technical features as 2 set point relays, 4 user selectable analog outputs and offers additionally RS232 / RS485 digital interfaces. The bright, sharp and clear OLED display with the integrated keypad user interface rounds out this user friendly vacuum gauge controller package. The rugged industrial design makes the VGC031 in combination with the convection enhanced PGE050 gauge sensor a very good choice for many vacuum applications where economical vacuum measurement from low to high vacuum range is required.



Advantages

- Display's and controls wide measurement range from 1.3×10^{-4} up to 1333 mbar (1×10^{-4} up to 1000 Torr).
- Bright digital OLED display with keypad for simple set up and operation
- 4 user selectable analog output signals
- 2 set point relays
- RS232 / RS485 digital interface
- Space saving design - 1/8-Din panel mount housing for rack mount installation or as standalone unit
- Powered through user supplied 12 to 28 V (dc) or by INFICON's VGC031 Power Supply
- Compliance & standards: CE, RoHS
- VGC031 controller and PGE050 convection enhanced vacuum gauge sensor and cable can direct drop in replace Granville-Phillips® 375 and 475 controllers and 275 Convectron® gauge sensors and gauge cable (Remote interface, relay and power connectors are different)

Applications

- Fore vacuum pressure measurement
- General vacuum measurement and control from low to the high vacuum range

Ordering Information

Type	VGC031
	399-570

VGC031 – continued

Accessories

Gauges	PGE050 (see PEG050)
Power supply for VGC031 ¹⁾	399-575
Cable VGC031 to PGE050 in m (ft) ²⁾	
3 (10)	399-580
8 (25)	399-581
15 (50)	399-582
Mating connector kit for PGE050	399-591

¹⁾ The IEC 60320 AC power entry receptacle allows use with any user supplied AC mains cord set available worldwide

²⁾ Other length on request

Specifications

Type	VGC031	
Measurement channels	1	
Display	OLED	
Display update rate	1/s	0.5s
Connectable gauge with display range		
PGE050 (see PGE050)	mbar	$1.3 \times 10^{-4} \dots 1333$
	Torr	$1 \times 10^{-4} \dots 1000$
	Pa	$1.3 \times 10^{-2} \dots 133000$
Connector	gauge	9-pin D-Sub female ¹⁾
	analog output, serial interface	9-pin D-Sub male
	relay outputs	6-pin pluggable terminal block ²⁾
	power	2-pin pluggable terminal block ²⁾
Measurement unit (selectable)	mbar, Torr, Pa	
Setpoint relay	2 (single-pole double-throw relays (SPDT)) 1 A at 30 V (dc) resistive, or V (ac) non-inductive	
Analog output		
Range (selectable)	V (dc)	0 ... 7 or 1 ... 8 (log-linear, 1 V/decade)
	V (dc)	0 ... 10 (linear)
	V (dc)	0.375 ... 5.659 (non-linear S-curve)
	V (dc)	0 ... 9 (non-linear S-curve)
Interface (digital)	RS232, RS485	
Supply voltage	V (dc)	+12 ... +28 ³⁾
Temperature		
Operation (ambient)	°C	0 ... 40
Storage	°C	-40 ... +70
Housing	1/8-DIN panel-mount enclosure (aluminum extrusion)	
Weight	g (oz)	250 (9)

¹⁾ mating connector provided as part of the gauge cable

²⁾ mating connector included

³⁾ 2 W protected against power reversal and transient over-voltages

VGC031 - continued

Dimensions

mm (in.)

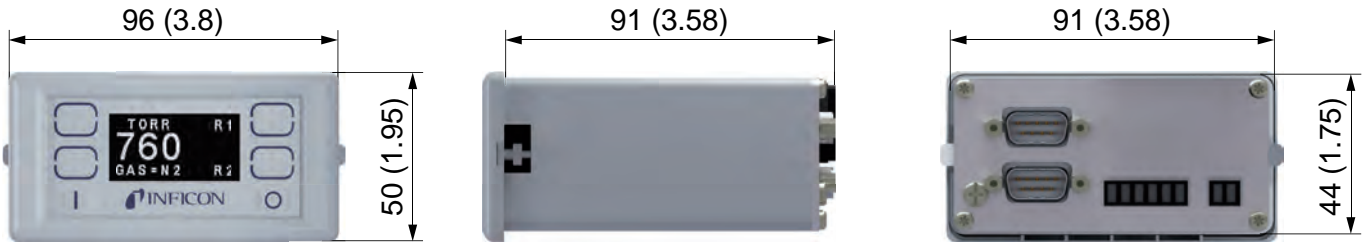

Accessories

Power supply for VGC031 ¹⁾

352-575



Input power:	V (ac)	100 ... 240
Output power:	V (dc)	+24
Cable length:	m (ft)	2 (6)

¹⁾ The IEC 60320 AC power entry receptacle allows use with any user supplied AC mains cord set available worldwide

Bayard Alpert Vacuum Gauge Heads – Passive

BAG050, BAG051, BAG052, BAG053

The INFICON Bayard-Alpert passive vacuum gauge heads BAG050, BAG051, BAG052 and BAG053 are designed for use with the INFICON Vacuum Gauge Controller VGC083A & VGC083B. Yttria coated iridium filaments are offered for general vacuum applications in air and inert gases such as N₂ and argon. Select tungsten filaments for gases that are not compatible with yttria coated iridium filaments. BAG05x gauges may also be operated with compatible vacuum gauge controllers from other manufacturers. The INFICON passive Bayard-Alpert ionization vacuum gauges (BAG05x) are offered in three different configurations: BAG050 is a EB-degas UHV nude ionization vacuum gauge capable of pressure measurement as low as 2×10^{-11} Torr
BAG051 is a resistive degas (I²R) nude ionization vacuum gauge capable of pressure measurement as low as 4×10^{-10} Torr
BAG052 and BAG053 are resistive degas (I²R) glass enclosed ionization vacuum gauges capable of pressure measurement as low as 4×10^{-10} Torr.



Advantages

- Reliable and proven gauge head design
- Drop in for most nude hot ion guage heads
- Wide range of emission currents (100 µA to 10 mA)
- Available with single / dual yttria coated iridium and dual tungsten filament cathode assemblies
- Degas: All models can be degased using EB (electron bombardment).
BAG051, BAG052 and BAG053 can also be degased using resistive degas (I²R)

Applications

- UHV and research
- Industrial coating
- General vacuum measurement and control in the low to ultra high vacuum range

BAG050, BAG051, BAG052, BAG053 (continued)

Ordering Information BAG050 HOT ION GAUGE

Type	BAG050
BA nude EB-degas, DN40CF, dual iridium filament (Ir)	399-720
BA nude EB-degas, DN40CF, dual tungsten filament (W)	399-721
Spare dual iridium filament (Ir)	399-730
Spare dual tungsten filament (W)	399-731



Ordering Information BAG051 HOT ION GAUGE

Type	BAG051
BA nude I ² R, DN40CF, single iridium filament (Ir)	399-725
BA nude I ² R, DN40CF, dual iridium filament (Ir)	399-726
BA nude I ² R, DN40CF, dual tungsten filament (W)	399-727
Spare V-iridium filament (Ir)	399-735
Spare dual iridium filament (Ir)	399-736
Spare dual tungsten filament (W)	399-737



Ordering Information BAG052 HOT ION GAUGE

Type	BAG052
BA glass I ² R, 3/4" Kovar metal inlet port , single iridium filament (Ir)	399-740
BA glass I ² R, 1" Kovar metal inlet port , single iridium filament (Ir)	399-741
BA glass I ² R, 3/4" glass inlet port , single iridium filament (Ir)	399-742
BA glass I ² R, 1" glass inlet port , single iridium filament (Ir)	399-743
BA glass I ² R, DN25KF , single iridium filament (Ir)	399-744
BA glass I ² R, DN40KF , single iridium filament (Ir)	399-745
BA glass I ² R, DN16CF , single iridium filament (Ir)	399-746
BA glass I ² R, DN40CF , single iridium filament (Ir)	399-747



Ordering Information BAG053 HOT ION GAUGE

Type	BAG053
BA glass I ² R, 3/4" Kovar metal inlet port , dual tungsten filament (W)	399-750
BA glass I ² R, 1" Kovar metal inlet port , dual tungsten filament (W)	399-751
BA glass I ² R, 3/4" glass inlet port , dual tungsten filament (W)	399-752
BA glass I ² R, 1" glass inlet port , dual tungsten filament (W)	399-753
BA glass I ² R, DN25KF , dual tungsten filament (W)	399-754
BA glass I ² R, DN40KF , dual tungsten filament (W)	399-755
BA glass I ² R, DN16CF , dual tungsten filament (W)	399-756
BA glass I ² R, DN40CF , dual tungsten filament (W)	399-757



BAG050, BAG051, BAG052, BAG053 (continued)

Specifications (Torr based standard products)

Typ		BAG050	BAG051	BAG052	BAG053
Measurement range	mbar	$2.7 \times 10^{-11} \dots 1.3 \times 10^{-3}$		$5.3 \times 10^{-10} \dots 1.3 \times 10^{-3}$	
	Torr	$2 \times 10^{-11} \dots 1 \times 10^{-3}$		$4 \times 10^{-10} \dots 1 \times 10^{-3}$	
	Pa	$2.7 \times 10^{-9} \dots 1.3 \times 10^{-1}$		$5.3 \times 10^{-8} \dots 1.3 \times 10^{-1}$	
Accuracy (N ₂)	%			20	
X-ray limit	Torr	2×10^{-11}		4×10^{-10}	
Sensitivity (N ₂)	Torr	25^{-1}		10^{-1}	
Degas					
EB (electr. bombardment)	W	≤40	70 nominal, ≤100		≤100
I ² R (resistance heated)		-		6.3 ... 7.5 V (ac) at 10 A	
Filament					
Current	A	2.5 ... 3.5		4 ... 6	
Voltage	V (dc)	3 ... 5		3 ... 5	
Potential	V (dc)	+30		+30	
Grid potential	V (dc)			+180	
Collector potential	V			0	
Bakeout temperature	°C			450	
Collector		tungsten (W), ø0.005"		tungsten (W), ø0.010"	
Filament		dual iridium (Ir), or dual tungsten (W)	single hairpin iridium (Ir) or dual hairpin iridium (Ir), or dual tungsten (W)	single hairpin iridium (Ir)	dual hairpin tungsten (W)
Grid		photo etched closed grid		non-sag double helical 0.025" tungsten (W) grid	
Insulator			ceramic		glass to metal
Glass envelope			-		2 1/4" dia x 5" long
Mounting orientation					any
Length					
Overall	in.		4 1/8		6
Insertion	in.		3		-
Flange			2 3/4" CF / NW35CF Conflat		3/4" Kovar metal port 1" Kovar metal port 3/4" glass port 1" glass port NW25KF NW40KF 1 1/3" / NW16CF Mini-Conflat 2 3/4" CF / NW35CF Conflat
Flange material			stainless steel 304		glass Nonex 7720

Vacuum Gauge Controller

VGC083A, VGC083B

The INFICON Vacuum Gauge Controller VGC083 is designed for use with passive gauge heads BAG05x and PGE050 in a fixed combination of two PGE050 gauges and one BAG05x gauge. The VGC083 controls and monitors vacuum pressure from ATM down to 2.7×10^{-11} mbar using the BAG and PGE gauges. Six (6) single-pole relays assignable to any of the gauge heads along with RS232 and RS485 interfaces aid in system integration. The rugged industrial design of the VGC083 in combination with the passive gauge heads provide a reliable and economical system for vacuum applications requiring a wide vacuum measurement range.



Advantages

- Simple operation with special OLED display for parameter, sensor or general settings with softkeys
- Very bright and clear LED display for long distance vacuum pressure read-out
- Three analog outputs, user assignable to any of the gauges
- Degas electron bombardment or I²R resistive heating for gauge conditioning depending on gauge head type
- Remote digital I/O sensor & emission on/off
- Sensor 1 can be automatically turned on/off from sensor 2 or 3
- Three definable setpoints per channel with adjustable hysteresis
- RS232 / RS485 serial communication
- 6 assignable single pole double through setpoint relays
- Ion gauge overpressure protection
- Alternative active gauge use
- User selectable filament
- Direct drop in replaces Granville-Phillips® 307 Bayard-Alpert Gauge Controller

Ordering Information

Type	VGC083A	VGC083B
Vacuum Gauge Controller	399-700	399-701
Power supply VGC083A/B	399-710	399-710
Rack mount adapter one VGC083A/B	399-714	399-714
Rack mount adapter two VGC083A/B	399-715	399-715

VGC083A, VGC083B (continued)

Specifications

Type		VGC083A	VGC083B
Measurement channels		3	
Display			
Pressure indication		LED - 3 independent pressure display channels	
Programming & set-up screen		OLED	
Connectable gauges with display range			
PGE050	mbar/Torr	1.3 x 10 ⁻⁴ ... 1333 / 1 x 10 ⁻⁴ ... 1000	1.3 x 10 ⁻⁴ ... 1333 / 1 x 10 ⁻⁴ ... 1000
BAG050	mbar/Torr	2 x 10 ⁻¹¹ ... 1.3 x 10 ⁻³ / 2 x 10 ⁻¹¹ ... 1 x 10 ⁻³	-
BAG051	mbar/Torr	-	4 x 10 ⁻¹⁰ ... 1333 / 4 x 10 ⁻¹⁰ ... 1000
BAG052, BAG053	mbar/Torr	-	4 x 10 ⁻¹⁰ ... 1333 / 4 x 10 ⁻¹⁰ ... 1000
Sensor 1 over pressure protection		turns hot ion gauge off at the following factory default settings	
		1 x 10 ⁻³ Torr at 100 µA emission current	
		5 x 10 ⁻⁴ Torr at 4 µA emission current	
		1 x 10 ⁻⁴ Torr at 10 µA emission current	
Connectors		terminal block, mating connectors included	
	BAG supply	CPC ¹⁾	
	BAG col	BNC ¹⁾	
	PGE050	D-sub, 9 p-pin female	
	Remote digital I/O	D-sub, 9 p-pin male	
	RS232	D-sub, 9 p-pin female	
	RS485	D-sub, 9 p-pin male	
	Analog out	2 pole pluggable	
	Analog in	3 pole pluggable	
	Relay	each 3 pole pluggable	
	DC power	3 pole pluggable	
Measurement unit (selectable)		mbar (default), Torr, Pa	
Setpoint relays		6 single-pole double-throw relays (SPDT), user assignable to any of the gauges	
Contact rating		5 A at 30 V (dc), 5 A at 250 V (ac), resistive load	
Analog output			
BAG analog output	V (dc)	0 ... 10 (log-linear, 1 V/decade)	
	V (dc)	1.7 ... 9.3 (nominal 1.8 ... 8.7 (log-linear, 0.8 V/decade)	
Combination BAG & PEG analog	V (dc)	0 ... 10 (linear, usable over 3 decades)	
	V (dc)	0.5 ... 7 (log-linear, 0.5 V/decade)	
PEG analog output	V (dc)	1 ... 8 (log-linear, 1 V/decade)	
	V (dc)	0 ... 7 (log-linear, 1 V/decade)	
	V (dc)	0 ... 10 (linear, usable over 3 decades)	
	V (dc)	0.375 ... 5.659 (non-linear, S-curve usable over 3 decades)	
Interface (digital)		RS232, RS485 ²⁾	
Supply voltage (external)		V (dc) +20 ... +28 ³⁾	
Temperature			
Operation (ambiance)	°C	+0 ... +40	
Storage	°C	-40 ... +70	
Humidity		0 ... 95% relative humidity, non-condensing	
Housing		aluminium housing	
Weight		kg / lb. 0.7 / 1.7	

¹⁾ Gauge cable assemblies provided by INFICON

²⁾ Command protocol compatibility with GP307

³⁾ 200 W protected against power reversal and transient over-voltages

VGC083A, VGC083B (continued)

Connectable Gauges

	VGC083A	VGC083B
BAG050 Hot Ion Gauge		
BA nude EB-degas, DN40CF, dual iridium filament (Ir)	399-720	–
BA nude EB-degas, DN40CF, dual tungsten filament (W)	399-720	–
BAG051 Hot Ion Gauge		
BA nude I ² R, DN40CF, single iridium filament (Ir)	–	399-725
BA nude I ² R, DN40CF, dual iridium filament (Ir)	–	399-726
BA nude I ² R, DN40CF, dual tungsten filament (W)	–	399-727
BAG052 Hot Ion Gauge		
BA glass I ² R, ¾" Kovar metal inlet port , single iridium filament (Ir)	–	399-740
BA glass I ² R, 1" Kovar metal inlet port , single iridium filament (Ir)	–	399-741
BA glass I ² R, ¾" glass inlet port , single iridium filament (Ir)	–	399-742
BA glass I ² R, 1" glass inlet port , single iridium filament (Ir)	–	399-743
BA glass I ² R, DN25KF , single iridium filament (Ir)	–	399-744
BA glass I ² R, DN40KF , single iridium filament (Ir)	–	399-745
BA glass I ² R, DN16CF , single iridium filament (Ir)	–	399-746
BA glass I ² R, DN40CF , single iridium filament (Ir)	–	399-747
BAG053 Hot Ion Gauge		
BA glass I ² R, ¾" Kovar metal inlet port , dual tungsten filament (W)	–	399-750
BA glass I ² R, 1" Kovar metal inlet port , dual tungsten filament (W)	–	399-751
BA glass I ² R, ¾" glass inlet port , dual tungsten filament (W)	–	399-752
BA glass I ² R, 1" glass inlet port , dual tungsten filament (W)	–	399-753
BA glass I ² R, DN25KF , dual tungsten filament (W)	–	399-754
BA glass I ² R, DN40KF , dual tungsten filament (W)	–	399-755
BA glass I ² R, DN16CF , dual tungsten filament (W)	–	399-756
BA glass I ² R, DN40CF , dual tungsten filament (W)	–	399-757
PGE050 Pirani Gauge Enhanced		
Pirani Gauge, DN 16 ISO-KF , tungsten filament (W)	352-500	352-500
Pirani Gauge, DN 25 ISO-KF , tungsten filament (W)	352-501	352-501
Pirani Gauge, DN 40 ISO-KF , tungsten filament (W)	352-502	352-502
Pirani Gauge, DN 16 CF-R , tungsten filament (W)	352-503	352-503
Pirani Gauge, DN 40 CF-R , tungsten filament (W)	352-504	352-504
Pirani Gauge, 4 VCR female , tungsten filament (W)	352-505	352-505
Pirani Gauge, 8 VCR female , tungsten filament (W)	352-506	352-506
Pirani Gauge, 1/8" NPT , tungsten filament (W)	352-507	352-507

VGC083A, VGC083B (continued)

Accessories

Cable to VGC083A/B for	BAG050/051 200 °C	BAG050/051 50 °C	BAG052/053 50 °C	PGE050 50 °C
3 m (9.0 ft)	399-770	399-780	399-790	399-580
8 m (25.0 ft)	399-771	399-781	399-791	399-581
15 m (50.0 ft)	399-772	399-782	399-792	399-582

Other lengths on request

Dimensions

VGC083A, VGC083B mm (in.)

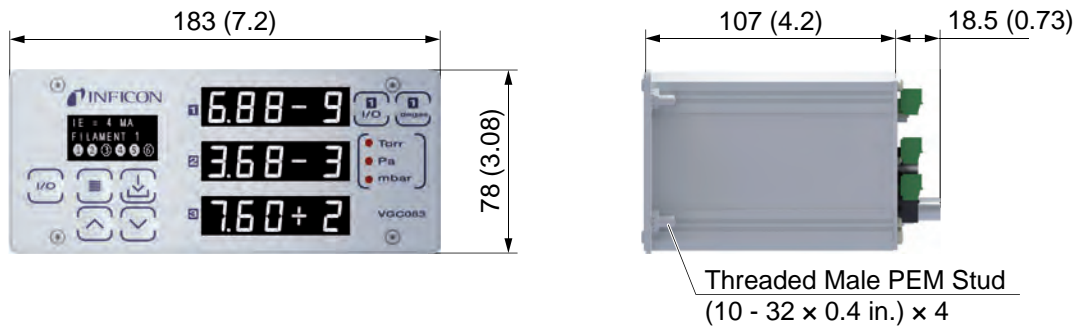

Optional rack mount adapter for one VGC083A, VGC083B

Optional rack mount adapter panel (aluminium - power paint finish) for installation of one VGC083A/B as a left-mount or a right-mount in a 2U, 19 inch wide rack.



Optional rack mount adapter for two VGC083A, VGC083B

Optional rack mount adapter panel (aluminium - power paint finish) for installation of two VGC083A/B side-by-side in a 2U, 19 inch wide rack.



Calibration Service

Vacuum Gauges

INFICON offers calibration services for vacuum gauges. DAkks (Deutsche Akkreditierungsstelle; according to DIN EN ISO/IEC 17025:2005) calibration certificate or factory calibration certificate can be issued.

All issued inspection documents are in compliance with the European Standard EN 10204

Advantages

- Known deviation to calibration standards
- Controlled quality over time

Applications

- Reference to standard is required
- Reference for customer in house calibration service of vacuum gauges

DAkks Calibration

The German Calibration Service (DAkks) ensures traceability of industrial measurements and testing to national calibration standards. It is run jointly by the Federal Institution for Physics and Technology (PTB), the Industry, the federal Minister for Economics and the Western European Metrology Club (WEMC).

The transfer standards employed in the DK calibration facility are checked regularly (recalibrated) by the PTB.

Factory Calibration

Factory calibrations traced back to DAkks transfer standards.

CDG gauges are calibrated on a special tool with traceability to national standards at PTB.

Thus traceability to national standards is ensured in both cases.

Other Calibrations

NIST Calibration available upon request. Call for availability and pricing.

Ordering Information

Calibration Service for	Calibration Range [mbar], [Torr]	DAkks Calibration ¹⁾	Factory Calibration ¹⁾
Pirani, Pirani Combination Gauges	1 x 10 ⁻³ ... 30	398-900	398-910
Capacitance Diaphragm Gauges	1 x 10 ⁻³ ... 1000	–	398-913
Capacitance Diaphragm Gauges (gauges with measurement cable to controller)	1 x 10 ⁻³ ... 1000	–	398-914
Bayard Alpert, Cold Cathode, High Pressure and Combination Gauges	1 x 10 ⁻⁶ ... 30	398-902	–
Bayard Alpert, Cold Cathode, High Pressure and Combination Gauges	5 x 10 ⁻⁷ ... 1000	–	398-912

¹⁾ Pressure media: Nitrogen

Inspection Documents Service

Vacuum Control

INFICON offers a inspection documents service for Vacuum Control products.

All issued inspection documents are in compliance with the European Standard EN 10204

Advantages

- Choice of three different inspection documents for customers individual needs
- Inspection documents according to European Standard EN 10204

Ordering Information

Designation of Inspection Document	Type	Ordering Number
Declaration of compliance with the order (Werksbescheinigung 2.1)	EN 10204-2.1	211-801
Test report (Werkszeugnis 2.2)	EN 10204-2.2	211-802
Inspection certificate (Abnahmeprüfzeugnis 3.1)	EN 10204-3.1	211-800

Please check with the given information in the following chart the right inspection document for your specific needs and order your choice of inspection document together with the corresponding Vacuum Control product you need it for.

The inspection document will be issued and delivered together with your goods and / or can be sent as pdf file for your attention. For pricing or specific questions concerning inspection documents please call our customer service center.

Inspection Documents Service

INSPECTION DOCUMENTS	EN 10204-2.1	EN 10204-2.2	EN 10204-3.1
Inspection document	Declaration of compliance with the order	Test report	Inspection certificate
Kind of inspection	Non-specific inspection. The products inspected are not necessarily the products actually supplied.	Non-specific inspection. The products inspected are not necessarily the products actually supplied.	Specific inspection. The products inspected are the products, or part of the products, actually supplied.
Contents of inspection document	Manufacturer's declaration that the products supplied are in compliance with the requirements of the order, without inclusion of test results.	Manufacturer's declaration that the products supplied are in compliance with the requirements of the order, with test results based on non-specific inspection.	Manufacturer's declaration that the products supplied are in compliance with the requirements of the order, with test results based on specific inspection.
Conditions of delivery	In accordance with conditions of order.	In accordance with conditions of order.	According to regulations of authorities and the corresponding technical rules.
Inspection document confirmed by	The manufacturer	The manufacturer	The manufacturer's authorized inspection representative, independent of the manufacturing department
Example for ordering at INFICON	Add ordering number 211-801 to your order in a separate order position directly after the order position of the corresponding parts you like to have the declaration of compliance for.	Add ordering number 211-802 to your order in a separate order position directly after the order position of the corresponding parts you like to have the test report for.	Add ordering number 211-800 to your order in a separate order position directly after the order position of the corresponding parts you like to have the certificate for.
Notes by INFICON	If this declaration is needed for all of your purchase order items you simply can add the ordering number 211-801 at the end of your order in the last position and state that it should be valid for the whole order	The test report just can be issued to a specific part number you have ordered. It can't be valid for multiple part numbers. It should be ordered along with the corresponding product it belongs to (add ordering number 211-802 directly after the product it belongs to).	This certificate just can be issued to a specific part number you have ordered. It can't be valid for multiple part numbers. It strictly has to be ordered along with the corresponding product it belongs to (add ordering number 211-800 directly after the product it belongs to). The original certificate always comes along with the corresponding product it belongs to. On customer request we can send it in addition to our shipment as pdf file by email or by post (copies).
Inspection document available for	All INFICON Vacuum Control products	All INFICON Vacuum Control products	Majority of our vacuum fittings (usually this certificate is asked for fittings made of stainless steel and aluminium and their specific chemical composition). Other Vacuum Control products on request and according feasibility. Please define in your request values you like to have tested and confirmed. Standard prices apply for this type of certificate, however we reserve the right to apply further charges for any additional work that maybe required.



Vacuum Feedthroughs

Vacuum Feedthroughs

Rotary Feedthroughs ISO-KF / ISO-K

FRH DN 16 - DN 63	B1
-------------------------	----

Rotary Feedthroughs CF

FRU DN 16 - DN 40	B3
-------------------------	----

Rotary/Linear Motion Feedthroughs ISO-KF

FCH DN 16 - DN 40	B5
-------------------------	----

Linear Motion Feedthroughs CF

FPU DN 16 - DN 40	B7
-------------------------	----

Electrical Feedthroughs

DN 16 ISO-KF.	B9
DN 40 ISO-KF.	B11
DN 16 CF-F	B13
DN 40 CF-F	B15
DN 40 ISO-KF.	B17

Coaxial Feedthroughs ISO-KF / CF-F

BNC / MHV DN 16 - 40	B19
----------------------------	-----

Vacuum Feedthroughs

Metal-Ceramic Connections.	B21
---------------------------------	-----

Liquid Feedthroughs ISO-KF / CF-F

DN 40	B23
-------------	-----

Viewports

DN 16 - DN 50 ISO-KF.	B25
DN 63 - DN 160 ISO-K.	B27
DN 16 - DN 160 CF	B29
DN 63 - DN 160 ISO-F.	B31

Vacuum Feedthroughs

Vacuum Ball Bearings	B33
Lubricants and Sealing Materials.	B35

Inspection Documents Service

Vacuum Control	A149
----------------------	------

Rotary Feedthroughs ISO-KF / ISO-K

FRH DN 16 – DN 63

Properties

- For transmitting high torque
- With FPM shaft seal and ball bearings



Selection Data

Vacuum connection	DN 16 ISO-KF	DN 25 ISO-KF	DN 40 ISO-KF	DN 63 ISO-K
Feedthrough / seal	FPM	FPM	FPM	FPM
Shaft measure	mm	Ø5	Ø8	Ø12

Ordering Information

Type	FRH016-H	FRH025-H	FRH040-H	FRH063-H
Part No.	214-300	214-302	214-304	214-306 ²⁾

Specifications

Transferable torque	Nm	1.5	6	25	100
Rotational speed ¹⁾	rpm	1500	1000	750	500
Idling torque under vacuum	Ncm	≤3	≤4	≤5	≤10
Starting torque under vacuum	Ncm	≤6	≤8	≤10	≤20
Shaft load vacuum sided					
Radial force	N	60	150	250	500
Axial force	N	30	50	60	100
Service life	Revolutions	20 000 000	20 000 000	20 000 000	10 000 000
Tightness, static	mbar l/s	1 x 10 ⁻⁹	1 x 10 ⁻⁹	1 x 10 ⁻⁹	1 x 10 ⁻⁹
Pressure (absolute)	1 x 10 ⁻⁹ mbar ... 1 bar				
Operating temperature	°C	50			
Bakeout temperature	°C	110			
Materials exposed to process media	Stainless steel 420/1.4021 Aluminum 6082 Elastomer FPM				
Weight	kg	0.1	0.2	0.6	2

¹⁾ When a reduced service life is acceptable, the rotation can be increased by up to a factor of two

²⁾ Centering ring / CR / aluminum Part No. 212-251 / FPM / stainless steel Part No. 212-281 not included in delivery

FRH DN 16 – DN 63 (continued)

Dimensions

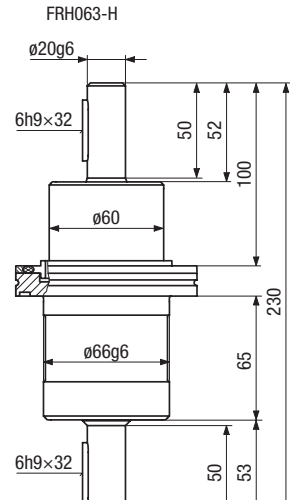
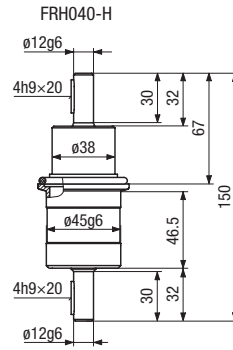
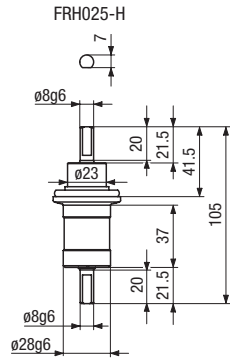
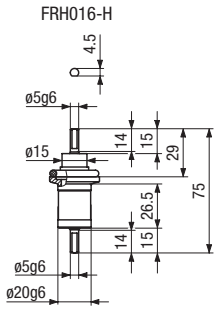

Rotary Feedthroughs CF

FRU DN 16 – DN 40

Properties

- Bellow sealed
- All-metal version
- For very demanding vacuum requirements



Selection Data

	DN 16 CF-F	DN 40 CF-F	DN 40 CF-F
Vacuum connection	DN 16 CF-F	DN 40 CF-F	DN 40 CF-F
Feedthrough / seal	bellow	bellow	bellow
Shaft connection	4 mm	8	12

Ordering Information

Type	FRU016-H	FRU040-N	FRU040-L
Part No.	214-310	214-312	214-314

Specifications

Transferable torque				
Dynamic	Nm	0.4	4	10
Dynamic, at 300°C	Nm	0.2	2	2
Static	Nm	0.2	3	5
Rotational speed	rpm	200	1000	500
At max. torque	rpm		500	300
Shaft load vacuum sided				
Radial force	N	10	60	100
Axial force	N	5	20	30
Service life	Revolutions	1 000 000	2 000 000	1 000 000
Scale division	Degree	10	–	–
Tightness	mbar l/s		5 x 10 ⁻¹¹	
Pressure (absolute)			1 x 10 ⁻¹⁰ mbar ... 2 bar	
Operating temperature	°C		300	
Bakeout temperature	°C		300	
Materials exposed to process media		304L/1.4306 304/1.4301 –/2.4360	304L/1.4306 304/1.4301	304L/1.4306 304/1.4301 303/1.4305
Weight	kg	0.3	1.5	3.0

FRU DN 16 – DN 40 (continued)

Dimensions

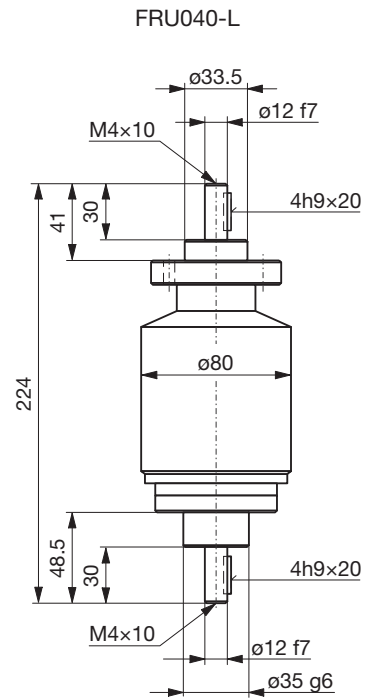
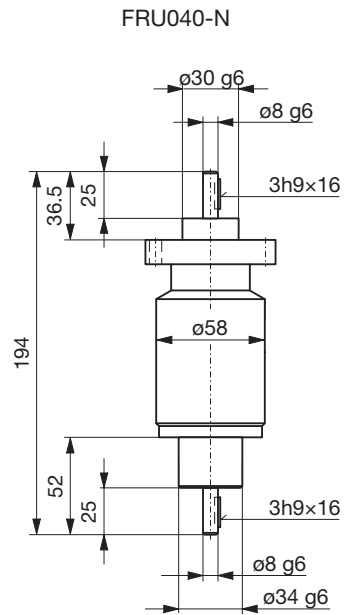
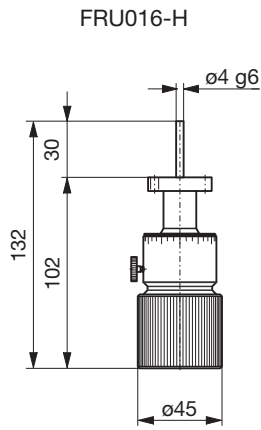

Rotary/Linear Motion Feedthroughs ISO-KF

FCH DN 16 – DN 40

Properties

- Two FPM shaft seals
- Direct push/pull and rotary actuation
- With locking ring and optional anti-rotation device



Selection Data

		DN 16 ISO-KF	DN 25 ISO-KF	DN 40 ISO-KF
Vacuum connection		DN 16 ISO-KF	DN 25 ISO-KF	DN 40 ISO-KF
Feedthrough/seal		FPM	FPM	FPM
Shaft connection		M 3 / Ø 5mm	M 4 / Ø 8mm	M 6 / Ø 12mm
Travel	mm	50	100	150

Ordering Information

Type		FCH016-H	FCH025-H	FCH040-H
Rotary/linear feedthrough	Part No.	214-320	214-322	214-324
Anti-rotation device	Part No.	214-072	214-073	214-074

Specifications

		FCH016-H	FCH025-H	FCH040-H
Shaft load				
Radial force at max.travel	N	10	15	30
Torsion torque	Nm	2	8	20
Tightness, static	mbar l/s	1 x 10 ⁻⁹		
Pressure (absolute)		1 x 10 ⁻⁸ mbar ... 1bar		
Operating temperature	°C	50		
Bakeout temperature	°C	110		
Materials exposed to process media		Stainless steel 304/1.4301 Aluminum 6082		
Weight	kg	0.1	0.2	0.3

FCH DN 16 – DN 40 (continued)

Dimensions

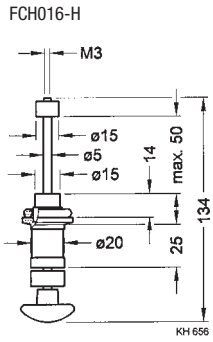

Feedthrough

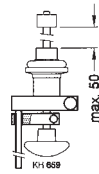

Anti-rotation device

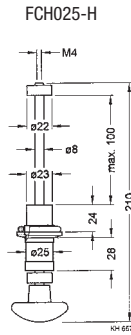

Feedthrough

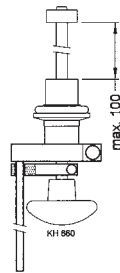

Anti-rotation device

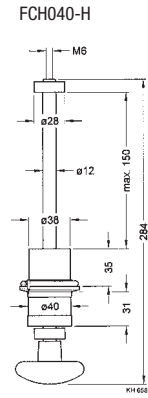

Feedthrough

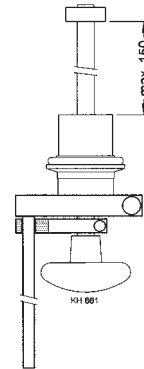

Anti-rotation device

Linear Motion Feedthroughs CF

FPU DN 16 – DN 40

Properties

- With bellows for more demanding vacuum requirements
- Direct push and pull actuation
- High accuracy adjustment using micrometer screw



Selection Data

	DN 16 CF-R	DN 40 CF-R	DN 16 CF-R	DN 40 CF-R
Vacuum connection	DN 16 CF-R	DN 40 CF-R	DN 16 CF-R	DN 40 CF-R
Feedthrough/seal	Bellow	Bellow	Bellow	Bellow
Shaft connection	M4x16 mm	M6x10 mm, Ø10 mm	M4x16 mm	M6x10mm, Ø10 mm
Actuator	Manual	Manual	Micrometer screw	Micrometer screw
Travel	25 mm	50	20	50

Ordering Information

Type	FPU016-H	FPU040-H	FPU016-Z	FPU040-Z
Part No.	214-330	214-332	214-334	214-336

Specifications

Travel per revolution	mm			0.5	1
Scale division	mm	5	10	0.01	0.005
Shaft load					
Radial force at max.	N	20	100	20	100
Axial force vacuum	N	85	140	185	440
Axial force against atm	N	100	200	200	500
Torsion torque	Nm	0.2	0.5	0.2	0.5
Tightness	mbar l/s	5×10^{-11}			
Pressure (absolute)		1×10^{-10} mbar ... 2 bar			
Bakeout temperature					
Feedthrough	°C	300	300	300	300
Micrometer screw	°C			100	100
Materials exposed to process media		stainless steel 304L/1.4306 stainless steel 316Ti/1.4571			
Weight	kg	0.15	0.75	0.25	1

FPU DN 16 – DN 40 (continued)

Dimensions

FPU016-H

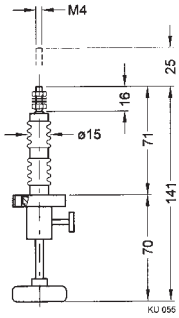

FPU040-H

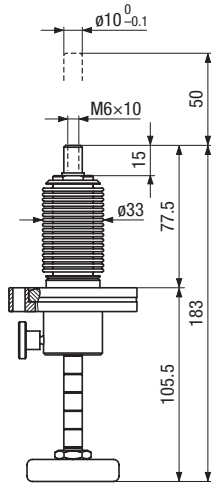

FPU016-Z

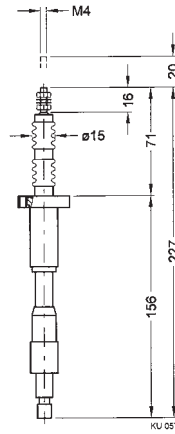

FPU040-Z

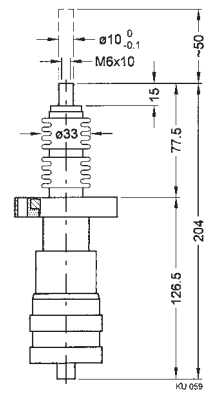

Electrical Feedthroughs

DN 16 ISO-KF



Selection Data

Vacuum connection		DN 16 ISO-KF	DN 16 ISO-KF	DN 16 ISO-KF
Number of feedthroughs		4	9	9
Voltage per pole	V	50	50	50
Current per pole	A	1	2	2

Ordering Information

Feedthrough	214-111	214-112	214-113
Connector: vacuum side	-	-	214-191
Connector: atmospheric side	214-171	214-172	214-172

Specifications

Connection				
Vacuum side		Solder connection	Solder connection	Connector
Atmospheric side		Connector	Connector	Connector
Diameter of connecting wire	mm	0.6	1.2	1.2
Tightness	mbar l/s		1×10^{-9}	
Pressure (absolute)			1×10^{-8} mbar ... 2.5 bar	
Bakeout temperature (feedthrough and connector)	°C		130	
Housing			Stainless steel 303/1.4305	
Insulator			PEEK / Araldite	
Seal			FPM	
Contacts (feedthrough and connector)			Gold-plated brass / bonze / inox	

DN 16 ISO-KF (continued)

Dimensions

214-111

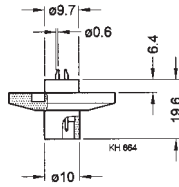

Feedthrough

214-112

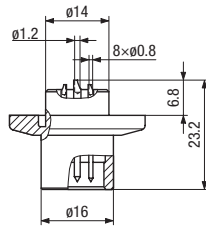

Feedthrough

214-113

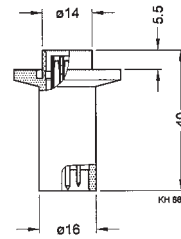

Feedthrough

214-191

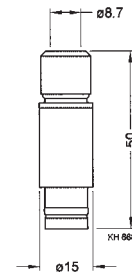

Connector:
vacuum side

214-171

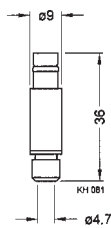

214-172

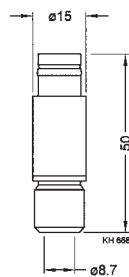

214-172

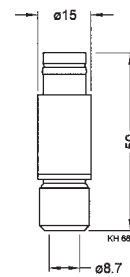

Connector:
air side

Electrical Feedthroughs

DN 40 ISO-KF



Selection Data

Vacuum connection		DN 40 ISO - KF	DN 40 ISO - KF	DN 40 ISO - KF	DN 40 ISO - KF
Number of feedthroughs		7	7	4	1
Voltage per pole	V	380	380	800	6000
Current per pole	A	16	16	16	25

Ordering Information

Feedthrough	214-121	214-122	214-123	214-131
Connector: vacuum side	–	214-193	214-194	–
Connector: atmospheric	214-174	214-174	214-175	214-180

Specifications

Connection				
Vacuum side		solder connection	connector	connector
Atmospheric side		connector	connector	connector
Diameter of connecting wire	mm	1.8	1.8	2.5
Test voltage	kV/HZ	–	–	–
Pressure (absolute)		1 x 10 ⁻⁸ mbar ... 2.5bar		
Bakeout temperature (feedthrough and connector)	°C	130		
Housing		stainless steel 303/1.4305		
Insulator		PTFE/Araldite		
Seal		FPM		
Contact (feedthrough and connector)		Gold-plated bronze	Gold-plated bronze	Gold-plated bronze
				Nickel-plated brass

DN 40 ISO KF (continued)

Dimensions

	<p>214-193</p> <p>Connector: vacuum side</p>	<p>214-194</p> <p>Connector: vacuum side</p>	
<p>214-121</p> <p>Feedthrough</p>	<p>214-122</p> <p>Feedthrough</p>	<p>214-123</p> <p>Feedthrough</p>	<p>214-131</p> <p>Feedthrough</p>
<p>214-174</p> <p>Connector: air side</p>	<p>214-174</p> <p>Connector: air side</p>	<p>214-175</p> <p>Connector: air side</p>	<p>214-180</p> <p>Connector: air side</p>

Electrical Feedthroughs

DN 16 CF-F



Selection Data

Vacuum connection		DN 16 CF-F
Number of feedthroughs		1
Voltage per pole	kV	0.3
Current per pole	A	120

Ordering Information

Feedthrough	214-126
Connection piece: vacuum side	214-195
Connector: atmospheric side	214-176

Specifications

Bakeout temperature	°C	400
Tightness	mbar l/s	5×10^{-11}
Pressure (absolute)		1×10^{-10} mbar ... 2 bar
Flange		Stainless steel 304L/1.4306
Conductor		OF-copper 2.0040
Insulator		Aluminum oxide ceramic Al ₂ O ₃
Weight		0.15
Connection piece: vacuum side		2
Current max.	A	100
Bakeout temperature	°C	400
Material		Stainless steel 304/1.4301
Connector: atmospheric side	Pieces	2
Current max.	A	100
Insulated, for use up to	V (ac) / V (dc)	Not insulated
Bakeout temperature	°C	150
Contact		Silver-plated brass

DN 16 CF-F (continued)

Dimensions

214-195

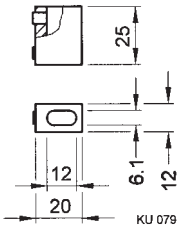

214-126

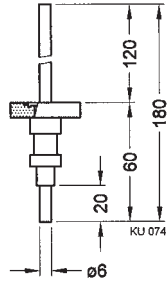

214-176

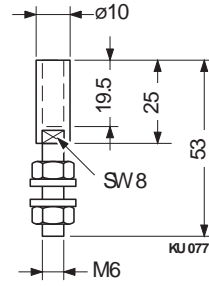

Electrical Feedthroughs

DN 40 CF-F



Selection Data

Vacuum connection		DN 40 CF-F	DN 40 CF-F	DN 40 CF-F	DN 40 CF-F	DN 40 CF-F
Number of feedthroughs		1	1	2	4	9
Voltage per pole	kV	0.3	1	4	1	1
Current per pole	A	70	200/1000 ¹⁾	150	8	8

1) With water-cooling

Ordering Information

Feedthrough	214-136	214-127	214-128	214-116	214-117
Connection piece: vacuum side	214-195	214-196	214-195	214-192	214-198
Connector: atmospheric side	214-176	214-177	214-176	214-173	214-181
Connector: atm. side, H ₂ O cooled	–	214-178	–	–	–

Specifications

Bakeout temperature	°C	400				
Tightness	mbar l/s	5 x 10 ⁻¹¹				
Pressure (absolute)		1 x 10 ⁻¹⁰ mbar ... 2 bar				
Flange		304L	304L	304L	304L	304L
Conductor		OFC 2.0040	OFC 2.0040	OFC 2.0040	304/1.4301	304/1.4301
Insulator		Al ₂ O ₃	Al ₂ O ₃	Al ₂ O ₃	Al ₂ O ₃	Al ₂ O ₃
Weight		0.15	0.5	0.45	0.3	0.5
Connection piece: vacuum side		2	1	2	5	10
Current	A	20	1000 ¹⁾	100	12	12
Bakeout temperature	°C	400	400	400	400	400
Material		304/1.4301	2.0060	304/1.4301	304/1.4301	304/1.4301
Connector: atmospheric side	Pieces	2	1	2	5	10
Current max.	A	100	250	100	25	25
Insulated, for use up to	V (ac) / V (dc)	Not insulated	30/60	30/60	30/60	30/60
Bakeout temperature	°C	150	150	50	50	50
Contact		Silver-plated brass	Silver-plated brass	Silver-plated brass	Gold-plated brass	Gold-plated brass

DN 40 CF (continued)

Dimensions

214-195

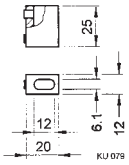

Connector vacuum side

214-196

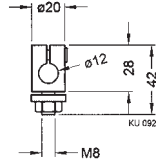

Connector vacuum side

214-195

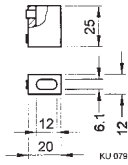

Connector vacuum side

214-192

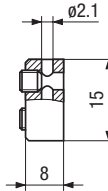

Connector vacuum side

214-198

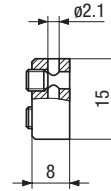

Connector vacuum side

214-136

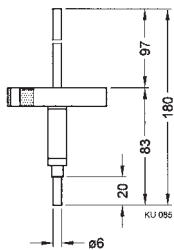

Feedthrough

214-127

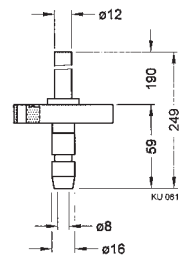

Feedthrough

214-128

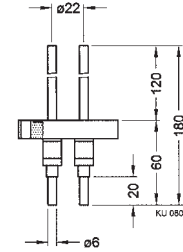

Feedthrough

214-116

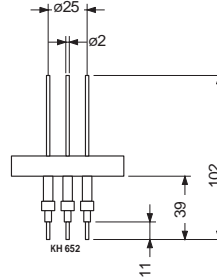

Feedthrough

214-117

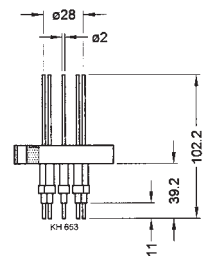

Feedthrough

214-176

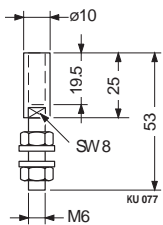

Connector air side

214-177

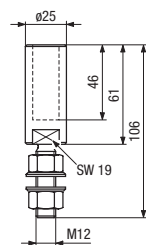

Connector air side

214-176

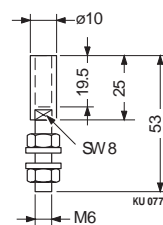

Connector air side

214-173

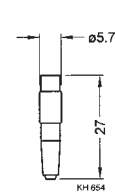

Connector air side
With soldered joint

214-181

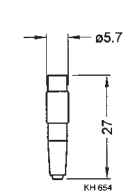

Connector air side
With soldered joint

214-178

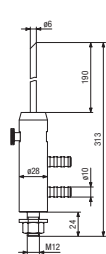

With water-proof ¹⁾		
Current max.	A	1000
Not insulated, for use up to		24
Bakeout temperature	°C	120
Contact		Silver-plated brass

High Current Feedthrough

DN 40 ISO-KF

Properties

- Selection of three electrodes
- Slide into mounted feedthrough
- Current connection with water cooling



Selection Data

Vacuum connection		DN 40 ISO-KF
Number of feedthroughs		1
Voltage	V	100
Current	A	250/1500 ¹⁾

¹⁾ With water cooling

Ordering Information

Feedthrough with O-ring KF40	214-141
Current connection with water cooling ²⁾	214-145
Straight electrode	214-142
Angle electrode	214-143

²⁾ Not insulated

Specifications

Tightness	mbar l/s	1×10^{-9}
Pressure (absolute)		1×10^{-8} mbar ... 2.5 bar (max. 10 bar with external centering ring)
Bakeout temperature	°C	110
Housing		aluminum 6082
Insulator		thermoplast and thermoset
Seal		FPM

DN 40 ISO KF (continued)

Dimensions

214-141

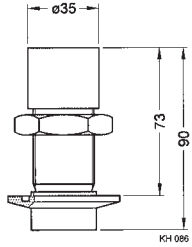

Feedthrough

214-145

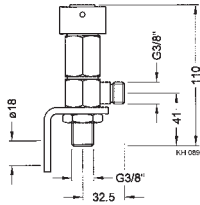

Current connection
with water cooling
copper/brass

214-142

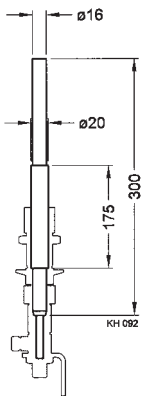

Electrodes copper/brass

214-143

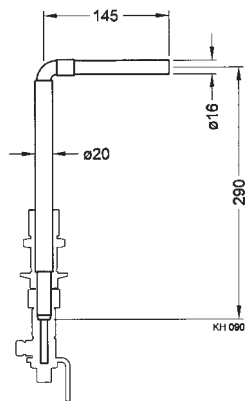

Electrodes copper/brass

Coaxial Feedthroughs ISO-KF / CF-F

BNC / MHV DN 16 – 40

Properties

- Based on MIL-C-39012A
- Voltage up to 5 kV DC
- With atmospheric connector



Selection Data

Vacuum connection	DN 16 ISO-KF	DN 16 ISO-KF	DN 16 CF-F	DN 16 CF-F	DN 40 CF-F
Number of feedthroughs	1	1	1	1	3

Ordering Information

Type	BNC	MHV	BNC	MHV	MHV
Part No.	214-151	214-152	214-155	214-156	214-157

Specifications

Voltage						
AC, 50 Hz	kV	0.35	3.5	0.35	3.5	3.5
DC	kV	0.5	5	0.5	5	5
Current	A	3	3	3	3	3
Frequency	MHz	150		150		
Impedance	Ω	50-60		50-60		
Insulation resistance at 20°C	Ω	10^{10}	10^{10}	10^{10}	10^{10}	10^{10}
Tightness	mbar l/s	1×10^{-9}	1×10^{-9}	1×10^{-10}	1×10^{-10}	1×10^{-10}
Pressure (absolute) ¹⁾		1×10^{-8} mbar to 2.5 bar	1×10^{-8} mbar to 2.5 bar	1×10^{-10} mbar to 10 bar	1×10^{-10} mbar to 10 bar	1×10^{-10} mbar to 10 bar
Housing, flange, conductor		stainless steel	stainless steel	stainless steel	stainless steel	stainless steel
Feedthrough, seal		Al ₂ O ₃	Al ₂ O ₃	Al ₂ O ₃	Al ₂ O ₃	Al ₂ O ₃
Bakeout temperature						
With connector	°C	50	50	50	50	50
Without connector	°C	200	200	400	400	400
Standard connection						
Atmospheric connector		UG 88/U	UG 932/U	UG 88/U	UG 932/U	UG 932/U
Cable		RG 58/U	RG 59/U	RB 58/U	RG 59/U	RG 59/U
Weight	kg	0.1	0.1	0.14	0.14	0.5

¹⁾ Pressure at 400°C : 2 bar

BNC / MHV DN 16 – 40 (continued)

Dimensions

214-151

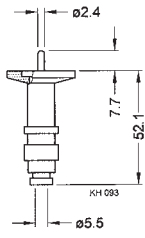

214-152

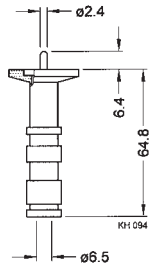

214-155

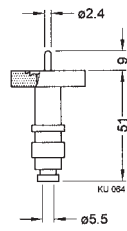

214-156

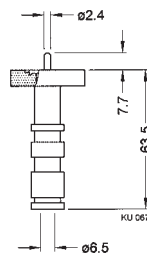

214-157

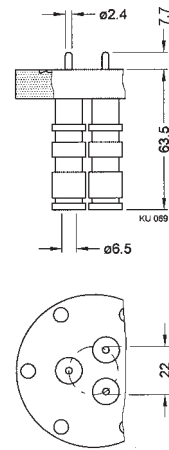

Vacuum Feedthroughs

Metal–Ceramic Connections

Properties

- High grade materials allow repeated bakings up to 400°C



Selection Data

Voltage ¹⁾	3 kV	2 kV	5 kV	10 kV
-----------------------	------	------	------	-------

Ordering Information

Part No.	214-161	214-162	214-163	214-164
----------	---------	---------	---------	---------

Specifications

Insulator		Al ₂ O ₃	Al ₂ O ₃	Al ₂ O ₃	Al ₂ O ₃
Connection					
a		Fe-Ni	Ni-Co stainless steel 304/1.4301	Ni-Co stainless steel 304/1.4301	Fe-Ni stainless steel 304/1.4301
b		Fe-Ni			
Bakeout temperature	°C	400	400	400	400
Tightness	mbar l/s	5 x 10 ⁻¹¹	5 x 10 ⁻¹¹	5 x 10 ⁻¹¹	5 x 10 ⁻¹¹
Weight	g	5	12	25	90

¹⁾ Based on VDE 0110 for air and surface-leakage in atmosphere on both sides. Higher values up to factor two are admissible in pressures <10⁻⁴ mbar.

Metal-Ceramic Connections (continued)

Dimensions

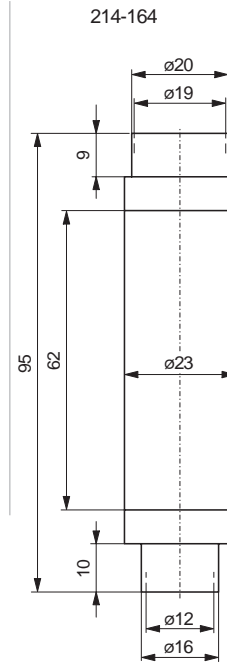
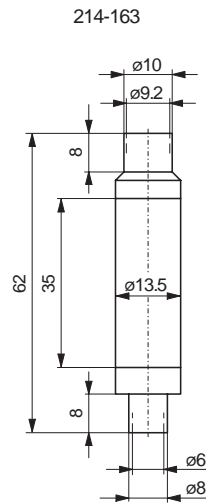
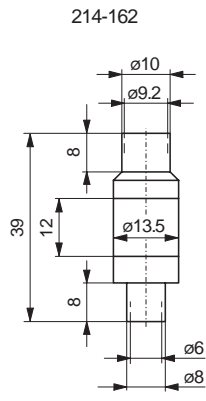
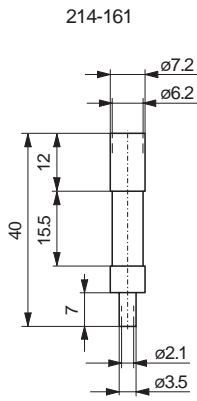

Liquid Feedthroughs ISO-KF / CF-F

DN 40

Properties

- For H₂O and LN₂
- Thermally insulated
- Specially suited for very hot and very cold applications

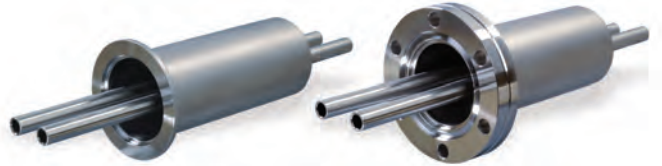

Selection Data

		DN 40 ISO-KF	DN 40 CF-F
Vacuum connection		DN 40 ISO-KF	DN 40 CF-F
Feedthrough/seal		Welded	Welded
Tube dimensions	mm	Ø 8 x 1	Ø 8 x 1
Number of tubes		2	2

Ordering Information

Part No.	214-101	214-102
----------	---------	---------

Specifications

Tightness	mbar l/s	1 x 10 ⁻⁹	1 x 10 ⁻¹⁰
Pressure		10 ⁻⁸ mbar ... 10 bar	10 ⁻⁹ mbar ... 10 bar
Temperature range	°C	-200 ... +150	-200 ... +400
Material		Stainless steel 304/1.4301	Stainless steel 304/1.4301
Weight	kg	0.3	0.3

DN 40 (continued)

Dimensions

214-101

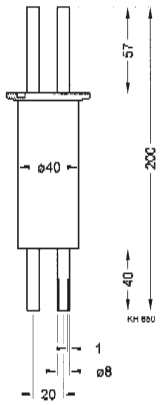

214-102

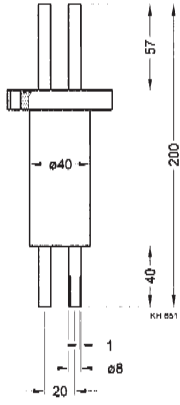

Viewports

DN 16 – DN 50 ISO-KF

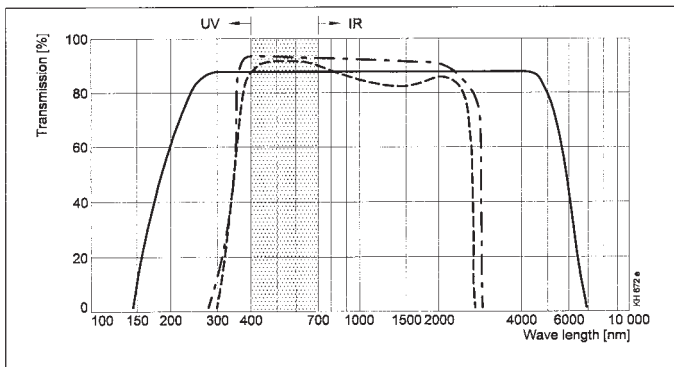

Average transmittance curve

- Saphire
- - - Kodial
- . - Borosilicate



Properties

- Wide viewing angle

Selection Data

Vacuum connection	DN16 ISO-KF	DN 25 ISO-KF	DN 40 ISO-KF	DN 50 ISO-KF
Window	borosilicate glass			
Seal	FPM			
Flange	aluminum 6082/3.2315			
Bakeout temperature	150 °C			

Ordering Information

Part No.	214-002	214-003	214-004	214-005
----------	---------	---------	---------	---------

Specifications

Tightness	mbar l/s	1 x 10 ⁻⁹			
Pressure (absolute)		1 x 10 ⁻⁹ mbar ... 4 bar			
Max. at 150°C	bar	3			
Window thickness	mm	3.8			
Weight	g	15	20	30	50

DN 16 – DN 50 ISO-KF – continued

Dimensions

214-002

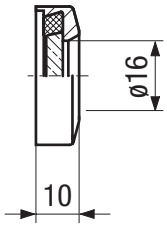

214-003

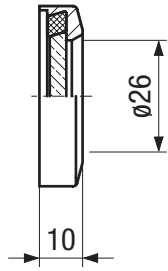

214-004

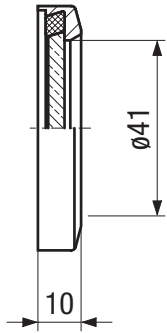

214-005

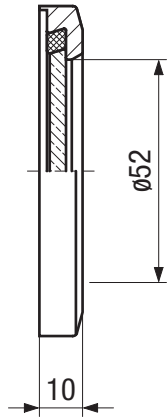

Mounting

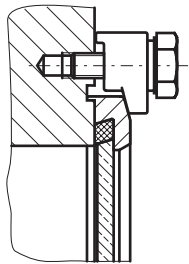
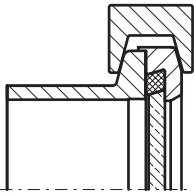

Claws, screws and
clamping ring not included

Viewports

DN 63 – DN 160 ISO-K

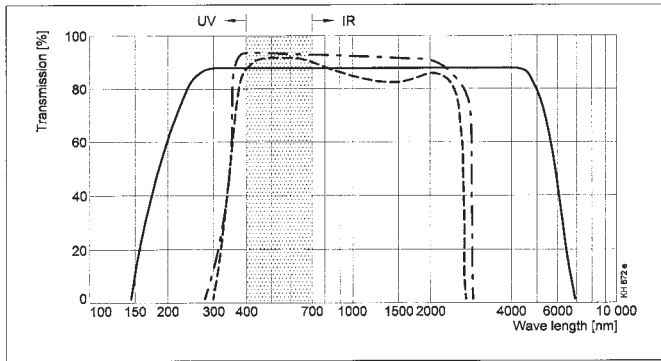

Average transmittance curve

- Sapphire
- - - Kodial
- . - Borosilicate



Properties

- Wide viewing angle
- 2011/65/EU RoHS compliant

Selection Data

Vacuum connection	DN 63 ISO-K	DN 100 ISO-K	DN 160 ISO-K
Window		Borosilicate glass	
Seal		FPM	
Flange		Aluminum 6082	
Bakeout temperature	°C	150	

Ordering Information

Part No.	214-006	214-007	214-008
----------	---------	---------	---------

Specifications

Tightness	mbar l/s	1 x 10 ⁻⁹		
Pressure (absolute)		1 x 10 ⁻⁸ mbar ... 2 bar		
Max. at 150°C	bar	1		
Window thickness	mm	6	8	10
Weight	kg	0.2	0.3	0.4

1) Claws not included

DN 63 – DN 160 ISO-K (continued)

Dimensions

[mm]

214-006

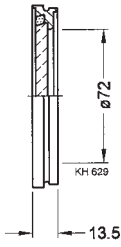

214-007

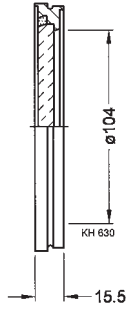

214-008

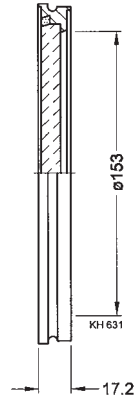

Mounting

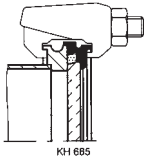

Viewports

DN 16 – DN 160 CF

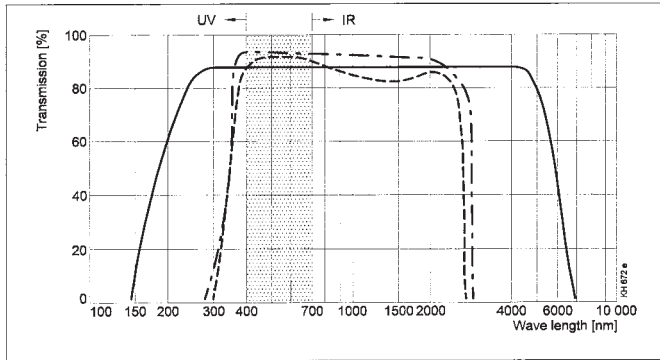

Average transmittance curve

- Sapphire
- - - Kodial
- - - Borosilicate



Properties

- ▀ Protection window
- ▀ With Fe-Ni alloy as transition material

Selection Data

Vacuum connection	DN 16 CF-F	DN 40 CF-F	DN 40 CF-F	DN 63 CF-F	DN 100 CF-F	DN 160 CF-F
Window	Kodial glass	Kodial glass	Sapphire glass	Kodial glass	Kodial glass	Kodial glass
Seal	Iron/nickel					
Flange	Stainless steel 304/1.4301					
Bakeout temperature	400 °C					

Ordering Information

Viewport	214-021	214-022	214-032	214-023	214-024	214-025
Bolt set	213-416	Standard	Standard	Standard	Standard	Standard

Specifications

Tightness	mbar l/s	5 x 10 ⁻¹¹					
Pressure (absolute)		1 x 10 ⁻¹⁰					
Min.	mbar	2					
Max.	bar	1					
Max. at 400°C	bar						
Window thickness	mm	1.5	3	3	3.5	6	8
Weight	kg	0.04	0.24	0.35	0.85	1.4	2.8

DN 16 – DN 160 CF (continued)

Dimensions

[mm]

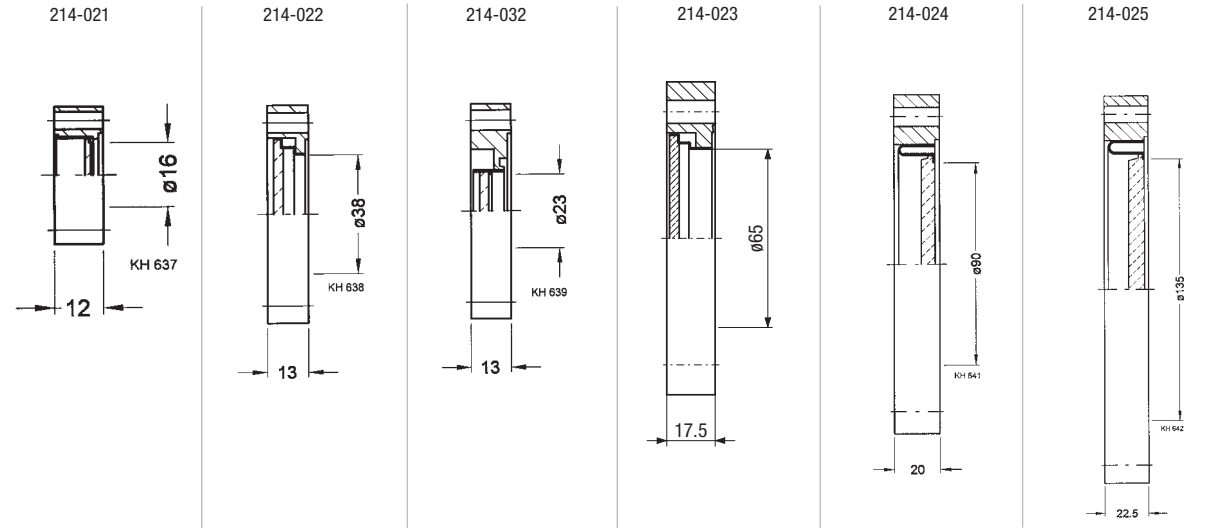

Mounting

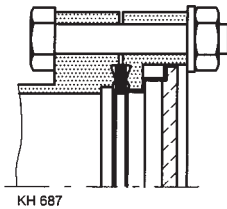

Viewports

DN 63 – DN 160 ISO-F

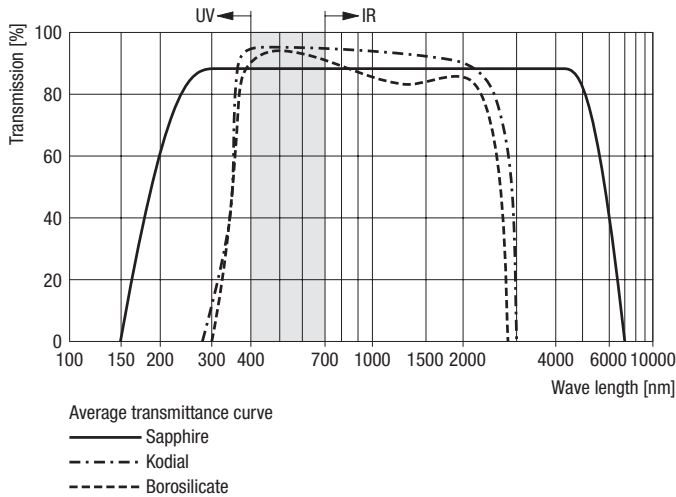

Properties

- Wide viewing angle

Selection Data

Vacuum connection	DN 63 ISO-F	DN 100 ISO-F	DN 160 ISO-F
Window		Borosilicate glass	
Seal		FPM	
Flange		Black anodized aluminum 6082	
Centering ring		Aluminum 6082	
Snap ring		Stainless steel 304/1.4301	
Bakeout temperature	°C	150	

Ordering Information

Viewport ¹⁾	Part No.	214-016	214-017	214-018
Protective glass, 5 pcs.	Part No.	214-046	214-047	214-048

¹⁾ Claws, bolts, nuts and washer included

Specifications

Tightness	mbar l/s	1 x 10 ⁻⁹		
Pressure (absolute)		1 x 10 ⁻⁸ mbar ... 2 bar		
Max. at 150°C	bar	1		
Window thickness	mm	7.5	11	15
Protective glass thickness	mm	2.3	2.3	2.3
Weight	kg	0.8	1.4	3

DN 63 – DN 160 ISO-F (continued)

Dimensions

[mm]

214-016

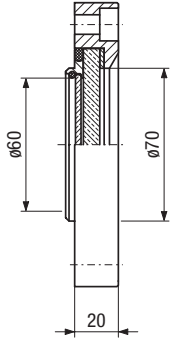

214-017

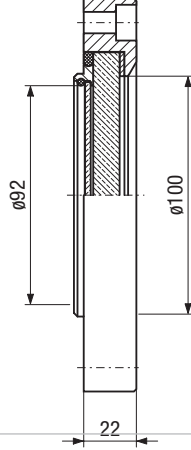

214-018

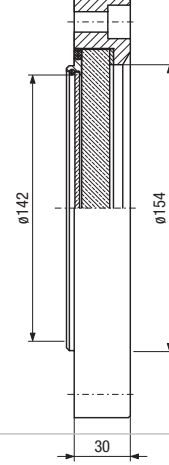

Mounting

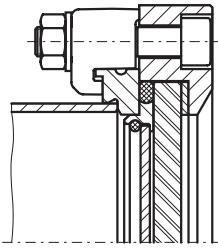

Vacuum Feedthroughs

Vacuum Ball Bearings

Properties

- Especially suited for clean vacuum applications and extreme residual gas requirements
- With shields (non-rubbing seals)
- With dry lubrication
- Bearing clearance



Selection Data

Service life ¹⁾ (revolutions)		> 20 Mio.
Pressure (absolute)	mbar	$1 \times 10^{-12} \dots 1 \times 10^{-2}$
Operating temperature ²⁾	°C	-200 ... +300
Material		
Inner ring, outer ring, balls	AISI/DIN	Stainless steel – /1.4037
Cage	AISI/DIN	Stainless steel 430 / 1.4016
Coating (dry lubrication)		
Inner ring, outer ring, cage		Wolfratherm®

¹⁾ At half load and >1000 rpm

²⁾ At -200°C reduction of tenacity

Ordering Information

Type	624	605	626	608	6000	6001
Part No.	214-211	214-212	214-213	214-214	214-215	214-216

Specifications

Rotational speed at		5000	4000	3000	2500	2000	1500
20°C	rpm	5000	4000	3000	2500	2000	1500
300°C	rpm	1500	1500	1000	800	500	300
Load capacity ¹⁾							
Static load rating (C ₀)	N	400	400	800	1000	1500	2000
Dynamic load rating (C)	N	50	50	100	150	200	250
Axial load		<<C	<<C	<<C	<<C	<<C	<<C
Fit according to ISO		G6 / f6	G6 / f6	G6 / f6	G6 / f6	G6 / f6	G6 / f6
Weight	g	3	4	8	13	20	25

¹⁾ At 20°C; half value at 300°C

Vacuum Ball Bearings (continued)

Dimensions

[mm]

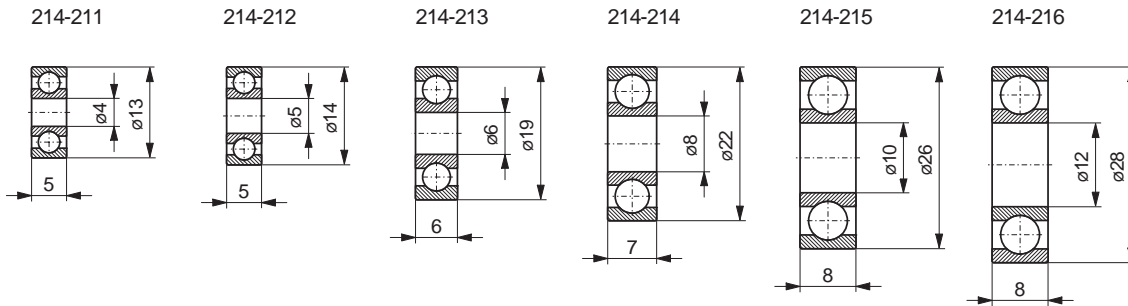

Vacuum Feedthroughs

Lubricants and Sealing Materials

High Temperature Lubricant

- Prevents seizing of stainless steel screw connections at atmosphere even at high temperatures
- Remains fully effective for at least 10 bakeout cycles



Selection Data

Temperature resistance	1000°C
In packages of	28 g

Ordering Information

Type	C 100
Part No.	214-231

Sealing Material

- For sealing small leaks

Selection Data

Temperature resistance	°C	-40 – 200
Version		Paste
In packages of	g	100

Ordering Information

Type	Rhodasil 340
Part No.	214-233

Lubricants and Sealing Materials (continued)

Vacuum Grease/Oil

- For sliding elastomer seals
- Low vapor pressure
- Good adhesiveness

Selection Data

Temperature resistance	°C	10 – 30	-40 – 200	-20 – 200	-60 – 300	-60 – 300
Vapor pressure at						
20°C	mbar	<10 ⁻⁸	<5 x 10 ⁻⁷	<10 ⁻¹²	<10 ⁻¹²	<10 ⁻¹²
100°C	mbar		<7 x 10 ⁻⁶	<10 ⁻⁷	<10 ⁻⁷	<10 ⁻⁷
In packages of		25 g	50 g	10 g	30 g	10 ml
Material		Mineral grease	Silicon grease	Fluorinated grease	Fluorinated grease with MoS ₂	Fluorinated oil

Ordering Information

Type	Apezon M	Dow Corning	FU 090	FM 090	OL 090
Part No.	214-236	214-237	214-238	214-239	214-240

Characteristics

Lubricity	Very good	Good	Good	Good/very good	Good
Resistance to					
Oxidation		Very good	Very good	Very good	Very good
Chemicals		Good	Very good	Very good	Very good
Thermal decomposition		Very good	Good	Good	Good



Vacuum Fittings

High- and Ultra-High Vacuum Components

Vacuum Fittings

Specifications

Seals	C1
Pressure Range	C1

ISO-KF Small Flange Components

Connection Elements	C2
Seals	C6
Flanges	C14
Pipe Fittings	C16
Bellows/Hose with Flanges	C19
Transition Pieces	C21
Hose, Hose Connection	C25

ISO-K Clamp Flange Components

Connection Elements	C28
Seals	C30
Flanges	C33
Pipe Fittings	C35
Bellows/Hose with Flanges	C38
Transition Pieces	C39
Protective Lids	C41

ISO-F Fixed Flange Components

Flange Components	C42
-----------------------------	-----

UHV CF Components

Connection Elements	C45
Seals	C47
Flanges	C49
Pipe Fittings	C54
Bellows/Hose with Flanges, Compensator	C57
Transition Pieces	C58
Protective Lids	C59

Inspection Documents Service

Vacuum Control	A149
--------------------------	------

Specifications

Seals

Seal Material		Temperature	Reusability
Elastomer			
NBR	°C	-30 - +90	Yes
CR	°C	-40 - +100	Yes
FPM	°C	-15 - +150	Yes
Metal			
Indium	°C	-196 - +60	Yes
Aluminum	°C	-196 - +200	No
Copper	°C	-196 - +200	No
Silver-plated copper	°C	-196 - +450	No

Pressure Range

Code Designation		Pressure Range (mbar - bar)	Tightness (mbar l/s)	Centering	Connection
ISO-KF	Aluminum	10 ⁻⁷ - 2	10 ⁻⁸	inside	Clamping ring Clamping ring Clamping element / chain clamp
		10 ⁻⁷ - 5	10 ⁻⁸	outside	
		10 ⁻⁷ - 10	10 ⁻⁸	outside	
	Stainless steel	10 ⁻⁸ - 2	10 ⁻⁹	inside	Clamping ring Clamping ring Clamping element / chain clamp
		10 ⁻⁸ - 5	10 ⁻⁹	outside	
		10 ⁻⁸ - 10	10 ⁻⁹	outside	
ISO-K	Stainless steel	10 ⁻⁸ - 2	10 ⁻⁹	inside	Clamping screw, claw grips
CF-F/R	Stainless steel	10 ⁻¹² -1	10 ⁻⁹	---	screws

ISO-KF Small Flange Components

Connection Elements

Clamping Ring Wing Nut

		DN ... ISO-KF	Part No.	A	B	C
Clamping ring half:	aluminum 380.0	10 – 16	211-001	45	61	16
Bolt:	steel nickel plated	20 – 25	211-002	55	72	16
Nut:	zinc alloy nickel plated	32 – 40	211-003	70	90	18
		50	211-004	95	123	25

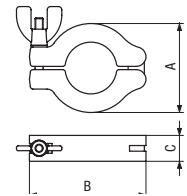

Clamping Ring Hex Nut

		DN ... ISO-KF	Part No.	A	B	C
Clamping ring half:	aluminum 380.0	10 – 16	211-611	45	61	16
Bolt and nut:	steel nickel plated	20 – 25	211-612	55	72	16
		32 – 40	211-613	70	90	18
		50	211-614	95	123	25

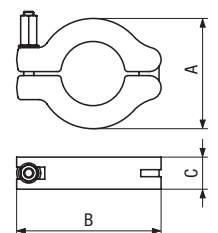

Connection Elements (continued)

Rapid Fastening Clamp

		DN ... ISO-KF	Part No.	A	B	C
Spring:	steel	10 – 16	211-005	52	70	16
Clamping ring half:	aluminum 380.0	20 – 25	211-006	61	81	16
Lever:	polyamide	32 – 40	211-007	75	98	18

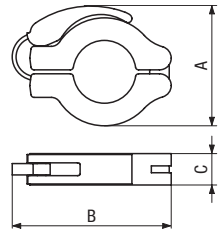

Temperature ≤80°C

Rapid Fastening Clamp All Metal

		DN ... ISO-KF	Part No.	A	B	C
Spring:	stainless steel	10 – 16	211-036	53	71	16
Clamping ring half:	aluminum 380.0	20 – 25	211-037	61	82	16
Lever:	aluminum -/3.2582	32 – 40	211-038	78	99	18

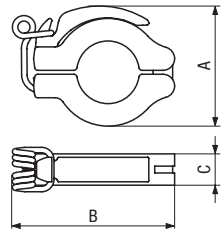

Temperature ≤150°C

Chain Clamp

		DN ... ISO-KF	Part No.	A	B	C	D*
Chain link:	aluminum 6081	10 – 16	211-021	72	52	18	2.5 / 2.5 Nm
Screw & nut & bolts:	steel 1.6582 / nitro gas carburized	20 – 25	211-022	82.5	62	18	3.5 / 3 Nm
		32 – 40	211-023	88	77	18	5 / 3 Nm
		50	211-024	119	95	20	6 / 3 Nm

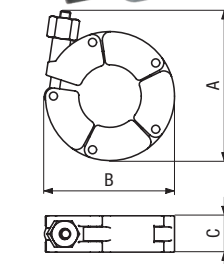

* aluminum max / elastomer max

Connection Elements (continued)

Clamping Element		DN ... ISO-KF	Part No.	A	C
Clamping Element:	aluminum 380.0	10 – 16	211-008	52	18
Bolt:	stainless steel	20 – 25	211-009	75	20
Nut:	steel zinc plated	32 – 40	211-010	90	23
		50	211-011	115	28

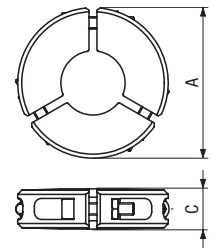

Hose Clip Clamping Ring		DN ... ISO-KF	Part No.	A	B	C
Clamping ring half:	aluminum 380.0	10 – 16	211-016	42	54	16
Band:	stainless steel	20 – 25	211-017	52	64	16
Bolt, nut & thread:	steel zinc plated	32 – 40	211-018	67	79	16

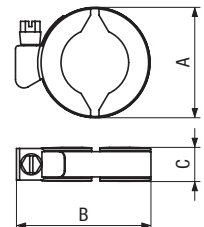

Bulkhead Clamp with Metric Screws		DN ... ISO-KF	Part No.	A	B	C	Screws
Clamping Element:	aluminum 6082	10 – 16	211-541	38.1	51	9.5	6 pcs.
Bolt:	Hexagon head screw; DIN933, A2, M5x20; silver plated	20 – 25	211-542	48	61	9.5	6 pcs.
		32 – 40	211-543	62	75	9.5	6 pcs.
		50	211-544	82.55	95	10	8 pcs.
Washer:	Washer DIN 125 A A2, 5.3/10x1						

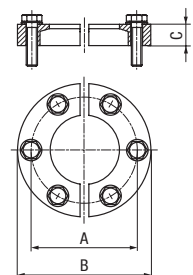

Connection Elements (continued)

Bulkhead Clamp with Inch Screws

		DN ... ISO-KF	Part No.	A	B	C	Screws
Clamping Element:	aluminum 6082	10 – 16	211-545	38.1	51	9.5	6 pcs.
Bolt:	Hexagon socket head	20 – 25	211-546	48	61	9.5	6 pcs.
	cap screw; Inox,	32 – 40	211-547	62	75	9.5	6 pcs.
	10-32 UNF x 5/8"; silver plated	50	211-548	82.55	95	10	8 pcs.
Washer:	Washer DIN 125 A A2, 5.3/10x1						

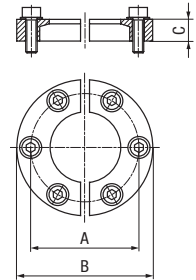

Claw Grip

		DN ... ISO-KF	Part No.	A	B	C	D	E	Set of
Claw:	aluminum 6081	10 – 50	211-015	19.5	11.5	12.5	20	14	4 pcs.
Screw & washer:	stainless steel								

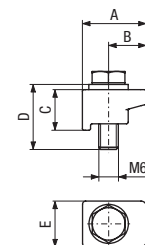

ISO-KF Small Flange Components

Seals

Centering Ring Aluminum		DN ... ISO-KF	Part No.	A	B	C	D
Ring: aluminum 6026		10	211-051	12	10	8	3.9
Seal: elastomer CR		16	211-052	17	16	8	3.9
		20	211-053	22	20	8	3.9
		25	211-054	26	25	8	3.9
		32	211-055	34	32	8	3.9
		40	211-056	41	40	8	3.9
		50	211-057	52	50	8	3.9
Ring: aluminum 6026		10	211-058	12	10	8	3.9
Seal: elastomer FPM		16	211-059	17	16	8	3.9
		20	211-060	22	20	8	3.9
		25	211-061	26	25	8	3.9
		32	211-062	34	32	8	3.9
		40	211-063	41	40	8	3.9
		50	211-064	52	50	8	3.9
Ring: aluminum 6026		10	211-651	12	10	8	3.9
Seal: elastomer NBR		16	211-652	17	16	8	3.9
		20	211-653	22	20	8	3.9
		25	211-654	26	25	8	3.9
		32	211-655	34	32	8	3.9
		40	211-656	41	40	8	3.9
		50	211-657	52	50	8	3.9
Ring: aluminum 6026		10	211-658	12	10	8	3.9
Seal: elastomer EPDM		16	211-659	17	16	8	3.9
		20	211-660	22	20	8	3.9
		25	211-661	26	25	8	3.9
		32	211-662	34	32	8	3.9
		40	211-663	41	40	8	3.9
		50	211-664	52	50	8	3.9
Ring: aluminum 6026		10	211-665	12	10	8	3.9
Seal: elastomer VMQ (silicone)		16	211-666	17	16	8	3.9
		20	211-667	22	20	8	3.9
		25	211-668	26	25	8	3.9
		32	211-669	34	32	8	3.9
		40	211-670	41	40	8	3.9
		50	211-671	52	50	8	3.9

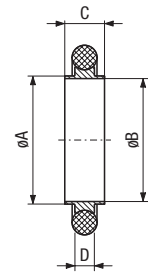

Seals (continued)

Centering Ring Stainless Steel 303

	DN ... ISO-KF	Part No.	A	B	C	D
Ring: stainless steel 303/1.4305	10	211-672	12	10	8	3.9
Seal: elastomer CR	16	211-673	17	16	8	3.9
	20	211-674	22	20	8	3.9
	25	211-675	26	25	8	3.9
	32	211-676	34	32	8	3.9
	40	211-677	41	40	8	3.9
	50	211-678	52	50	8	3.9
Ring: stainless steel 303/1.4305	10	211-065	12	10	8	3.9
Seal: elastomer FPM	16	211-066	17	16	8	3.9
	20	211-067	22	20	8	3.9
	25	211-068	26	25	8	3.9
	32	211-069	34	32	8	3.9
	40	211-070	41	40	8	3.9
	50	211-071	52	50	8	3.9
Ring: stainless steel 303/1.4305	10	211-679	12	10	8	3.9
Seal: elastomer NBR	16	211-680	17	16	8	3.9
	20	211-681	22	20	8	3.9
	25	211-682	26	25	8	3.9
	32	211-683	34	32	8	3.9
	40	211-684	41	40	8	3.9
	50	211-685	52	50	8	3.9
Ring: stainless steel 303/1.4305	10	211-686	12	10	8	3.9
Seal: elastomer EPDM	16	211-687	17	16	8	3.9
	20	211-688	22	20	8	3.9
	25	211-689	26	25	8	3.9
	32	211-690	34	32	8	3.9
	40	211-691	41	40	8	3.9
	50	211-692	52	50	8	3.9
Ring: stainless steel 303/1.4305	10	211-693	12	10	8	3.9
Seal: elastomer VMQ (silicone)	16	211-694	17	16	8	3.9
	20	211-695	22	20	8	3.9
	25	211-696	26	25	8	3.9
	32	211-697	34	32	8	3.9
	40	211-698	41	40	8	3.9
	50	211-699	52	50	8	3.9

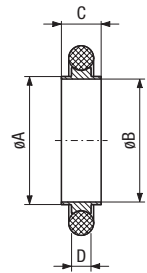

Seals (continued)

Centering Ring Stainless Steel 316L		DN ... ISO-KF	Part No.	A	B	C	D
Ring: stainless steel 316L/1.4404		10	211-735	12	10	8	3.9
Seal: elastomer CR		16	211-736	17	16	8	3.9
		20	211-737	22	20	8	3.9
		25	211-738	26	25	8	3.9
		32	211-739	34	32	8	3.9
		40	211-740	41	40	8	3.9
		50	211-741	52	50	8	3.9
Ring: stainless steel 316L/1.4404		10	211-742	12	10	8	3.9
Seal: elastomer FPM		16	211-743	17	16	8	3.9
		20	211-744	22	20	8	3.9
		25	211-745	26	25	8	3.9
		32	211-746	34	32	8	3.9
		40	211-747	41	40	8	3.9
		50	211-748	52	50	8	3.9
Ring: stainless steel 316L/1.4404		10	211-749	12	10	8	3.9
Seal: elastomer NBR		16	211-750	17	16	8	3.9
		20	211-751	22	20	8	3.9
		25	211-752	26	25	8	3.9
		32	211-753	34	32	8	3.9
		40	211-754	41	40	8	3.9
		50	211-755	52	50	8	3.9
Ring: stainless steel 316L/1.4404		10	211-756	12	10	8	3.9
Seal: elastomer EPDM		16	211-757	17	16	8	3.9
		20	211-758	22	20	8	3.9
		25	211-759	26	25	8	3.9
		32	211-760	34	32	8	3.9
		40	211-761	41	40	8	3.9
		50	211-762	52	50	8	3.9
Ring: stainless steel 316L/1.4404		10	211-763	12	10	8	3.9
Seal: elastomer VMQ (silicone)		16	211-764	17	16	8	3.9
		20	211-765	22	20	8	3.9
		25	211-766	26	25	8	3.9
		32	211-767	34	32	8	3.9
		40	211-768	41	40	8	3.9
		50	211-769	52	50	8	3.9

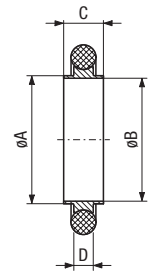

Seals (continued)

Centering Ring without O-Ring

	DN ... ISO-KF	Part No.	A	B	C
Aluminum 6026/EN AW-6026 T6	10	201-301	12	10	8
	16	201-302	17	16	8
	20	201-303	22	20	8
	25	201-304	26	25	8
	32	201-305	34	32	8
	40	201-306	41	40	8
	50	201-307	52	50	8
Stainless steel 303/1.4305	10	201-308	12	10	8
	16	201-309	17	16	8
	20	201-310	22	20	8
	25	201-311	26	25	8
	32	201-312	34	32	8
	40	201-313	41	40	8
	50	201-314	52	50	8
Stainless steel 316L/1.4404	10	201-375	12	10	8
	16	201-376	17	16	8
	20	201-377	22	20	8
	25	201-378	26	25	8
	32	201-379	34	32	8
	40	201-380	41	40	8
	50	201-381	52	50	8

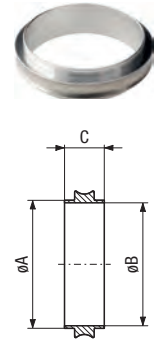

External Centering Ring

	DN ... ISO-KF	Part No.	A	B	C	D
Ring: aluminum 6026	10-16	211-081	32	30.2	7	3.9
Seal: elastomer CR	20-25	211-082	42	40.2	7	3.9
	32-40	211-083	57	55.2	7	3.9
	50	211-084	77	75.2	7	3.9
Ring: aluminum 6026	10-16	211-085	32	30.2	7	3.9
Seal: elastomer FPM	20-25	211-086	42	40.2	7	3.9
	32-40	211-087	57	55.2	7	3.9
	50	211-088	77	75.2	7	3.9
Ring: aluminum 6026	10-16	211-700	32	30.2	7	3.9
Seal: elastomer NBR	20-25	211-701	42	40.2	7	3.9
	32-40	211-702	57	55.2	7	3.9
	50	211-703	77	75.2	7	3.9
Ring: aluminum 6026	10-16	211-704	32	30.2	7	3.9
Seal: elastomer EPDM	20-25	211-705	42	40.2	7	3.9
	32-40	211-706	57	55.2	7	3.9
	50	211-707	77	75.2	7	3.9
Ring: aluminum 6026	10-16	211-708	32	30.2	7	3.9
Seal: elastomer VMQ (silicone)	20-25	211-709	42	40.2	7	3.9
	32-40	211-710	57	55.2	7	3.9
	50	211-711	77	75.2	7	3.9

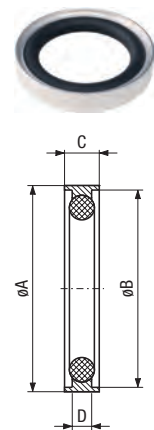

Seals (continued)

Reducing Centering Ring

	DN ... ISO-KF	Part No.	A	B	C	D	E
Ring: aluminum 6026	10 / 16	211-072	17	10	12	8	3.9
Seal: elastomer CR	20 / 25	211-073	26	20	22	8	3.9
	32 / 40	211-074	41	32	34	8	3.9
Ring: aluminum 6026	10 / 16	211-075	17	10	12	8	3.9
Seal: elastomer FPM	20 / 25	211-076	26	20	22	8	3.9
	32 / 40	211-077	41	32	34	8	3.9
Ring: aluminum 6026	10 / 16	211-712	17	10	12	8	3.9
Seal: elastomer NBR	20 / 25	211-713	26	20	22	8	3.9
	32 / 40	211-714	41	32	34	8	3.9
Ring: aluminum 6026	10 / 16	211-715	17	10	12	8	3.9
Seal: elastomer EPDM	20 / 25	211-716	26	20	22	8	3.9
	32 / 40	211-717	41	32	34	8	3.9
Ring: aluminum 6026	10 / 16	211-718	17	10	12	8	3.9
Seal: elastomer VMQ (silicone)	20 / 25	211-719	26	20	22	8	3.9
	32 / 40	211-720	41	32	34	8	3.9
Ring: stainless steel 303/1.4305	10 / 16	211-721	17	10	12	8	3.9
Seal: elastomer CR	20 / 25	211-722	26	20	22	8	3.9
	32 / 40	211-723	41	32	34	8	3.9
Ring: stainless steel 303/1.4305	10 / 16	211-078	17	10	12	8	3.9
Seal: elastomer FPM	20 / 25	211-079	26	20	22	8	3.9
	32 / 40	211-080	41	32	34	8	3.9
Ring: stainless steel 303/1.4305	10 / 16	211-724	17	10	12	8	3.9
Seal: elastomer NBR	20 / 25	211-725	26	20	22	8	3.9
	32 / 40	211-726	41	32	34	8	3.9
Ring: stainless steel 303/1.4305	10 / 16	211-727	17	10	12	8	3.9
Seal: elastomer EPDM	20 / 25	211-728	26	20	22	8	3.9
	32 / 40	211-729	41	32	34	8	3.9
Ring: stainless steel 303/1.4305	10 / 16	211-730	17	10	12	8	3.9
Seal: elastomer VMQ (silicone)	20 / 25	211-731	26	20	22	8	3.9
	32 / 40	211-732	41	32	34	8	3.9

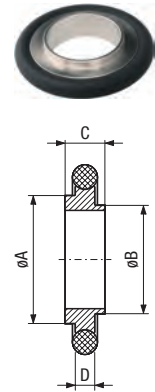

Centering Ring with Filter

	DN ... ISO-KF	Part No.	A	B	C	D	E*
Ring: stainless steel 303/1.4305	10	211-089	12	8	8	3.9	0.5m ³ /h
Seal: elastomer FPM	16	211-090	17	14	8	3.9	1.2m ³ /h
	25	211-092	26	23	8	3.9	4.2m ³ /h
Filter: stainless steel 316L/1.4404	40	211-094	41	38	8	3.9	11.3m ³ /h
	50	211-095	52	48	8	3.9	18.1m ³ /h

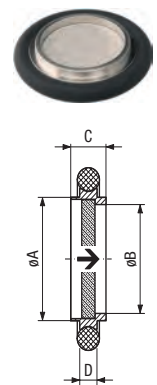

Pore size: 0.02 mm

* Air at 20°C, 200 mbar differential pressure

→ Recommended gas flow direction

Seals (continued)

Centering Ring With Fine Filter

	DN ... ISO-KF	Part No.	A	B	C	D
Inner ring: stainless steel 303/1.4305	10	211-096	12	9	8	3.9
Snab ring: stainless steel 304/1.4301	16	211-097	17	13	8	3.9
Seal: elastomer FPM	25	211-098	26	22	8	3.9
	40	211-099	41	35.5	8	3.9
Filter: stainless steel 316L/1.4404	50	211-100	52	45.7	8	3.9

Pore size: 0.004 mm
Degree of separation at 0.001 mm up to 98%

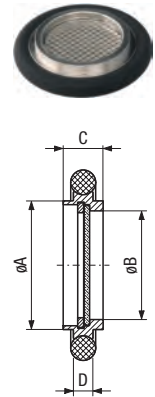

Centering Ring With Throttle

	DN ... ISO-KF	Part No.	A	B	C	D	E
Ring: aluminum 6082	16	211-622	17	13	8	3.9	6.2
Inner parts: stainless steel 301/1.4310	25	211-623	26	18	8	3.9	9
stainless steel 303/1.4305	40	211-624	41	30	8	3.9	14.3
Seal: elastomer FPM	50	211-625	52	42	8	3.9	19.9

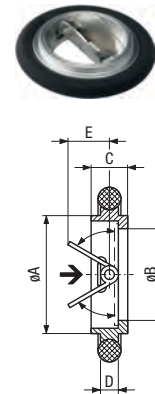

→ Recommended gas flow direction

Centering Ring with Baffle

	DN ... ISO-KF	Part No.	A	B	C
Ring: stainless steel 303 / 1.4305	20 – 25	211-113	26	25	8
Baffle: stainless steel 301 / 1.4310					
Seal: FPM					

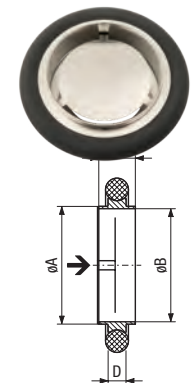

→ Recommended gas flow direction

Seals (continued)

O-Ring		DN ... ISO-KF	Part No.	A	B	Set of
Elastomer CR	10	211-146	15	5	10 pcs.	
	16	211-147	18	5	10 pcs.	
	20	211-148	25	5	10 pcs.	
	25	211-149	28	5	10 pcs.	
	32	211-150	40	5	10 pcs.	
	40	211-151	42	5	10 pcs.	
	50	211-152	55	5	10 pcs.	
Elastomer FPM	10	211-153	15	5	10 pcs.	
	16	211-154	18	5	10 pcs.	
	20	211-155	25	5	10 pcs.	
	25	211-156	28	5	10 pcs.	
	32	211-157	40	5	10 pcs.	
	40	211-158	42	5	10 pcs.	
	50	211-159	55	5	10 pcs.	

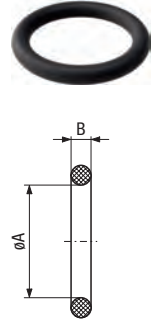

Indium Seal		DN ... ISO-KF	Part No.	A	B	C	D	E
Inner ring: stainless steel 304/1.4301	10-16	211-162	32	18	30	3.9	7	
Outer ring: aluminum 5012/-	20-25	211-163	42	28	40	3.9	7	
	32-40	211-164	57	43	55	3.9	7	
Seal: indium	50	211-165	77	63	75	3.9	7	

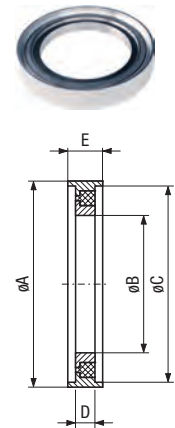

Working temperature -196° ... +60°C

Aluminum Seal		DN ... ISO-KF	Part No.	A	B	C	D	*
Aluminum annealed 6082	10-16	211-167	25.6	19.6	4.5	22.6	211-171	
	20-25	211-168	35.6	29.6	4.5	32.6	211-172	
	32-40	211-169	50.6	44.6	4.5	47.6	211-173	
	50	211-170	65.6	59.6	4.5	62.6	211-174	

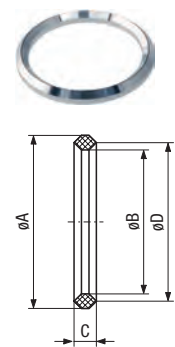

Set of 3 pieces
* With support ring

Seals (continued)

Support for Aluminum Seal		DN ... ISO-KF	Part No.	A	B	For Aluminum Seal
Stainless steel 301/1.4310	10-16	211-171	32	7	211-167	
	20-25	211-172	42	7	211-168	
	32-40	211-173	57	7	211-169	
	50	211-174	77	7	211-170	

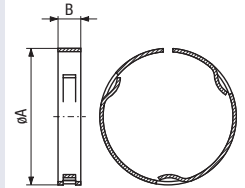

Reusable

ISO-KF Small Flange Components

Flanges

Blank Flange	DN ... ISO-KF	Part No.	A
Aluminum 6082/-	10	211-176	5
	16	211-177	5
	25	211-178	5
	40	211-179	5
	50	211-180	6
Stainless steel 304/1.4301	10	211-181	5
	16	211-182	5
	25	211-183	5
	40	211-184	5
	50	211-185	6
Stainless steel 316L/1.4404	10	211-791	5
	16	211-792	5
	25	211-793	5
	40	211-794	5
	50	211-795	6

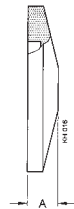

Flange with Tube, Short	DN ... ISO-KF	Part No.	A	B	C
Steel -/1.0037	10	211-201	20	12	16
	16	211-202	20	16	20
	25	211-203	20	26	30
	40	211-204	20	41	45
	50	211-205	20	51	55
Stainless steel 304/1.4301	10	211-211	20	12	16
	16	211-212	20	16	20
	25	211-213	20	26	30
	40	211-214	20	41	45
	50	211-215	20	50	54
Stainless steel 316L/1.4404	10	211-826	20	12	16
	16	211-827	20	16	20
	25	211-828	20	26	30
	40	211-829	20	41	45
	50	211-830	20	50	54

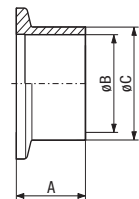

Flanges (continued)

Flange with Tube, Medium

	DN ... ISO-KF	Part No.	A	B	C
Stainless steel 304/1.4301	10	211-221	30	12	16
	16	211-222	30	16	20
	25	211-223	30	26	30
	40	211-224	30	41	45
	50	211-225	30	50	54
Stainless steel 316L/1.4404	10	211-831	30	12	16
	16	211-832	30	16	20
	25	211-833	30	26	30
	40	211-834	30	41	45
	50	211-835	30	50	54

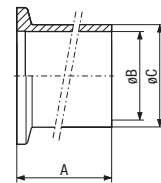

Flange with Tube, Long

	DN ... ISO-KF	Part No.	A	B	C
Steel -/1.0037	10	211-206	70	12	16
	16	211-207	70	16	20
	25	211-208	70	26	30
	40	211-209	70	41	45
	50	211-210	70	51	55
Stainless steel 304/1.4301	10	211-216	70	12	16
	16	211-217	70	16	20
	25	211-218	70	26	30
	40	211-219	70	41	45
	50	211-220	70	50	54
Stainless steel 316L/1.4404	10	211-836	70	12	16
	16	211-837	70	16	20
	25	211-838	70	26	30
	40	211-839	70	41	45
	50	211-840	70	50	54

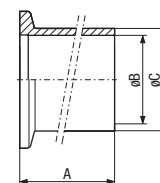

ISO-KF Small Flange Components

Pipe Fittings

Elbow 90° Aluminum

	DN ... ISO-KF	Part No.	A	B
Aluminum 6082/-	10	211-251	30	12
	16	211-252	40	16
	25	211-253	50	25
	40	211-254	65	39

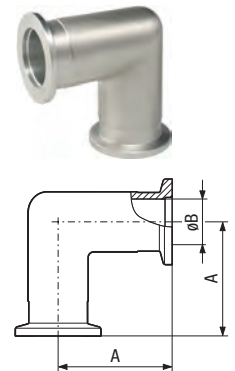

Elbow 90° Stainless Steel

	DN ... ISO-KF	Part No.	A	B
Stainless steel 304/1.4301	10	211-286	30	9
	16	211-287	40	15
	25	211-288	50	25
	40	211-289	65	40.5
	50	211-290	70	49

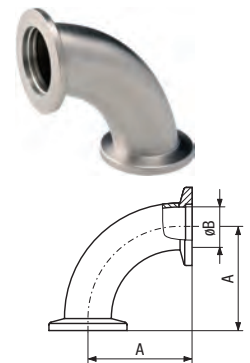

Elbow 45°

	DN ... ISO-KF	Part No.	A	B	C
Stainless steel 304/1.4301	16	211-307	13.6	55	15
	25	211-308	16.7	68.8	25
	40	211-309	15.1	87.7	37

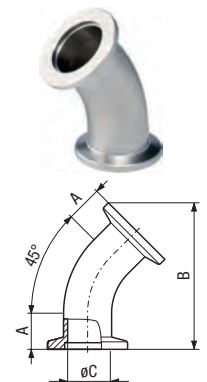

Pipe Fittings (continued)

Tee	DN ... ISO-KF	Part No.	A	B	C
Aluminum 6082/-	10	211-261	30	60	12
	16	211-262	40	80	16
	25	211-263	50	100	25
	40	211-264	65	130	39
Stainless steel 304/1.4301	10	211-291	30	60	12
	16	211-292	40	80	16
	25	211-293	50	100	25
	40	211-294	65	130	40.5
	50	211-295	70	140	53

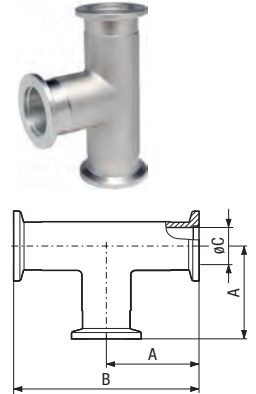

Reducing Tee	DN ... ISO-KF	Part No.	A	B	C
Stainless steel 304/1.4301	25 / 16	211-316	50	100	40
	40 / 16	211-317	65	130	40
	40 / 25	211-318	65	130	50
	50 / 16	211-319	70	140	50
	50 / 25	211-320	70	140	65
	50 / 40	211-321	70	140	65

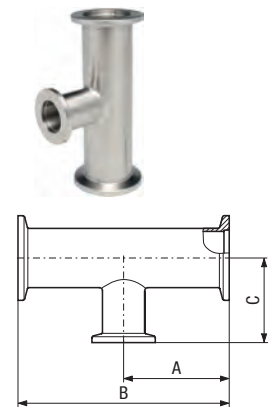

Cross	DN ... ISO-KF	Part No.	A	B	C
Aluminum 6082	10	211-266	30	60	12
	16	211-267	40	80	16
	25	211-268	50	100	25
	40	211-269	65	130	39
Stainless steel 304/1.4301	10	211-296	30	60	12
	16	211-297	40	80	16
	25	211-298	50	100	25
	40	211-299	65	130	40.5
	50	211-300	70	140	53

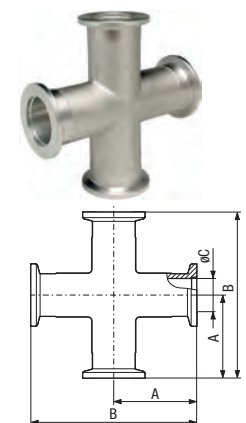

Pipe Fittings (continued)

Reducing Cross		DN ... ISO-KF	Part No.	A	B	C	D	E	F
Aluminum 6082	25 / 16		211-271	35	70	35	70	25	16
	40 / 16		211-272	40	80	45	90	39	16
Stainless steel 304/1.4301	25 / 16		211-301	35	70	35	70	25	17
	40 / 16		211-302	40	80	45	90	40.5	16
	50 / 16		211-303	50	100	50	100	53	16

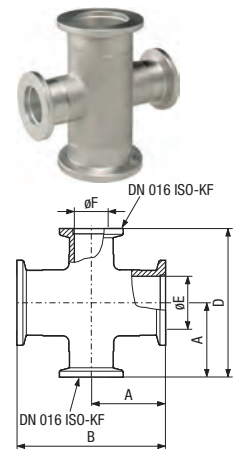

Intermediate Piece		DN ... ISO-KF	Part No.	A	B
Aluminum 6082/-	16		211-227	80	16
	25		211-228	100	25
	40		211-229	130	40
Stainless steel 304/1.4301	16		211-277	80	16
	25		211-278	100	25
	40		211-599	76.2	40.5
	40		211-279	130	40.5
	50		211-280	140	53

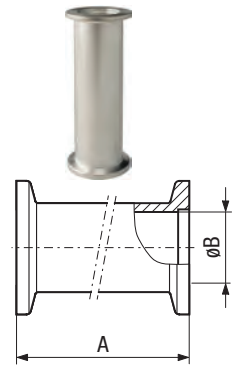

Reducer		DN ... ISO-KF	Part No.	A	B
Aluminum 6082/-	25 / 16		211-231	40	16
	40 / 16		211-232	40	16
	40 / 25		211-233	40	25
	50 / 40		211-234	40	40
Stainless steel 303/1.4305	25 / 16		211-281	40	16
	40 / 16		211-282	40	16
	40 / 25		211-283	40	26
	50 / 16		211-323	40	16
	50 / 25		211-324	40	26
	50 / 40		211-284	40	40

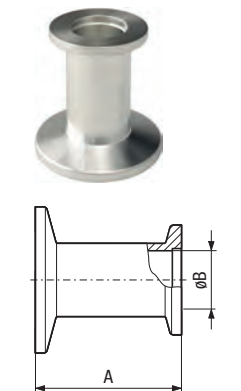

ISO-KF Small Flange Components

Bellows/Hose With Flanges

Bellows

	DN ... ISO-KF	Part No.	A	B	C	D	E
Flanges: stainless steel 304/1.4301	10	211-326	70	3.5	3	23°	5
Bellows: stainless steel 316Ti/1.4571	16	211-327	70	6.4	4.1	21°	4
	25	211-328	80	8	5	17°	3.5
	40	211-329	100	11	7	15°	7
	50	211-330	100	10	6	15°	8

Max. internal pressure: 4 bar
 A = unstressed length
 D = max. deviation from axis
 E = lateral displacement

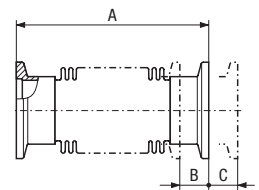

Metal Hose, High Flexible

	DN ... ISO-KF	Part No.	A	B	C	
Flanges: stainless steel 304/1.4301	10	211-331	250	100	17	
Bellows: stainless steel 316L/1.4404	10	211-332	500	100	17	
	10	211-333	750	100	17	
	10	211-334	1000	100	17	
	16	211-335	250	70	50	
	16	211-336	500	70	50	
	16	211-337	750	70	50	
	16	211-338	1000	70	50	
	16	211-531	1500	70	50	
	16	211-532	2000	70	50	
	25	211-339	250	100	60	
	25	211-340	500	100	60	
	25	211-341	750	100	60	
	25	211-342	1000	100	60	
	25	211-533	1500	100	103	
	25	211-534	2000	100	103	
	40	211-343	250	130	100	
	40	211-344	500	130	100	
	40	211-345	750	130	100	
	40	211-346	1000	130	100	
	40	211-535	1500	130	129	
	40	211-536	2000	130	129	
	50	211-347	250	200	130	
	50	211-348	500	200	130	
	B = radius for multiple bending	50	211-349	750	200	130
	C = radius for single bend	50	211-350	1000	200	130

Max. internal pressure: 4 bar
 B = radius for multiple bending
 C = radius for single bend

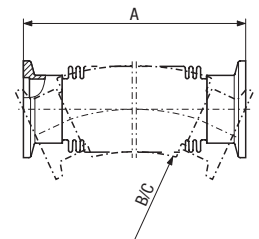

Bellows/Hose With Flanges (continued)

Metal Hose, Flexible	DN ... ISO-KF	Part No.	A	B
Flanges: 316/(304)	10	211-851	250	40
Bellows: 316L/(316Ti)	10	211-852	500	40
	10	211-853	750	40
	10	211-854	1000	40
	16	211-857	250	60
	16	211-858	500	60
	16	211-859	750	60
	16	211-860	1000	60
	16	211-861	1500	60
	16	211-862	2000	60
	25	211-863	250	115
	25	211-864	500	115
	25	211-865	750	115
	25	211-866	1000	115
	25	211-867	1500	115
	25	211-868	2000	115
	40	211-869	250	149
	40	211-870	500	149
	40	211-871	750	149
	40	211-872	1000	149
Max. internal pressure: 4 bar	40	211-873	1500	149
B = radius for single bend	40	211-874	2000	149

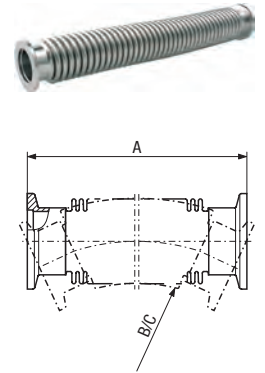

PVC Hose	DN ... ISO-KF	Part No.	A	B	C
Hose: PVC with cast in steel spiral	16	211-406	500	130	65
Nipple: aluminum 6082/-	16	211-407	1000	130	65
Hose clamp: stainless steel 430/-	16	211-509	1500	130	65
	25	211-408	500	200	100
	25	211-409	1000	200	100
	25	211-412	2000	200	100
B = radius for multiple bending	40	211-410	500	260	130
C = radius for single bend	40	211-411	1000	260	130

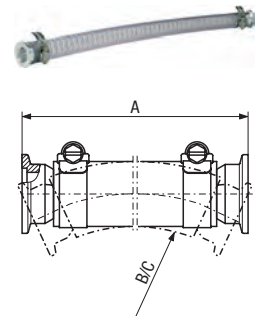

ISO-KF Small Flange Components

Transition Pieces

Adaptor ISO-KF/ISO-K

	ISO-KF/ISO-K	Part No.	A
Aluminum 6082/-	40 / 63	212-171	40
	50 / 63	212-172	45
Stainless steel 303/1.4305	40 / 63	212-173	40
	50 / 63	212-174	45
	40 / 100	212-175	40
	25 / 63	212-176	50

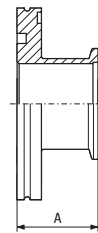

Adaptor ISO-KF/CF-F

	ISO-KF/CF-F	Part No.	A	B
Stainless steel 304L/1.4306	16 / 16	213-251	35	16
	25 / 16	213-252	35	16
	16 / 40	213-254	30	16
	25 / 40	213-255	30	26
	40 / 40	213-256	50	37
	40 / 63	213-259	35	41
	40 / 100	213-262	50	41

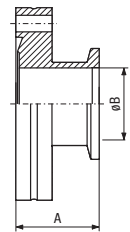

Adaptor ISO-KF/VCR Female

	ISO-KF/VCR	Part No.	A
Flange: stainless steel 304/1.4301	16 / 1/4 in.	211-359	35.8
Nut: stainless steel 316L/1.4435	25 / 1/4 in.	211-480	35.8
	25 / 1/2 in.	211-360	40.6
	40 / 3/4 in.	211-361	53.3

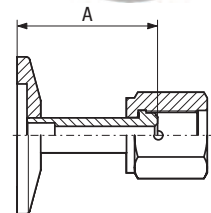
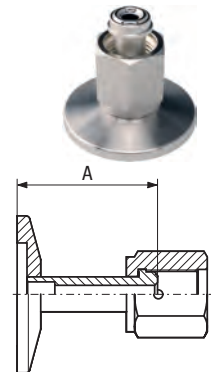

Width across flats in inch

Transition Pieces (continued)

Adaptor ISO-KF/VCR Male

	ISO-KF/VCR	Part No.	A
Flange: stainless steel 304/1.4301	16 / 1/4 in.	211-362	35.8
Nut: stainless steel 316L/1.4435	25 / 1/4 in.	211-481	35.8
	25 / 1/2 in.	211-363	40.6
	40 / 3/4 in.	211-364	53.3

Width across flats in inch

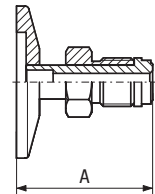

Adaptor ISO-KF/Swagelok

	ISO-KF/Swagelok	Part No.	A	B
Flange: stainless steel 304/1.4301	16 / 6 mm	211-356 ¹⁾	37	15.3
Nut: stainless steel 316L/1.4435	25 / 10 mm	211-357 ¹⁾	45	17.2
	40 / 16 mm	211-358 ¹⁾	53	24.4
	16 / 1/8 in.	211-476 ²⁾	35	12.7
	25 / 1/4 in.	211-477 ²⁾	37	15.5
	40 / 1/4 in.	211-478 ²⁾	37	15.5
	40 / 1/2 in.	211-479 ²⁾	47	23

¹⁾ Width across flats metric (SI)
²⁾ Width across flats in inch

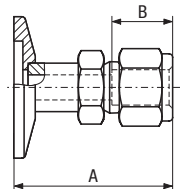

Glass Tube Connection

	DN ... ISO-KF	Part No.	A	B	C	D
Flange: aluminum 6082/-	10	211-351	50	8	10	30
Sealing: elastomer FPM	40	211-353	65	22	26	45
Tube: glas Pyrex						

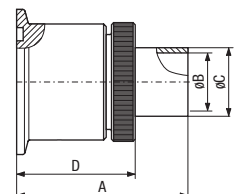

Transition Pieces (continued)

Screw-in Flange

	ISO-KF/DN	Part No.	A	B	C	D
Flange: stainless steel 303/1.4305	16 / M16x1.5	211-372	42	11.5	M16x1.5	10.5
Sealing: elastomer FPM	10 / G 3/8 in.	211-366	35	15	G 3/8 in.	12
	16 / G 1/2 in.	211-367	35	15	G 1/2 in.	16
	25 / G 1 in.	211-368	45	25	G 1 in.	25
	40 / G 1 1/2 in.	211-369	50	30	G 1 1/2 in.	41

Width across flats metric (SI)

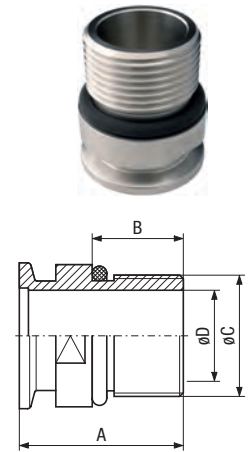

Screw-on Flange

	ISO-KF/DN	Part No.	A	B	C	D
Flange: stainless steel 303/1.4305	10 / G 3/8 in.	211-376	35	15	G 3/8 in.	10
Sealing: elastomer FPM	16 / G 1/2 in.	211-377	35	15	G 1/2 in.	15
	25 / G 1 in.	211-378	45	25	G 1 in.	24
	40 / G 1 1/2 in.	211-379	50	30	G 1 1/2 in.	38

Width across flats metric (SI)

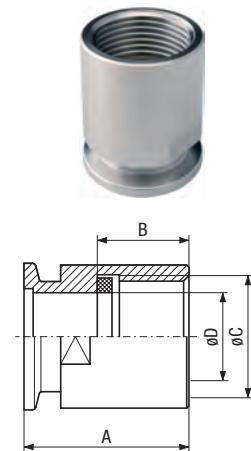

Transition Pieces (continued)

Adaptor ISO-KF/NPT Female

	ISO-KF/NPT	Part No.	A	B	C	D
Stainless steel 303/1.4305	16 / 1/8 in.	211-566	19	10	12	1/8-27 NPT
	16 / 1/4 in.	211-567	19	13	15	1/4-18 NPT
	25 / 1/8 in.	211-569	19	10	12	1/8-27 NPT
	25 / 1/4 in.	211-570	19	13	15	1/4-18 NPT
	25 / 1/2 in.	211-571	26	18	25	1/2-14 NPT
	25 / 1 in.	211-572	42	24	25	1-11 1/2 NPT
	40 / 1/4 in.	211-574	19	13	15	1/4-18 NPT
	40 / 1/2 in.	211-575	26	18	25	1/2-14 NPT
	40 / 1 in.	211-576	26	23	29	1-11 1/2 NPT

Width across flats in inch

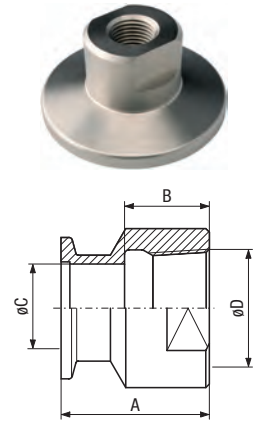

Adaptor ISO-KF/NPT Male

	ISO-KF/NPT	Part No.	A	B	C	D
Stainless steel 303/1.4305	16 / 1/8 in.	211-551	40	17	5	1/8-27 NPT
	16 / 1/4 in.	211-552	40	22	7	1/4-18 NPT
	25 / 1/8 in.	211-554	40	17	5	1/8-27 NPT
	25 / 1/4 in.	211-555	40	22	7	1/4-18 NPT
	25 / 1/2 in.	211-556	50	30	14	1/2-14 NPT
	25 / 1 in.	211-557	60	32	25	1-11 1/2 NPT
	40 / 1/4 in.	211-559	40	21	7	1/4-18 NPT
	40 / 1/2 in.	211-560	50	30	14	1/2-14 NPT
	40 / 1 in.	211-561	60	33	25	1-11 1/2 NPT
	40 / 1 1/4 in.	211-562	50	31.5	32	1 1/4-11 1/2 NPT
	40 / 1 1/2 in.	211-563	50	28	32	1 1/2-11 1/2 NPT
	40 / 2 in.	211-564	50	27	40	2-11 1/2 NPT

Width across flats in inch

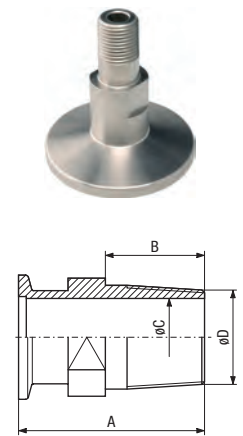

ISO-KF Small Flange Components

Hose, Hose Connection

Hose Adaptor 90°

	DN ... ISO-KF	Part No.	A	B	C	D
Aluminum 6082/-	16	211-257	40	40	16	13
	25	211-258	50	50	25	22
	40	211-259	65	65	40	37

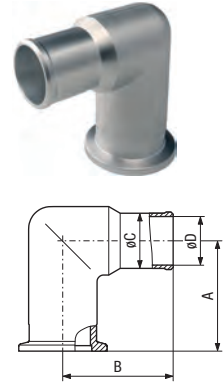

C = nominal connection for sleeve / hose

Hose Adaptor for Rubber Hose

	DN ... ISO-KF	Part No.	A	B	C
Aluminum 6082/-	16	211-387	40	7	12
	25	211-388	40	7	12
	40	211-389	40	7	12
Stainless steel 303/1.4305	16	211-392	40	7	12
	25	211-393	40	7	12
	40	211-394	40	7	12

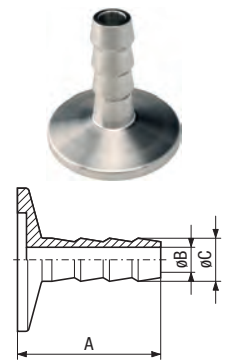

C = nominal connection for hose

Hose Connection

	DN ... ISO-KF	Part No.	A	B	C
Aluminum 6082/-	25	211-401	40	13	16
	16	211-402	40	13	16
	25	211-403	40	22	25
	40	211-404	40	37	40

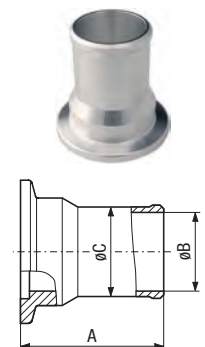

C = nominal connection for sleeve / hose

Hose, Hose Connection (continued)

Sleeve with Hose Clamp

	DN ... ISO-KF	Part No.	A	B	C	D	E
Hose clamp: stainless steel	16	211-417	58	7	14	16	44
Sleeve: elastomer CR	25	211-418	60	9	16	25	50
	40	211-419	64	13	20	40	68

Max. internal pressure: 1 bar

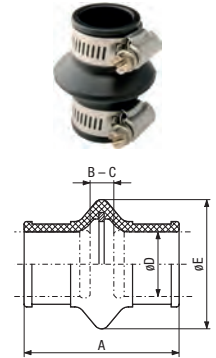

Hose Clamp

	DN ... ISO-KF	Part No.	A	B
Stainless steel 430/-	16	211-461	13	32
	25	211-462	19	44
	40	211-463	26	76

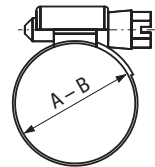

PVC Hose

	DN ... ISO-KF	Part No.	A	B	C
With cast in spiral	16	211-442	23	16	130
	25	211-443	33	25	200
	40	211-444	50	40	260

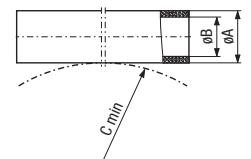

or vacuum applications
Indicate length in meters

Rubber Hose

	DN ... ISO-KF	Part No.	A	B
For vacuum applications	10	211-451	17	7
	16	211-452	25	10
	20	211-453	32	16

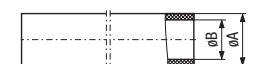

Indicate length in meters
Hardness: 45 ± 5 Shore A
Temperature: -30 ... +75 °C

Hose, Hose Connection (continued)

Protective Lid	DN ... ISO-KF	Part No.	A	B	C
Polyethylene	10-16	211-427	32	29	7.5
	20-25	211-428	42	39	7.5
	32-40	211-429	57	54	7.5
	50	211-430	77	74	7.5

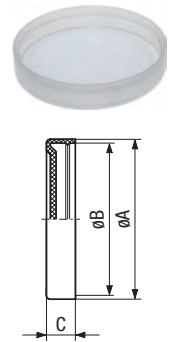

ISO-K Clamp Flange Components

Connection Elements

Clamp	DN ... ISO-K	Part No.	A	B	C	Set of	Thread
Steel zinc plated 1045/–	63-250	212-225	60	17	27	4 pcs.	M10
	320-500	212-226	78	27	39	4 pcs.	M10
	630	212-227	88	31	49	4 pcs.	
Stainless steel 316/–	63-250	212-228	61	18	28	4 pcs.	
	320-630	212-240	82	29	47	4 pcs.	

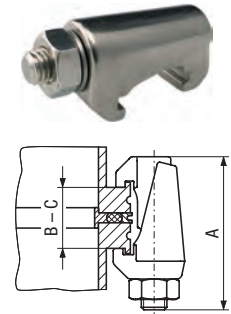

Clamp Without groove	DN ... ISO-K	Part No.	A	B	C	Set of
Clamp: aluminum 6082/– Screw: steel zinc plated 1045/–	160-250	212-432	23	35	13.9	4 pcs.
Clamp: steel zinc plated 1045/– Screw: steel zinc plated 1045/–	63-100	212-231	22.5	35	13.9	4 pcs.
	160-250	212-232	23	35	13.9	4 pcs.
	320-500	212-233	36.5	50	20.6	4 pcs.
	630	212-234	41.5	55	25.6	4 pcs.

Clamping flange and base plate without groove

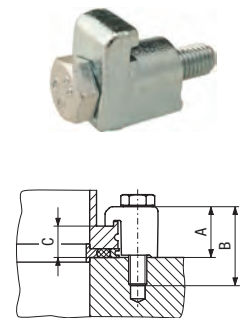

Clamp Base plate with groove	DN ... ISO-K	Part No.	A	B	C	Set of
Clamp: steel zinc plated 1045/– Screw: steel zinc plated 1045/–	63-100	212-235	18.6	30	10	4 pcs.
	160-250	212-236	19	35	10	4 pcs.
	320-500	212-237	31	45	15	4 pcs.
	630	212-233	36.5	50	20.6	4 pcs.

Clamping flange / base plate with groove

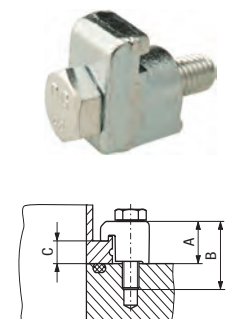

Connection Elements (continued)

Clamp Flange with groove	DN ... ISO-K	Part No.	A	B	C	Set of
Steel zinc plated 1045/-	63-100	212-247	20.6	30	12	4 pcs.
	160-250	212-248	21.1	35	12	4 pcs.
	320-500	212-249	33.9	45	18	4 pcs.
	630	212-233	36.5	50	20.6	4 pcs.
Clamping flange with groove / base plate						

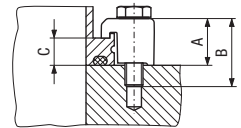

ISO-K Clamp Flange Components

Seals

Centering Ring		DN ... ISO-K	Part No.	A	B	C	D
Inner ring:	aluminum 6082/-	63	212-251	96	70	3.9	8
Outer ring:	aluminum 6082/-	80	212-091	109	83	3.9	8
Seal:	elastomer CR	100	212-252	128	102	3.9	8
		160	212-253	179	153	3.9	8
		200	212-254	239	213	3.9	8
		250	212-255	287	261	3.9	8
		320	212-256	358	318	5.6	14
		400	212-257	440	400	5.6	14
		500	212-258	541	501	5.6	14
		630	212-259	691	651	5.6	14
Inner ring:	aluminum 6082/-	63	212-261	96	70	3.9	8
Outer ring:	aluminum 6082/-	80	212-092	109	83	3.9	8
Seal:	elastomer FPM	100	212-262	128	102	3.9	8
		160	212-263	179	153	3.9	8
		200	212-264	239	213	3.9	8
		250	212-265	287	261	3.9	8
		320	212-266	358	318	5.6	14
		400	212-267	440	400	5.6	14
		500	212-268	541	501	5.6	14
		630	212-269	691	651	5.6	14
		800	212-270	840	800	5.6	14
		1000	212-271	1040	1000	5.6	14
Inner ring:	stainless steel 304/-	63	212-281	96	70	3.9	8
Outer ring:	aluminum 6082/-	80	212-093	109	83	3.9	8
Seal:	elastomer FPM	100	212-282	128	102	3.9	8
		160	212-283	179	153	3.9	8
		200	212-284	239	213	3.9	8
		250	212-285	287	261	3.9	8

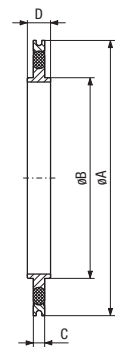

Seals (continued)

Centering Ring with Fine Filter

	DN ... ISO-K	Part No.	A	B	C	D
Inner ring: stainless steel 304/–	63	212-291	62	69.8	3.9	8
Outer ring: aluminum 6082/–	100	212-292	94	101.8	3.9	8
Seal: elastomer FPM						
Snap ring: stainless steel 304/–						
Filter grit: stainless steel 304/–						
Filter: stainless steel 316L/–						

Pore size 0.004 mm
Degree of separation at 0.001 mm up to 98%

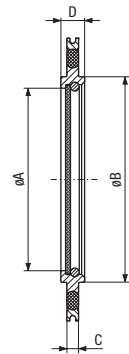

O-ring

	DN ... ISO-K	Part No.	A	B	Set of
Elastomer CR	63	212-386	75.6	5.3	5 pcs.
	80	212-387	88.3	5.3	5 pcs.
	100	212-388	107.3	5.3	5 pcs.
	160	212-389	158.1	5.3	5 pcs.
	200	212-390	208.9	5.3	5 pcs.
	250	212-391	253.4	5.3	5 pcs.
Elastomer FPM	63	212-392	75.6	5.3	5 pcs.
	80	212-393	88.3	5.3	5 pcs.
	100	212-394	107.2	5.3	5 pcs.
	160	212-395	158.1	5.3	5 pcs.
	200	212-396	208.9	5.3	5 pcs.
	250	212-397	253.4	5.3	5 pcs.
	320	212-366	329.6	7	–
	400	212-367	405.3	7	–
	500	212-368	506.9	7	–
630	212-369	658.9	7	–	

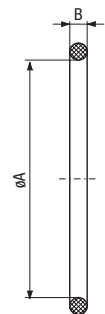

Seals (continued)

Aluminum Seal		DN ... ISO-K	Part No.	A	B	C	D	E
Aluminum annealed 6082/-		63	212-301	85.6	83	69.8	2.6	4.5
		100	212-302	116.6	114	101.8	2.6	4.5
		160	212-303	166.6	164	152.8	2.6	4.5
		250	212-305	276.6	274	260.8	2.6	4.5
Number of			Clamps	Claw Grips				
		DN 63 ISO -K	4					
		DN 100 ISO-K	6	8				
		DN 160 ISO-K	8	8				
		DN 250 ISO-K	12	12				

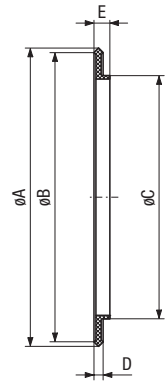

ISO-K Clamp Flange Components

Flanges

Blank Flange		DN ... ISO-K	Part No.	A	B
Aluminum 6082	63	212-441	95	12	
	100	212-442	130	12	
	160	212-443	180	12	
	200	212-444	240	12	
	250	212-445	290	12	
	320	212-446	370	17	
Steel nickel plated A570/-	63	212-001	95	12	
	100	212-002	130	12	
	160	212-003	180	12	
	250	212-005	290	12	
Stainless steel 304/-	63	212-011	95	12	
	80	212-076	110	12	
	100	212-012	130	12	
	160	212-013	180	12	
	200	212-014	240	12	
	250	212-015	290	12	
	320	212-016	370	17	
	400	212-017	450	17	
	500	212-018	550	17	
	630	212-019	690	22	

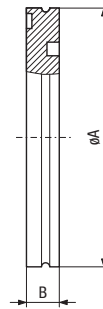

Welding Flange		DN ... ISO-K	Part No.	A	B	C	D	E
Steel -/1.0831	63	212-021	95	76.1	70.3	12	6	
	100	212-022	130	108	102.2	12	6	
Steel A570/-	160	212-023	180	159	153.2	12	6	
	250	212-025	290	267	261	12	6	
Stainless steel 304/-	63	212-031	95	76.1	71.5	12	6	
	80	212-078	110	88.9	84.9	12	6	
	100	212-032	130	108	102	12	6	
	160	212-033	180	159	155	12	6	
	200	212-034	240	219.1	213.1	12	6	
	250	212-035	290	267	261	12	6	
	320	212-036	370	324	318	17	8.5	
Stainless steel 304/-	250	212-385	290	254	250	12	6	
	250	212-505	290	273	261	12	5	

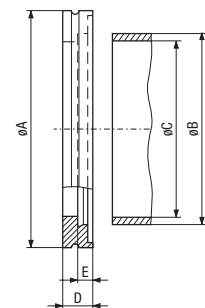

Flanges (continued)

Flange with Tube	DN ... ISO-K	Part No.	A	B	C
Flange: steel -/1.0831	63	212-041	100	76.1	70.3
Tube: steel -/1.0308	100	212-042	100	108	102.2
	160	212-043	100	159	153.2
	250	212-045	100	267	261
	Stainless steel 304/-	63	212-051	100	76.1
Stainless steel 304/-	100	212-052	100	108	104
	160	212-053	100	159	155
	200	212-054	100	219.1	212.7
	250	212-055	100	267	261
	320	212-056	100	324	318
	400	212-057	100	406	400
	500	212-058	100	508	500
	630	212-059	100	660	650
Stainless steel 304/-	250	212-506	100	273	267

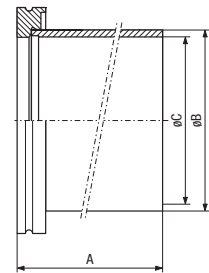

ISO-K Clamp Flange Components

Pipe Fittings

Elbow 90°

	DN ... ISO-K	Part No.	A	B
Stainless steel 304/-	63	212-101	88	66
	100	212-102	108	100
	160*	212-103	138	150
	200*	212-104	178	213
	250*	212-105	208	250
	320*	212-106	250	318

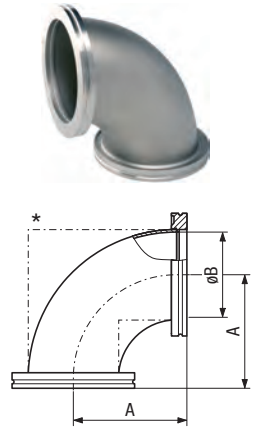

Tee

	DN ... ISO-K	Part No.	A	B
Stainless steel 304/-	63	212-111	88	66
	100	212-112	108	100
	160	212-113	138	150
	200	212-114	178	213
	250	212-115	208	250
	320	212-116	250	318

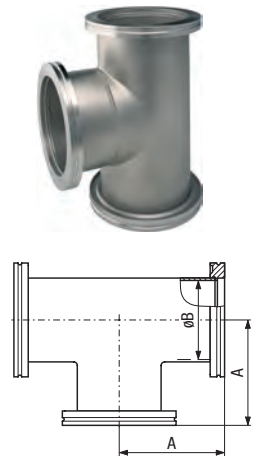

Reducing Tee

	DN ... ISO-K	Part No.	A	B	C
Stainless steel 304/-	160/63	212-196	138	276	130
	160/100	212-197	138	276	131
	250/200	212-198	190	380	208

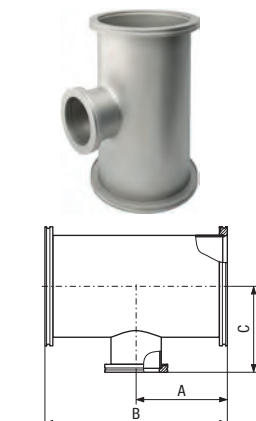

Pipe Fittings (continued)

Cross	DN ... ISO-K	Part No.	A	B
Stainless steel 304/–	63	212-121	88	66
	100	212-122	108	100
	160	212-123	138	150
	200	212-124	178	213
	250	212-125	208	250

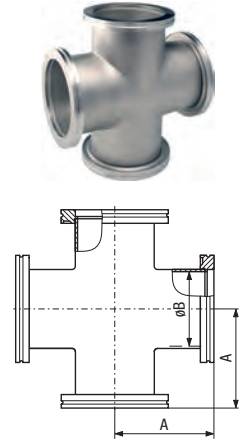

Reducing Cross	DN ... ISO-K	Part No.	A	B	C	D	E
Stainless steel 304/–	63	212-131	88	44	66	64	59
	100	212-132	100	50	82	80	77
	160	212-133	100	50	107	107	105

1 x DN 16 ISO-KF
1 x DN 25 ISO-KF
1 x DN 40 ISO-KF

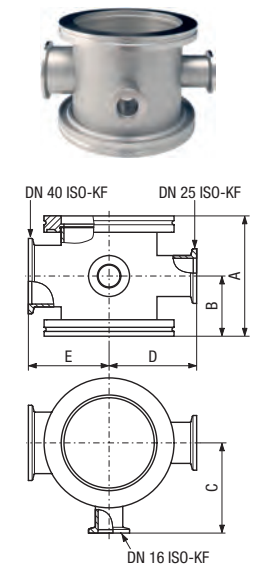

Reducer	DN ... ISO-K	Part No.	A
Stainless steel 303/–	80/63	212-084	50
	100/63	212-161	50
	160/100	212-163	50
	200/160	212-166	50
	250/160	212-169	50
	250/200	212-170	50

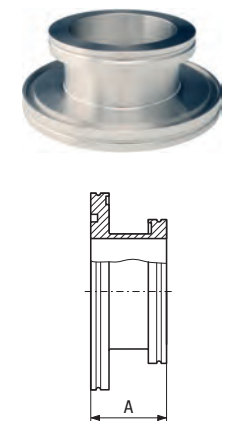

Pipe Fittings (continued)

Intermediate Piece	DN ... ISO-K	Part No.	A	B
Stainless steel 304/-	63	212-191	100	70
	63	212-192	176	70
	63	212-193	500	70

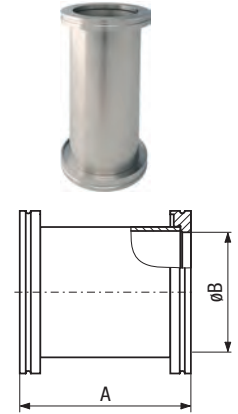

ISO-K Clamp Flange Components

Bellows/Hose With Flanges

Bellows

	DN ... ISO-K	Part No.	A	B	C	D	E
Flanges: stainless steel 304/-	63	212-201	132	20	20	66	30°
Bellows: stainless steel 316Ti/-	100	212-202	132	28	28	95	30°
	160	212-203	150	22	22	153	14°
	200	212-204	150	20	20	213	12°
	250	212-205	200	30	30	261	13°
	320	212-206	250	50	50	313	7.5°

Max. internal pressure 1.5 bar
 A = unstressed length
 E = max. deviation from axis

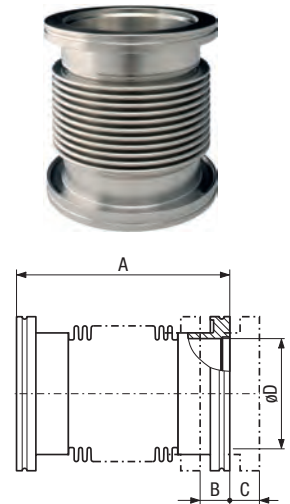

Metal Hose

	DN ... ISO-K	Part No.	A	B	C
Flanges: stainless steel 304/-	63	212-211	250	330	90
Bellows: stainless steel 316Ti/-	63	212-212	500	330	90
	63	212-213	750	330	90
	63	212-214	1000	330	90
	100	212-215	250	530	130
	100	212-216	500	530	130
	100	212-217	750	530	130
	100	212-218	1000	530	130
	160	212-222	1000	1050	215

Max. internal pressure 1.5 bar
 B = radius for multiple bending
 C = radius for single bending

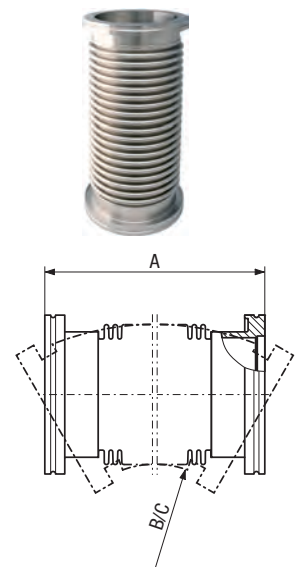

ISO-K Clamp Flange Components

Transition Pieces

Adaptor Flange ISO-K/ISO-F

	ISO-K / ISO-F	Part No.	A
Stainless steel 304/-	160/63	212-152	22
	160/100	212-153	25
	200/100	212-155	20
	200/160	212-156	25
	250/160	212-159	22

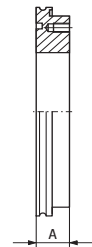

Adaptor Flange ISO-K/ISO-KF

	ISO-K / ISO-KF	Part No.	A
Aluminum 6082/-	63/40	212-171	40
	63/50	212-172	45
Stainless steel 303/-	63/25	212-176	50
	63/40	212-173	40
	63/50	212-174	45
	100/40	212-175	40

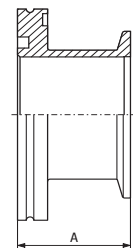

Transition Pieces (continued)

Adaptor Flange CF/ISO-K

	ISO-CF/ISO-K	Part No.	A	B	C
Stainless steel 304L/1.4306	63/63	213-271	90	1	1
	100/100	213-272	90	1	1
	160/160	213-273	90	1.5	1.5

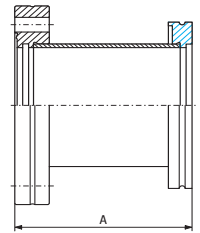

Adaptor Flange DN/ISO-K

	DN ... ISO-K	Part No.	A	B
Aluminum 6082/-	63	212-181	51	76
	100	212-182	56	107
	160	212-183	56	156

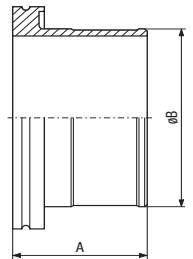

Sleeve with Hose Clamp

	DN ... ISO-KF	Part No.	A	B	C	D	E
Sleeve: elastomer CR	63	212-186	70	14	24	75	120
Hose clamp: stainless steel 304	100	212-187	72	8	26	106	150
	160	212-188	72	8	26	155	200

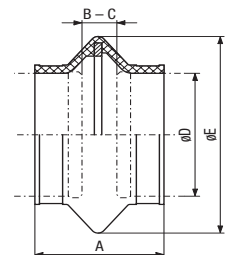

Max. internal pressure: 1 bar

ISO-K Clamp Flange Components

Protective Lids

Protective Lid	DN ... ISO-K	Part No.	A	B	C
Polyethylene	63	212-311	102	95	18
	100	212-312	137	130	18
	160	212-313	187	180	18
	200	212-314	248	240	18.5
	250	212-315	297.5	290	18.5
	320	212-316	380	370	23.5
	400	212-317	461	450	23.5
	500	212-318	557	550	24
	630	212-319	697	690	29

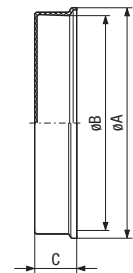

ISO-F Fixed Flange Components

Flange Components

Collar Flange with Retaining Ring

	DN ... ISO-F	Part No.	A	B	C
Flange:	63	212-061	12	95.5	130
DN 63 - 160: steel nickel plated -/1.0831	80	212-081	12	110.5	145
DN 200 - 630: steel nickel plated -/1.0037	100	212-062	12	130.5	165
	160	212-063	16	180.7	225
Retaining ring: steel nickel plated	200	212-064	16	240.7	285
	250	212-065	16	290.7	335
	320	212-066	20	370.8	425
	400	212-067	20	450.8	510
	500	212-068	20	550.8	610
	630	212-069	24	691	750



Adaptor Flange ISO-K / ISO-F

	DN ... ISO-F	Part No.	A
Stainless steel 304/1.4301	160 / 63	212-152	22
	160 / 100	212-153	25
	200 / 100	212-155	20
	200 / 160	212-156	25
	250 / 160	212-159	22

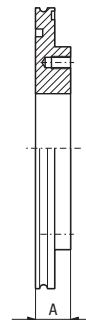
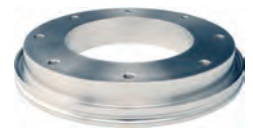

Flange Components (continued)

Measurement Flange

	DN ... ISO-F	Part No.	A	B	C
Aluminum 6082/3.2315	100	212-142	30	165	M 8
	160	212-143	30	225	M 10
Stainless steel 304/1.4301	63	212-146	30	130	M 8
	100	212-147	30	165	M 8
	160	212-148	30	225	M 10

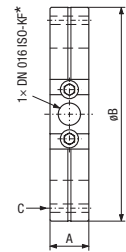

*Claw grip DN 16 ISO-KF included

Set of Hexagon Bolts

	DN ... ISO-F	Part No.	A	B	Set of
Steel zinc plated	63-100	212-241	40	M8	8 pcs.
	160-250	212-242	50	M10	12 pcs.
	320-500	212-243	70	M12	16 pcs.
	630	212-244	80	M12	20 pcs.

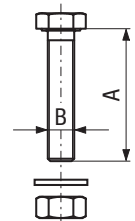

Sealing Disk

	DN ... ISO-F	Part No.	A	B	C
Disk: aluminum 6082/3.2315	63	212-321	73	3.9	98
O-Ring: elastomer CR	100	212-322	107	3.9	132
	160	212-323	160	3.9	185
	250	212-325	270	3.9	295
	320	212-326	330	5.6	375
	400	212-327	415	5.6	460
	500	212-328	515	5.6	560
	630	212-329	656	5.6	701
	800	212-330	825	5.6	870
	1000	212-331	1025	5.6	1070

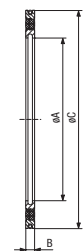

Flange Components (continued)

O-ring	DN ... ISO-F	Part No.	A	B	Set of
Elastomer CR	63	212-345	80	5	5 pcs.
	100	212-346	110	5	5 pcs.
	160	212-347	165	5	5 pcs.
	250	212-349	265	5	5 pcs.
	320	212-338	325	8	
	400	212-339	412	8	
	500	212-340	510	8	
	630	212-341	640	8	
	800	212-342	820	8	
	1000	212-343	1023	8	



UHV CF Components

Connection Elements

Hexagonal Bolts with Nuts

		DN ... CF	Part No.	A	B	Set of	C*
Bolt:	stainless steel 316/1.4401	16	213-401	20	3.2	25 x M4	3.5 Nm
Washer:	stainless steel 304/1.4301	40	213-402	35	5	25 x M6	10 Nm
Nut:	stainless steel 316/1.4401	63	213-403	45	6.5	25 x M8	20 Nm
		100	213-404	50	6.5	25 x M8	20 Nm
		160	213-405	55	6.5	25 x M8	20 Nm
		200-250	213-406	60	6.5	25 x M8	20 Nm
		300	213-408	70	8	34 x M10	30 Nm
		350	213-409	70	8	38 x M10	30 Nm

* Tightening torque

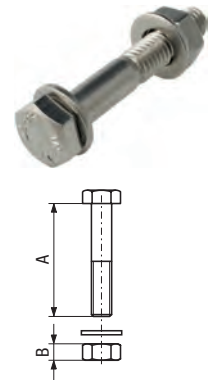

Hexagonal Bolts without Nuts

		DN ... CF	Part No.	A	Set of	B*
Bolt:	stainless steel 316/1.4401	16	213-411	16	25 x M4	4 Nm
Washer:	stainless steel 304/1.4301	40	213-412	25	25 x M6	10 Nm
		63-160	213-413	35	25 x M8	20 Nm

* Tightening torque

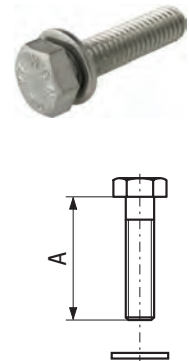

Hexagonal Bolts with Duo Nuts

		DN...CF	Part No.	A	B	C	Duo nut	D*
Bolt:	stainless steel 316/1.4401	16	213-421	20	7	4	6 x M4/3	4 Nm
Washer:	stainless steel 304/1.4301	40	213-422	35	10	5	6 x M6/3	10 Nm
Duo nut:	stainless steel 316/1.4401	63	213-423	45	12	8	8 x M8/4	20 Nm
		100	213-424	50	12	8	16 x M8/8	20 Nm
		160	213-425	55	12	8	20 x M8/10	20 Nm

* Tightening torque

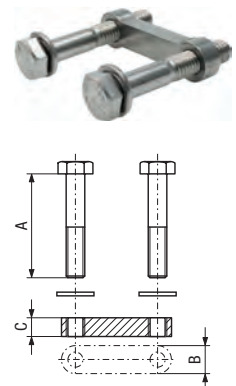

Connection Elements (continued)

Set of Stud Screws

		DN ... CF	Part No.	A	Set of	B*
Bolt:	stainless steel 316/1.4401	16	213-431	20	6 x M4	4 Nm
Washer:	stainless steel 304/1.4301	40	213-432	35	6 x M6	10 Nm
Nut:	stainless steel 316/1.4401	63-100	213-433	45	16 x M8	20 Nm

* Tightening torque

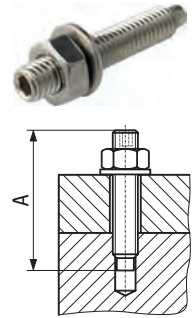

Thread Lubricant

		Part No.	Temperature resistance
C100	28g	214-231	1000°C

Remains fully effective for at least 10 bakeout cycles



UHV CF Components

Seals

Quality copper gaskets and silver plated copper gaskets are strictly designed for use in high-end UHV applications. These gaskets, made of OFHC copper, are inspected, cleaned and individually packed to ensure the highest quality.

Copper Gasket	DN ... CF	Part No.	A	B	C	Set of
High quality	16	213-451	2.1	21.3	16.2	10 pcs.
Copper OFHC -/2.0040	40	213-452	2.1	48.1	39	10 pcs.
	63	213-453	2.1	82.4	63.6	10 pcs.
	100	213-454	2.1	120.5	101.8	10 pcs.
	160	213-455	2.1	171.3	152.6	10 pcs.
	200	213-456	2.1	222.1	203.4	10 pcs.
	250	213-457	2.1	272.9	254.2	5 pcs.
	300	213-458	2.1	326.2	307	1 pcs.
	350	213-459	2.1	376.5	357	1 pcs.

Individually packed



Copper Gasket Silver Plated	DN ... CF	Part No.	A	B	C	Set of
High quality	16	213-461	2.1	21.3	16.2	10 pcs.
Copper OFHC -/2.0040	40	213-462	2.1	48.1	39	10 pcs.
Double silver plated	63	213-463	2.1	82.4	63.6	10 pcs.
	100	213-464	2.1	120.5	101.8	10 pcs.
	160	213-465	2.1	171.3	152.6	5 pcs.
	200	213-466	2.1	222.1	203.4	5 pcs.
	250	213-467	2.1	272.9	254.2	5 pcs.

Individually packed

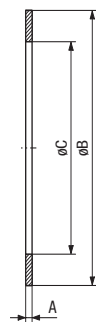

Seals (continued)

FPM Seal		DN ... CF	Part No.	A	B	C	D	Set of
Elastomer FPM	16	213-391	2	21	16			5 pcs.
	40	213-392	2.5	48.2	42			5 pcs.
	63	213-393	3.2	82.7	69.7	2.5		2 pcs.
	100	213-394	3.2	119.8	107.8	2.5		2 pcs.
	160	213-395	3.2	171.1	156	2.5		2 pcs.
	200	213-396	3.2	222.5	206	2.5		2 pcs.

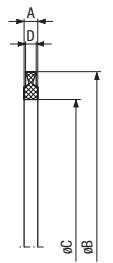
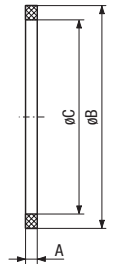

FPM Seal with Support Ring		DN ... CF	Part No.	A	B	C	D	Set of
Seal: elastomer FPM	250	213-397	5	266.5	248.3	256.2		1 pcs.
Support ring: aluminum 6082/-								

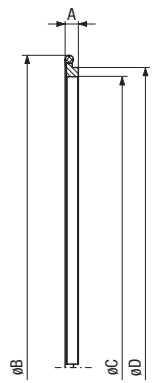

UHV CF Components

Flanges

Blank Flange		DN ... CF-F	Part No.	A	B	C
Stainless steel 304L/1.4306	16	213-001	7.5	14	1.4	
	40	213-002	13	38	1.4	
	63	213-003	17.5	66	1.4	
	100	213-004	20	104	1.4	
	160	213-005	22	155	1.4	
	200	213-006	24.5	205	1.4	
	250	213-007	24.5	256	1.4	
Stainless steel 316LN/1.4429	16	213-101	7.5	14	1.4	
	40	213-102	13	38	1.4	
	63	213-103	17.5	66	1.4	
	100	213-104	20	104	1.4	
	160	213-105	22	155	1.4	
	200	213-106	24.5	205	1.4	
	250	213-107	24.5	256	1.4	

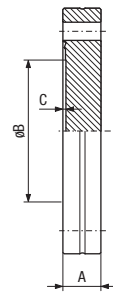

Blank Flange, Rotatable		DN ... CF-R	Part No.	A	B	C	D	E
Stainless steel 304L/1.4306	16	213-011	7.5	5.8	18.6	14	1.4	
	40	213-012	13	7.6	41	38	1.4	
	63	213-013	17.5	12.6	71	66	1.4	
	100	213-014	20	14.3	109	104	1.4	
	160	213-015	22	15.8	160	155	1.4	
	200	213-016	24.5	17.1	206	205	1.4	
	250	213-017	24.5	18	257	256	1.4	
Plate: Stainless steel 316LN/1.4429	16	213-111	7.5	5.8	18.6	14	1.4	
External ring: 304L/1.4306	40	213-112	13	7.6	41	38	1.4	
	63	213-113	17.5	12.6	71	66	1.4	
	100	213-114	20	14.3	109	104	1.4	
	160	213-115	22	15.8	160	155	1.4	
	200	213-116	24.5	17.1	206	205	1.4	
	250	213-117	24.5	18	257	256	1.4	

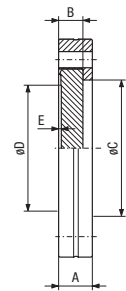

Flanges (continued)

Welding Flange		DN ... CF-F	Part No.	A	B	C	D	E
Stainless steel 304L/1.4306	16	213-021	7.5	3.3	17.2	18	1	
	40	213-022	13	7.5	39.5	40	1.5	
	63	213-023	17.5	8	66	70	2	
	100	213-024	20	9	104	108	2	
	160	213-025	22	10	155	159	2	
	200	213-026	24.5	12	205	205	2.5	
	250	213-027	24.5	12	256	256	3	
Stainless steel 316L/1.4435	300	213-028	28.5	15.8	306	306	3	
	350	213-029	28.5	15.8	356	356	3	
Stainless steel 316LN/1.4429	16	213-121	7.5	3.3	17.2	18	1	
	40	213-122	13	7.5	39.5	40	1.5	
	63	213-123	17.5	8	66	70	2	
	100	213-124	20	9	104	108	2	
	160	213-125	22	10	155	159	2	
	200	213-126	24.5	12	205	205	2.5	
	250	213-127	24.5	12	256	256	3	

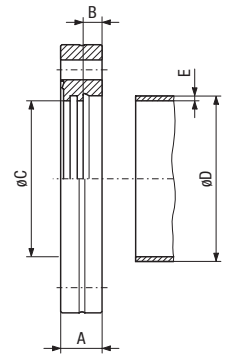

Welding Flange, Rotatable		DN ... CF-R	Part No.	A	B	C	D	E
Stainless steel 304L/1.4306	16	213-041	7.5	3.3	17.2	18	1	
	40	213-042	13	7.5	39.5	40	1.5	
	63	213-043	17.5	8	66	70	2	
	100	213-044	20	9	104	108	2	
	160	213-045	22	10	155	159	2	
	200	213-046	24.5	12	205	205	2.5	
	250	213-047	24.5	12	256	256	3	
Internal ring: Stainless steel 316LN/1.4429	16	213-141	7.5	3.3	17.2	18	1	
External ring: 304L/1.4306	40	213-142	13	7.5	39.5	40	1.5	
	63	213-143	17.5	8	66	70	2	
	100	213-144	20	9	104	108	2	
	160	213-145	22	10	155	159	2	
	200	213-146	24.5	12	205	205	2.5	
250	213-147	24.5	12	256	256	3		

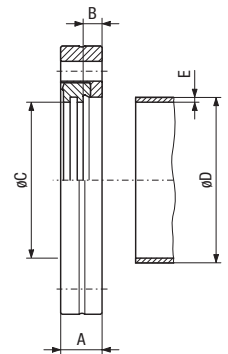

Flanges (continued)

Welding Flange with Tapped Holes

	DN ... CF-F	Part No.	A	B	C	D	E	
Stainless steel 304L/1.4306	16	213-031	7.5	3.3	17.2	18	1	6xM4
	40	213-032	13	7.5	39.5	40	1.5	6xM6
	63	213-033	17.5	8	66	70	2	8xM8
	100	213-034	20	9	104	108	2	16x M8

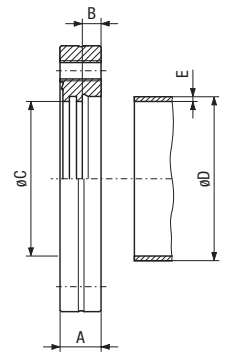

Welding Flange for Gauges

	DN ... CF-F	Part No.	A	B	C	D	E	F	G	F
Stainless steel 304L/1.4306	40	213-092	24	17	38	69.5	1.75	48	10	6xM6

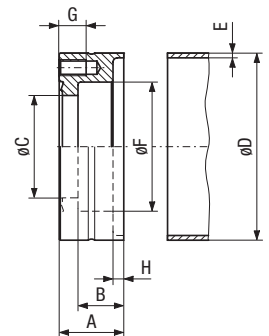

Flanges (continued)

Flange with Tube

	DN ... CF-F	Part No.	A	B	C	D
Stainless steel 304L/1.4306	16	213-051	38	17.2	18	1
	40	213-052	63	39.5	40	1.6
	63	213-053	105	66	70	2
	100	213-054	135	104	108	2
	160	213-055	167	155	159	2

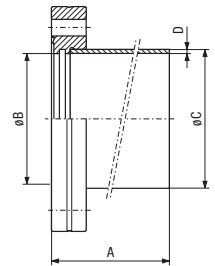

Flange with Tube, Rotatable

	DN ... CF-R	Part No.	A	B	C	D
Stainless steel 304L/1.4306	16	213-061	38	17.2	18	1
	40	213-062	63	39.5	40	1.6
	63	213-063	105	66	70	2
	100	213-064	135	104	108	2
	160	213-065	167	155	159	2

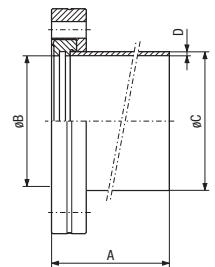

Flanges (continued)

Reducing Flange CF-F/CF-F

	DN ... CF-F	Part No.	A	B	C	D	
Stainless steel 304L/1.4306	40/16	213-071	13	16	22	5.5	6xM4
	63/40	213-073	17.5	39	50	9	6xM6
	100/40	213-075	20	39	55	9	6xM6
	100/63	213-076	20	66	85	11	8xM8
	160/40	213-078	22	39	60	9	6xM6
	160/63	213-079	24	66	85	13	8xM8
	160/100	213-080	22	104	120	11	16xM8
Stainless steel 316LN/1.4429	40/16	213-171	13	16	22	5.5	6xM4
	63/40	213-173	17.5	39	50	9	6xM6
	100/40	213-175	20	39	55	9	6xM6
	100/63	213-176	20	66	85	11	8xM8
	160/40	213-178	22	39	60	9	6xM6
	160/63	213-179	24	66	85	13	8xM8
	160/100	213-180	22	104	120	11	16xM8

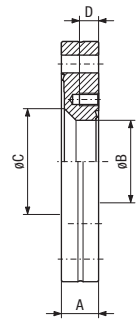

UHV CF Components

Pipe Fittings

Intermediate Piece

	DN ... CF	Part No.	A	B	C	D
Stainless steel 304L/1.4306	16	213-201	76	0.5	0.5	16
	40	213-202	126	1	1	37
	63	213-203	210	1	1	66
	100	213-204	270	1	1	104
	160	213-205	334	1.5	1.5	155

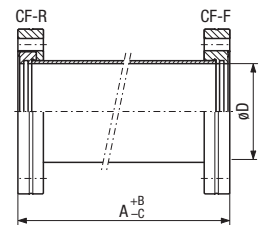

Intermediate Piece, Insulated

	DN ... CF	Part No.	A	B	C	D	E	F	G
Flanges: stainless steel 304L/1.4306	40	213-212	70	1	1	25	30	34.5	44
Insulator: ceramic Al ₂ O ₃	63	213-213	90	1	1	53	45	66	65

Transition insulator/flange: FeNi

Bakeout temperature: 350°C

G = Surface leakage 20 kV at 10⁻⁴ mbar

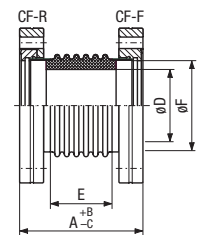

Pipe Fittings (continued)

Reducer CF-F/CF-R		DN ... CF	Part No.	A	B	C	D
Stainless steel 304L/1.4306	40/16	213-221	45	1	1	16	
	63/40	213-223	75	1	1	37	
	100/40	213-225	75	1	1	37	
	100/63	213-226	95	1	1	66	
	160/100	213-230	105	1.5	1.5	104	

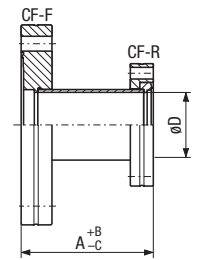

Elbow 90°		DN ... CF	Part No.	A	B	C	D
Stainless steel 304L/1.4306	16	213-301	38	0.5	0.5	15	
	40	213-302	63	0.5	0.5	38	
	63	213-303	105	1	1	66	
	100	213-304	135	1	1	100	
	160	213-305	167	1.5	1.5	150	

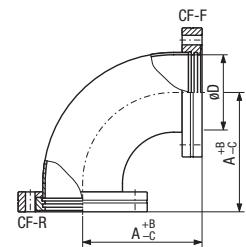

TEE		DN ... CF	Part No.	A	B	C	D
Stainless steel 304L/1.4306	16	213-311	38	0.5	0.5	15	
	40	213-312	63	0.5	0.5	38	
	63	213-313	105	1	1	66	
	100	213-314	135	1	1	100	
	160	213-315	167	1.5	1.5	150	

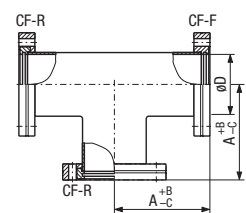

Pipe Fittings (continued)

Cross	DN ... CF	Part No.	A	B	C	D
Stainless steel 304L/1.4306	16	213-321	38	0.5	0.5	15
	40	213-322	63	0.5	0.5	38
	63	213-323	105	1	1	66
	100	213-324	135	1	1	100
	160	213-325	167	1.5	1.5	150

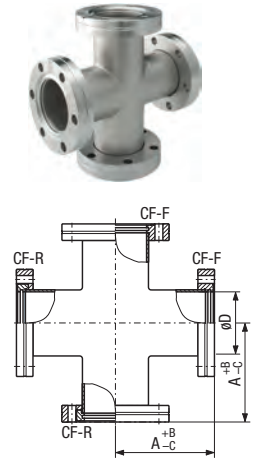

Double Cross Piece	DN ... CF	Part No.	A	B	C	D
Stainless steel 304L/1.4306	40	213-332	63	0.5	0.5	38
	63	213-333	105	1	1	66
	100	213-334	135	1	1	100
	160	213-335	167	1.5	1.5	150

3 × rotatable flanges
3 × fix flanges

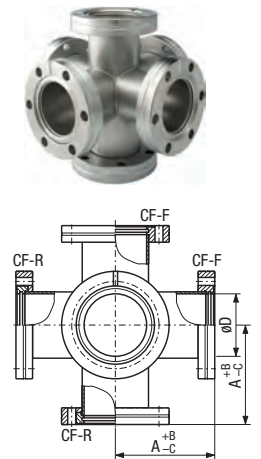

Reducing Cross	DN ... CF	Part No.	A	B	C	D	E	F
Stainless steel 304L/1.4306	100	213-342	135	1	1	67.5	106	84

2 × DN 16 CF-F
2 × DN 40 CF-F

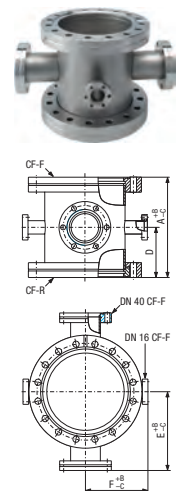

UHV CF Components

Bellows/Hose With Flanges, Compensator

Compensator

	DN...CF	Part No.	A	B	C	D	E	F	G
Flanges: stainless steel 304L/1.4306	40	213-346	120	10	0	36.8	100	10	10°
Bellows: stainless steel 316Ti/1.4571	63	213-347	130	20	0	62	154	13	12°
	100	213-348	127	30	0	92	192	13	12°

Max. internal pressure for DN 40: 4 bar
 Max. internal pressure for DN 63/100: 1.5 bar

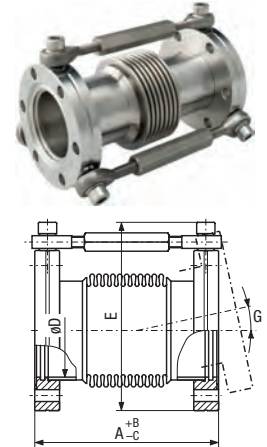

Bellows

	DN...CF	Part No.	A	B	C	D	E	F	G
Flanges: stainless steel 304L/1.4306	16	213-351	76	1.5	1.5	15	22	16	21°
Bellows: stainless steel 316Ti/1.4571	40	213-352	126	2	2	40	55	36.8	7.5°
	63	213-353	139	2	2	62	80	66	37°
	100	213-354	142	2	2	92	116	102	28°
	160	213-355	250	3	3	154	187	153	16°

A = unstressed length
 Max. internal pressure for DN 40: 4 bar
 Max. internal pressure for DN 63 ... 106: 1.5 bar

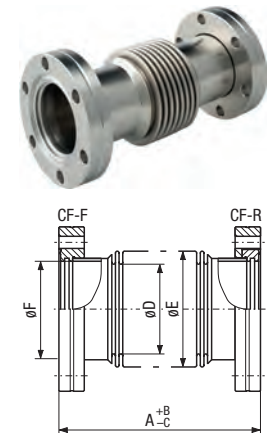

Flexible Metal Hose

	DN...CF	Part No.	A	B	C	D	E	F	G
Flanges: stainless steel 304L/1.4306	16	213-361	250	23	16	15	22.5	70	50
Bellows: stainless steel 316Ti/1.4571	16	213-362	500	23	16	15	22.5	70	50
	16	213-363	750	23	16	15	22.5	70	50
	16	213-364	1000	23	16	15	22.5	70	50
	40	213-365	250	46	36.8	40.5	53	130	100
	40	213-366	500	46	36.8	40.5	53	130	100
	40	213-367	750	46	36.8	40.5	53	130	100
	40	213-368	1000	46	36.8	40.5	53	130	100

F = radius for multiple bending
 G = radius for single bending
 Max. internal pressure: 5 bar

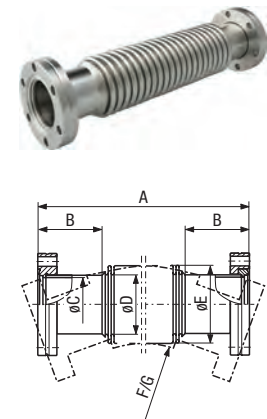

UHV CF Components

Transition Pieces

Adaptor CF-F/ISO-KF

	DN...CF-F/ISO-KF	Part No.	A	B
Stainless steel 304L/1.4306	16/16	213-251	35	16
	16/25	213-252	35	16
	40/16	213-254	30	16
	40/25	213-255	30	26
	40/40	213-256	50	37
	63/40	213-259	35	41
	100/40	213-262	50	41

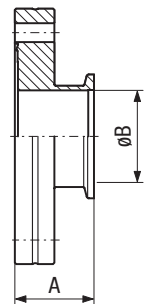

Adaptor CF-F/ISO-K

	DN ... CF-F/ISO-K	Part No.	A	B	C	D
Stainless steel 304L/1.4306	63/63	213-271	90	1	1	66
	100/100	213-272	90	1	1	104
	160/160	213-273	90	1.5	1.5	155

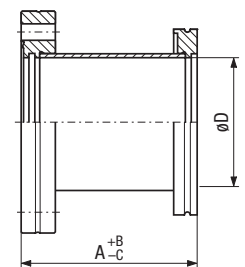

UHV CF Components

Protective Lids

Protective Lids		DN ... CF	Part No.	A	B	C
Polyethylene		16	213-441	36	34	9.5
		40	213-442	71.5	69.5	17.5
		63	213-443	115.5	113.5	22
		100	213-444	154	152	24.5
		160	213-445	205	202.5	27
		200	213-446	262	253	26.5
		250	213-447	308.5	303.5	30.9

