



Vacuum Gauge Controller

VGC083A, VGC083B



Product Identification

In all communications with INFICON, please specify the information on the product nameplate:

INFICON AG, LI-9496 Balzers Model:..... PN:..... SN:.....VDC;.....W	 
---	---

Validity

This document applies to products with part numbers:

399-700 (VGC083A, use with BAG050 or BAG055 and PGEG050)
 399-701 (VGC083B, use with BAG051 or BAG052/053 and PEG050)

The part number (PN) can be taken from the product nameplate.

If not indicated otherwise in the legends, the illustrations in this document correspond to the unit VGC083A. They apply to the VGC083B by analogy.

We reserve the right to make technical changes without prior notice.

All dimensions are indicated in mm.

Important User Information

There are operational characteristic differences between solid state equipment and electromechanical equipment. Because of these differences, and because there are a variety of uses for solid state equipment, all persons that apply this equipment must take every precaution and satisfy themselves that the intended application of this equipment is safe and used in an acceptable manner.

In no event will INFICON be responsible or liable for indirect or consequential damages that result from the use or application of this equipment.

Any examples or diagrams included in this manual are provided solely for illustrative purposes. Because of the many variables and requirements imposed on any particular installation, INFICON cannot assume responsibility or liability for any actual use based on the examples and diagrams.

No patent liability is assumed by INFICON with respect to use of information circuits, equipment, or software described in this manual.

Throughout this manual we use notes, notices and apply internationally recognized symbols and safety messages to make you aware of safety considerations.

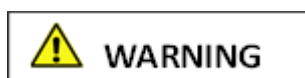

Identifies information about practices or circumstances that can cause electrical or physical hazards which, if precautions are not taken, could result in death or serious injury, property damage, or economic loss.



Identifies information about practices or circumstances that can cause electrical or physical hazards which, if precautions are not taken, could result in minor or moderate injury, property damage, or economic loss.

NOTICE

Identifies information that is critical for successful application and understanding of the product.

**SHOCK HAZARD**

Labels may be located on or inside the device to alert people that dangerous voltages may be present.

Liability and Warranty



INFICON assumes no liability and the warranty is rendered null and void if the end-user or third parties

- disregard the information in this document
- use the product in a non-conforming manner
- make any kind of interventions (modifications, alterations etc.) on the product
- use the product with accessories not listed in the corresponding product documentation.

Contents

Product Identification	2
Validity	2
Important User Information	2
Liability and Warranty	3
1 Introduction / General Information	6
1.1 VGC083A	6
1.2 VGC083B	7
2 Technical Data	8
3 Important Safety Information	11
3.1 Safety Precautions - General	11
3.2 Safety Precautions - Service and Operation	11
3.3 Electrical Conditions	13
3.3.1 Proper Equipment Grounding	13
3.3.2 Electrical Interface and Control	13
3.4 Overpressure and use with hazardous gases	13
3.5 Gases other than Nitrogen / air	14
4 Installation	15
4.1 Mechanical Installation - Controller	15
4.1.1 Panel Mount	15
4.1.2 Rack Mount	15
4.1.3 Mechanical Installation - Ionization Gauge	17
4.1.4 Mechanical Installation - Convection Gauge	17
4.2 Electrical Installation	18
4.2.1 Grounding	18
4.2.2 Installation	19
4.2.3 Connecting the Ionization Gauge Cable	19
4.2.3.1 Standard Nude, Glass and Mini IG Cables	20
4.2.3.2 Bakeable Nude IG Cable	21
4.2.3.3 Standard nude IG Cable Connector Pin Out	22
4.2.4 Connecting the PGE050 - connectors labeled "2" and "3"	23
4.2.5 Power Connection	24
4.2.6 Relay Connection	24
4.2.7 Analog Output Connection	24
4.2.8 Analog Input Connection (Capacitance Diaphragm Gauges, etc.)	24
4.2.9 Digital I/O Connection	25
4.2.10 RS232 / RS485 Serial Communications Connection	26
5 Operation - IG and CG	28
5.1 IG Emission Current	28
5.2 IG Degas	28
5.3 IG Filament Material Selection / Venting the Chamber	28
5.4 IG Over Pressure Shut Down	29
5.5 IG Over Temperature Shut Down	30
5.6 Convection Gauge (CG) Initial Setup	30
6 Setup and programming	31
6.1 Applying Power	31
6.2 Front Panel Display	31
6.3 User Interface Basics	32
6.4 Factory-Set Default Parameters	32
6.5 Programming	34
6.5.1 SETUP UNIT	35
6.5.2 ION GAUGE	36
6.5.3 CONVEC GAUGE	41
6.5.4 RELAYS	42
6.5.5 Analog Output	44
6.5.6 SERIAL COMM	49
6.5.7 DISPLAY	49

7 Analog Output Charts & Equations (Nitrogen/Air Only)	51
7.1 Analog Output wide range measurement for IG - CG1 0.5 - 7V (Nitrogen / Air only)	51
7.2 Analog Output for IG LOG N - 10 (Nitrogen / Air only)	52
7.3 Analog Output for IG LOG N - 11 (Nitrogen / Air only)	53
7.4 Analog Output for IG LOG N - 12 (Nitrogen / Air only)	54
7.5 Analog Output for IG 1.8 - 8.7 V (Nitrogen / Air only)	55
7.6 Analog Output for IG LINEAR (Nitrogen / Air only)	56
7.7 Analog Output for CG1 or CG2 1 - 8 V (Nitrogen / Air only)	56
7.8 Analog Output for CG1 or CG2 0 - 7 V (Nitrogen / Air only)	58
7.9 Analog Output for CG1 or CG2 NON - LIN (Nitrogen / Air only)	59
7.10 Analog Output for CG1 or CG2 LINEAR (Nitrogen / Air only)	61
8 Using the Gauge with Different Gases	62
8.1 Ion Gauge Display Correction Factors for Selected Gases	62
8.2 Effects of Different Gases on Convection Gauge Display	63
8.3 Effects of Different Gases on Analog Output	66
8.3.1 Ion Gauge Analog Output Correction Factors for Selected Gases	66
8.3.2 IG - CG1 0.5 - 7V Analog Output Correction Factors for Selected Gases	66
8.3.2.1 IG-CG1 0.5 - 7V Analog Output Correction Factors - Ion Gauge Range	66
8.3.2.2 IG-CG1 0.5 - 7V Analog Output Correction Factors - Convection Gauge Range	68
8.3.3 Convection gauge analog output for selected gases	68
8.3.3.1 CG1 1 - 8 V or CG2 1 - 8 V Analog Output Correction Factors - Convection Gauge	69
8.3.3.2 CG1 0 - 7 V or CG2 0 - 7 V Analog Output Correction Factors - Convection Gauge	70
8.3.3.3 CG1 NON-LIN or CG2 NON-LIN Analog Output Correction Factors - Convection Gauge	71
9 Communication Protocol (Serial Interface)	72
9.1 Device Specific Serial Communication Info	72
9.2 INFICON RS232 / RS485 Command Protocol Summary	72
9.3 INFICON RS232 and RS485 Command Protocol Summary	73
9.4 RS232 GP 307 and 358 Protocol	77
9.5 RS485 GP 307 and 358 Protocol	78
9.6 RS232 and RS485 GP 350 Protocol	79
10 Service	81
10.1 Calibration	81
10.2 Troubleshooting - IG Operation	81
10.3 Troubleshooting - IG Error Messages	82
10.4 Clearing Error Messages - IG	82
10.5 Research Screen	82
10.5.1 Research Screen (Diagnostic Display - IG)	82
10.6 Maintenance	84
11 Repair	85
12 Accessories	85
13 Storage	86
14 Disposal	86
EU Declaration of Conformity	87

For cross-references within this document, the symbol (→  XY) is used; for cross-references to further documents listed under 'Literature', use is made of the symbol (→  [Z]).

1 Introduction / General Information

1.1 VGC083A

The Vacuum Gauge Controller VGC083A is a vacuum pressure measurement system which is comprised of the following:

- The VGC083A Vacuum Gauge Controller
- One INFICON BAG050 nude UHV EB-degas Bayard-Alpert hot cathode ionization gauge (IG) or other brands of nude UHV EB-degas B-A gauges or INFICON BA055 Bayard-Alpert hot cathode Mini IG
- One or two INFICON PGE050 convection enhanced pirani heads¹⁾
- Cables to interconnect the VGC083A and point-of-use devices

¹⁾ The VGC083A will also operate the Granville-Phillips® Convectron® convection enhanced pirani vacuum gauge head.

Typical components of the complete vacuum measurement system are shown in the figure below. The VGC083A provides power and operating control for the BAG050 / 055 hot ion gauge head (IG). Additionally, it provides power and operating control for up to two enhanced convection gauges (CG).

Typical Components of the complete Vacuum Pressure Measurement System



VGC083A Vacuum Gauge Controller

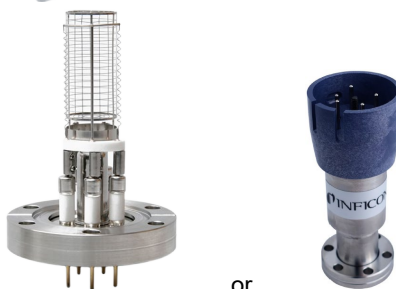

BAG050 Nude Ion Gauge
or
BAG055 Mini Ion Gauge



PGE050 Convection Gauges
1 & 2 (CVG 1 & 2)

The VGC083A, a controller unit capable of controlling multiple gauge heads, is either rack or instrument panel mountable. Optional industry standard 19-inch, 2U high rack-mount panels are available to mount the unit into rack enclosures. For important information about the PGE050 convection gauge please refer to the PGE050 Operating Manual. Read the Operating Manuals in their entirety for any device you intend to connect to the VGC083A prior to connecting and using the external devices and cables that the VGC083A is intended to be used with.

1.2 VGC083B

The Vacuum Gauge Controller VGC083B is a vacuum pressure measurement system which is comprised of the following:

- The VGC083B Vacuum Gauge Controller
- One INFICON BAG051 nude or BAG052 / 053 glass I²R Bayard-Alpert hot cathode ionization gauge or other equivalent brands of I²R glass/nude B-A gauges
- One or two INFICON PGE050 convection enhanced pirani heads¹⁾
- Cables to interconnect the VGC083B and point-of-use devices

¹⁾ The VGC083B will also operate the Granville-Phillips® Convectron® convection enhanced pirani vacuum gauge head.

Typical components of the complete vacuum measurement system are shown in the figure below. The VGC083B provides power and operating control for either the BAG051 or BAG052 / 053 ion gauge heads (IG). Additionally, it provides power and operating control for up to two enhanced convection gauges (CG).

Typical Components of the complete Vacuum Pressure Measurement System



The VGC083B, a controller unit capable of controlling multiple gauge heads, is either rack or instrument panel mountable. Optional industry standard 19-inch, 2U high rack-mount panels are available to mount the unit into rack enclosures. For important information about the PGE050 convection gauge please refer to the PGE050 Operating Manual. Read the Operating Manuals in their entirety for any device you intend to connect to the VGC083B prior to connecting and using the external devices and cables that the VGC083B is intended to be used with.

2 Technical Data

Measurement range	VGC083A	
	with BAG050	$2 \times 10^{-11} \dots 1 \times 10^{-3}$ Torr
	with BAG055	$1 \times 10^{-9} \dots 5 \times 10^{-2}$ Torr
	with PGE050	$1 \times 10^{-4} \dots 1000$ Torr
	VGC083B	
	with BAG051 or BAG052/053	$4 \times 10^{-10} \dots 1 \times 10^{-3}$ Torr
	with PGE050	$1 \times 10^{-4} \dots 1000$ Torr
	Units of measurement	Torr, mbar, Pa (user selectable)
Display	Pressure indication	LED - 3 independent pressure display channels, 3 digit plus 2 digit exponent per channel
	Set-up & programming screen	OLED - displays state of all setpoint relays, IG emission current, error messages for fault conditions
Functionality	VGC083A	
	1 (IG)	powers & operates one INFICON BAG050 nude UHV EB-Degas B-A hot cathode or other equivalent brands or INFICON BAG055 Mini IG
	2, 3 (CG)	powers & operates up to 2 INFICON PGE050 convection or Granville-Phillips® (GP) Convectron®
	VGC083B	
	1 (IG)	powers & operates one BAG051 or BAG052 / 053 or other equivalent brands of glass or nude I ² R B-A hot cathode
	2, 3 (CG)	powers & operates up to 2 INFICON PGE050 convection or Granville-Phillips® (GP) Convectron®
IG sensor control	IG sensor on/off, degas on/off and emission current can all be controlled via front panel soft-keys, remote input signals (digital I/O) or serial communications. IG sensor can also be automatically turned on/off using measurements from one of the user selectable convection or alternate gauges.	
IG remote input signals (digital I/O)	IG sensor on/off, degas on/off and emission current can also be set by applying momentary continuity to ground. Also the 9-pin D-sub remote input DIGITAL I/O connector provides pin-pin compatible signals with the GP 358 controller as well as compatible signals with the GP 307.	
Setpoint relays	Number	6 single-pole, double-throw (SPDT), user assignable to any of the gauges
	Contact rating	5 A at 30 V (dc), 5 A at 250 V (ac), resistive load

Analog output	IG analog output Log-linear	0 ... 10 V (dc), 1 V/decade, or 1.7 ... 9.3 V (dc) (nominal 1.8 ... 8.7 V (dc)), 0.8 V/decade
	Linear	0 ... 10 V (dc) (useable over 3 decades)
	Combination IG + CG analog Log-linear	0.5 ... 7 V (dc), 0.5 V/decade
	CG analog output Log-linear	1 ... 8 V (dc), 1 V/decade, or 0 ... 7 V (dc), 1 V/decade
	Linear	0 ... 10 V (dc) (useable over 3 decades)
	Non-linear analog S-curve	0.375 ... 5.659 V (dc)
Analog input	CDG	one 0 ... 10 V (dc) analog input signal from a CDG when used as an alternate gauge to CG2, or analog input from one of the following INFICON modules: PGE300, PGE500, BAG302
Serial communications	Protocol	RS485 / RS232 - ASCII protocol
Status output	<p>IG sensor on/off status message is displayed on the front panel, by serial communications and by SPDT relay (DIGITAL I/O Connector) rated at 1 A at 30 V (dc) resistive, or 1 A at 30 V (ac) non-inductive.</p> <p>IG degas on/off status or IG error conditions are displayed on the front panel, by serial communications and by an open collector transistor output (ground emitter) rated at 40 V max. VCE, 50 mA IC max.</p>	
IG (Ionization Gauge)	IG filament switching	User selectable between filament 1 or 2 using the front panel soft-keys or RS232 / RS485 serial comm
	IG emission current BAG050 / 051 / 052 / 053	100 μ A, 4 mA, 10 mA automatic switching of emission current (auto ranging)
	BAG055	100 μ A, 4 mA or automatic switching of emission current (auto ranging)
	IG degas VGC083A with BAG050 VGC083A with BAG055 VGC083B with BAG051 / 052 / 053	40 W, electron bombardment 3 W, electron bombardment 40 W, resistive
	IG overpressure protection BAG050 / 051 / 052 / 053	Ion gauge turns off at the following default settings: 1×10^{-3} Torr at 100 μ A emission current 5×10^{-4} Torr at 4 mA emission current 1×10^{-4} Torr at 10 mA emission current
	BAG055 Mini IG	5×10^{-2} Torr at 100 μ A emission current 1×10^{-3} Torr at 4 mA emission current

Ambience	Temperature	
	Operation	0 ... +40 °C
	Storage	-40 ... +50 °C
	Relative humidity	0 ... 95, non-condensing
	Altitude	
	Operating	max. 2500 m (8200 ft.)
	Storage	max. 12500 m (41000 ft.)
Pollution degree	II	
Degree of protection	IP20	

Housing	Housing	aluminum extrusion - black powder paint finish
---------	---------	--

Mains specifications	Voltage	
	Used with BAG050 / 051, BAG052 / 53	20 ... 28 V (dc), 200 W protected against power reversal and transient over-voltages
	Used with BAG055	20 ... 28 V (dc), 36 W protected against power reversal and transient over-voltages
	Connectors	gauge cable assemblies provided by INFICON
	IG & CG	9-pin D-sub male
	Digital I/O	
	Serial communications	
	RS232	9-pin D-sub female
	RS485	9-pin D-sub male
	analog I/O, setpoint relays, power	pluggable terminal block (mating connectors included)

Dimensions
VGC083A, VGC083B

mm (inch)

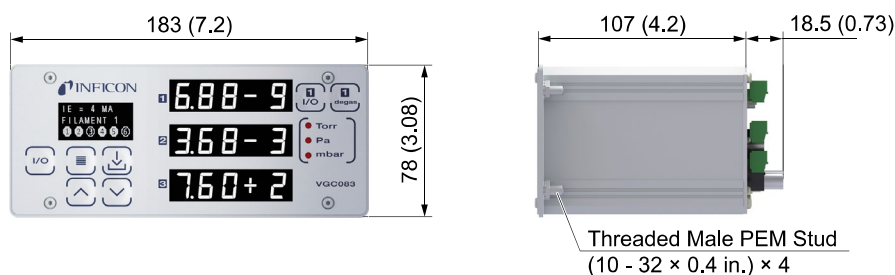

Weight
VGC083A, VGC083B

0.7 kg (1.7 lb.)

3 Important Safety Information

INFICON has designed and tested this product to provide safe and reliable service, provided it is installed and operated within the strict safety guidelines provided in this manual. **Please read and follow all warnings and instructions.**



WARNING

To avoid serious injury or death, follow the safety information in this document. Failure to comply with these safety procedures could result in serious bodily harm, including death, and or property damage.

Failure to comply with these warnings violates the safety standards of installation and intended use of this instrument. INFICON disclaims all liability for the customer's failure to comply with these instructions.

Although every attempt has been made to consider most possible installations, INFICON cannot anticipate every contingency that arises from various installations, operation, or maintenance of the instrument. If you have any questions about the safe installation and use of this product, please contact INFICON.

This device meets FCC part 15 requirements for an unintentional radiator, class A.

3.1 Safety Precautions - General

Hazardous voltages are present with this product during normal operation. The product should never be operated with the covers removed unless equivalent protection of the operator from accidental contact with hazardous internal voltages is provided.



WARNING! There are no operator serviceable parts or adjustments inside the product enclosure. Refer servicing to service trained personnel.

Do not modify this product or substitute any parts without authorization of qualified INFICON service trained personnel. Return the product to an INFICON qualified service and repair center to ensure that all safety features are maintained. Do not use this product if unauthorized modifications have been made.



WARNING! Source power must be removed from the product prior to performing any servicing.

After servicing this product, ensure that all safety checks are made by a qualified service person. When replacement parts are required, ensure that the parts are specified by INFICON. Substitutions of non-qualified parts may result in fire, electric shock or other hazards. Use of unauthorized parts or modifications made to this product will void the warranty.

To reduce the risk of fire or electric shock, do not expose this product to rain or moisture. These products are not waterproof and careful attention must be paid to not spill any type of liquid onto these products. Do not use these products if they have been damaged. Immediately contact INFICON to arrange return of the product if it is damaged.

Due to the possibility of corrosion when used in certain environmental conditions, it is possible that the product's safety could be compromised over time. It is important that the product be periodically inspected for sound electrical connections and equipment grounding. Do not use if the equipment grounding or electrical insulation has been compromised.

3.2 Safety Precautions - Service and Operation

Ensure the enclosure of the unit is connected directly to a good quality earth ground.

Ensure that the vacuum port on which the vacuum gauge sensors are mounted is electrically grounded.

When using the BAG050 / 051 / 052 / 053 use a power source of 20 ... 28 V (dc), 200 W or use INFICON series optional power supplies.

When using the BAG055 Mini IG use a power source of 20 ... 28 V (dc), 36 W or use INFICON series optional power supplies.

Turn off power to the unit before attempting to service the controller.

Turn off power to the unit if a cable or plug is damaged or the product is not operating normally according to this instruction manual. Contact qualified INFICON service personnel for any service or troubleshooting condition that may not be covered by this operating manual.

It is important that the product be periodically inspected for sound electrical connections and equipment grounding. Do not use if the equipment grounding or electrical insulation has been compromised.

Do not use if the unit has been dropped or the enclosure has been damaged. Contact INFICON for return authorization and instructions for returning the product to INFICON for evaluation.

When using the BAG050 / 051 / 052 / 053 if measured pressure exceeds the thresholds that are defined under the following conditions, the ion gauge will turn off:

- The pressure exceeds 1.00×10^{-3} Torr at 100 μ A emission current.
- The pressure exceeds 5.00×10^{-4} Torr at 4 mA emission current.
- The pressure exceeds 1.00×10^{-4} Torr at 10 mA emission current.

When using the BAG055 Mini IG if measured pressure exceeds the thresholds that are defined under the following conditions, the ion gauge will turn off:

- The pressure exceeds 5.00×10^{-2} Torr at 100 μ A emission current.
- The pressure exceeds 1.00×10^{-3} Torr at 4 mA emission current.

During the Degas cycle, if the measured pressure exceeds 1.00×10^{-4} Torr when using the BAG050 / 051 / 052 / 053, or if the measured pressure exceeds 4.00×10^{-3} Torr when using the BAG055, Degas will turn off but the filament will remain turned on.

Ensure vacuum level is less than 5.00×10^{-5} Torr before attempting to initiate Degas of the BAG05x series ionization gauge heads.

Do not attempt to turn the IG on if the pressure is near the threshold limits defined here.

NOTICE Never use an auxiliary or convection gauge to automatically turn off the Ion Gauge when the Ion Gauge filament in use is constructed of **tungsten**. The response time of other gauges may not allow for timely turn off of the **tungsten** filament possibly leading to filament damage. Always turn off the IG filament (tungsten) manually before pressure is allowed to rise above 1.00E-03 (1.00×10^{-3}) Torr.

If you are using dual filament IGs, it is highly recommended to periodically alternate operating the ion gauge filaments 1 and 2. An inactive filament not operating for an extended period of time may result in failure of that filament to establish and maintain emission current in applications where the filament coating may become contaminated by residual application or process related chemistries.

The most common cause of all vacuum gauge failures is contamination of the sensor or head electrodes. Noisy or erratic readings and total gauge head failures are all possible indications of gauge contamination. Contamination can generally be characterized as either: A) a chemical reaction of process gases with head / sensor electrodes, or B) an accumulation of material on the head (sensor) electrodes. Sensors that fail due to contamination are not covered under warranty.

After servicing these products, ensure that all safety checks are made by a qualified service person

3.3 Electrical Conditions

⚠ WARNING! When high voltage is present in any vacuum system, a life threatening electrical shock hazard may exist unless all exposed electrical conductors are maintained at earth ground potential. This applies to all products that come in contact with the gas contained in vacuum chambers. An electrical discharge within a gaseous environment may couple dangerous high voltage directly to any ungrounded conductor of electricity. A person could be seriously injured or killed by coming in contact with an exposed, ungrounded electrical conductor at high voltage potential. This condition applies to all products that may come in contact with the gas inside the vacuum chamber (vacuum/pressure containment vessel).

3.3.1 Proper Equipment Grounding

⚠ WARNING! Hazardous voltages that could seriously injure or cause death are present in many vacuum processes. Verify that the vacuum connection ports on which the ion gauge and the convection gauges are mounted are electrically grounded. Consult a qualified Electrician if you are in doubt about your equipment grounding. Proper grounding of your equipment is essential for safety as well as intended operation of the equipment. The vacuum gauge heads and enclosure of any control module must be connected directly to a good quality equipment earthing conductor. Use a ground lug on the vacuum connection flange of the pressure measurement devices if necessary.

⚠ WARNING! In order to protect personnel from electric shock and bodily harm, shield all conductors which are subject to potential high voltage electrical discharges in or around the vacuum system.

3.3.2 Electrical Interface and Control

It is the user's responsibility to ensure that the electrical signals from this product and any connections made to external devices, for example, relays and solenoids, are used in a safe manner. Always double check the system set-up before using any signals to automate your process. Perform a hazardous operation analysis of your system design and ensure safeguards and personnel safety measures are taken to prevent injury and property damage.

3.4 Overpressure and use with hazardous gases

⚠ WARNING! Install suitable protective devices that will limit the level of pressure inside your vacuum chamber to less than what the vacuum chamber system components are capable of withstanding.

In cases where an equipment failure could cause a hazardous condition, always implement fail-safe system operation. For example, use a pressure relief device in an automatic backfill operation where a malfunction could result in high internal pressures if the pressure relief device was not installed on the chamber.

The vacuum gauge heads used with this product are not intended for use at pressures above 20 psia (1000 Torr); DO NOT exceed 35 psig (< 2 ½ bars) pressure inside the sensor. If your chamber goes to higher pressures, you should install an isolation valve or pressure relief device to protect the gauge tube from overpressure conditions. With some fittings, actual safe overpressure conditions may be lower; for example, a quick-connect, O-ring compression fitting may forcibly release the gauge tube from the vacuum chamber fitting with only a few psi over local uncorrected barometric (atmospheric) pressure.

⚠ CAUTION! If the internal pressure of a vacuum gauge device is allowed to increase above local uncorrected barometric pressure (atmospheric pressure side), vacuum fittings may release and possible overpressure conditions may cause leaks that would allow the gas inside the gauge tube to release into the atmosphere of the surrounding environment. Toxic, pyrophoric and flammable gases are examples of hazardous gases that if allowed to leak out of the vacuum/pressure containment vessel into the atmospheric environment, could cause bodily injury and possible damage to equipment. Never expose the gauge tube internal volume to pressure above local atmospheric pressure when using hazardous gases.

3.5 Gases other than Nitrogen / air

 **WARNING!** Do not attempt to use with gases other than nitrogen (N₂) or air without referring to correction factor data tables.

INFICON gauges and modules are calibrated for direct readout of nitrogen or air. Do not attempt to use with other gases such as argon (Ar) or carbon dioxide (CO₂) unless you have applied correction factors to both the displayed pressure and the analog output to determine the true measured pressure. This is particularly critical when using convection gauges to measure pressure of gases other than N₂/Air.

 **WARNING!** Do not use the IG in an explosive atmosphere or in the presence of flammable gases, vapors or fumes. Do not use the IG to measure the pressure of explosive or combustible gases or gas mixtures. The sensor filaments operate at incandescent temperatures and could become an ignition source. This could cause an explosion which could result in serious injury or death.

 **WARNING!** Do not use the PGE050 in an explosive atmosphere or in the presence of flammable gases, vapors or fumes. Do not use the PGE050 to measure the pressure of explosive or combustible gases or gas mixtures. The sensor wire in the gauge normally operates at 125 °C, but if malfunction should occur, the wire temperature could exceed the ignition temperature of certain combustible gases and gas mixture. This could cause an explosion which could result in serious injury or death.

4 Installation

4.1 Mechanical Installation - Controller

The unit is intended for indoor use only. The unit is offered as a space saving half rack design. It may also be used as a bench top device or easily installed in an instrument panel. Optional EIA-standard rack mount panels are available for either full rack or dual, side-by-side rack mount installation. When mounting multiple units in your rack mount enclosure or mounting the unit below other electronic equipment in your rack, allow at least 1U of space (1.75 in., 45 mm) between the units to ensure adequate ventilation.

4.1.1 Panel Mount

Procedure

- 1 Make a cutout in your rack panel or instrument control panel as shown in the drawing below. Be sure to allow clearance behind the panel for the instrument as well as connectors and cables at the back of the instrument. Optional EIA-standard, 19-inch, 2U height rack mount panels are available from INFICON. The optional rack mount panels are provided with panel cut-outs and mounting holes to allow efficient mounting of your VGC083 unit.

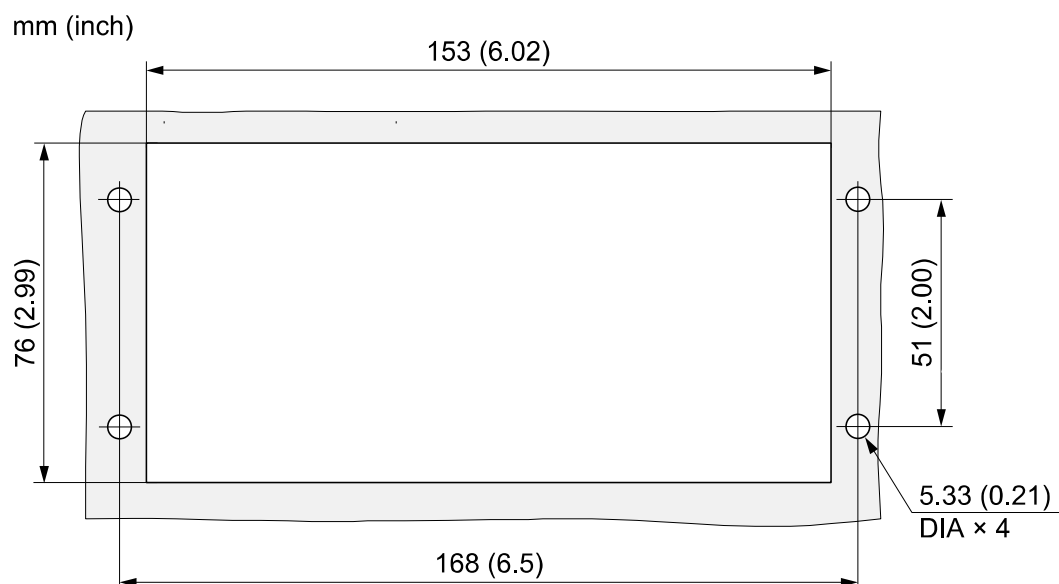

- 2 Drill four guide holes on each side of the panel cut out (two on each side) with dimensions as shown in the panel cut-out drawing above.
- 3 Slide the unit into the panel hole cut-out. Guide the four studs on the back of the unit front panel face plate thru the four holes next to the panel cut-out.
- 4 Use four # 10-32 Hex Nut (provided with instrument) to tighten the unit to the panel.

4.1.2 Rack Mount

Optional EIA-standard 19-inch wide, 2U height rack mount panels available from INFICON (→ 85):

Single cut-out panel

All dimensions in inches.

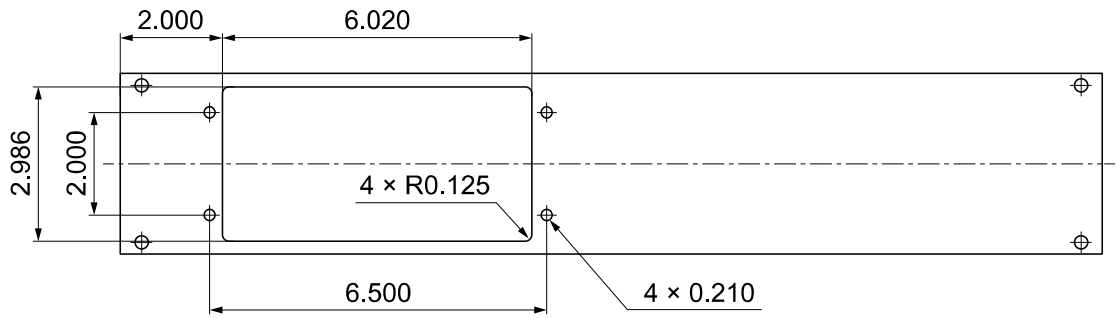

Single cut-out panel

All dimensions in inches.

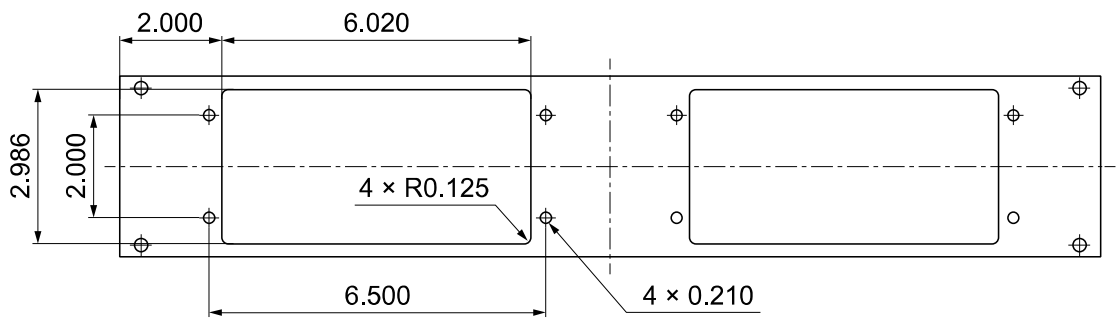

The single cut-out and dual cut-out rack mountable panels shown above are available from INFICON. Panel color matches the front panel of VGC083 units. Screws for mounting to rack enclosure are included.

4.1.3 Mechanical Installation - Ionization Gauge

VGC083A



The VGC083A can operate one INFICON BAG050 nude UHV EB-degas Bayard-Alpert hot cathode ionization gauge or other brands of equivalent nude UHV EB-degas B-A gauges or or INFICON BAG055 Mini IG.

VGC083B

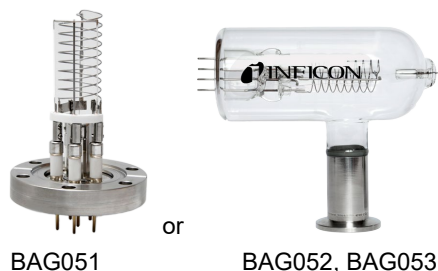

The VGC083B can operate one INFICON BAG051 nude or one BAG052/053 glass enclosed I²R Bayard-Alpert hot cathode ionization gauge or other brands of equivalent gauges.

Mount the ionization gauge as close as possible to the pressure you want to measure. Long or restricted, small diameter tubing will create a pressure difference between your process chamber and the gauge. This may cause a delay in response to pressure changes. Mounting the ionization gauge too close to a gas source inlet may also cause measurement and control instability.

The ionization gauge can be mounted in any orientation, however, if possible, mount the gauge with port down to help minimize the effect of any particles or condensation collecting in the gauge.

Do not mount the ionization gauge where it will be subjected to excessive vibration. Vibrations may cause unstable readings, measurement errors and possible mechanical stress to components in the ionization gauge.

Shield the ionization gauge near ion or electron sources such as an electron beam or in a sputtering system.

For electrical safety purposes the housing of the gauge must be grounded to the vacuum chamber. When using KF flanges, metal clamps must be used to ensure proper grounding. Do not attempt to modify your flange in order to use non-metallic-type flange clamps.

Fittings/Flanges - follow the fitting/flange manufacturer's recommendations for installation and use.

Use all metal vacuum fittings with metal seals when operating pressures are expected to be below 1.00×10^{-7} Torr (1.33×10^{-7} mbar, 1.33×10^{-5} Pa).

4.1.4 Mechanical Installation - Convection Gauge

NOTICE

For more detailed information about the PGE050 convection gauge, please refer to the Operating Manual for the PGE050.

Mount the PGE050 as close as possible to the pressure you want to measure. Long or restricted, small diameter tubing will create a pressure difference between your process chamber and the gauge. This may cause a delay in response to pressure changes.

Mounting the PGE050 too close to a gas source inlet may also cause measurement and control instability. Do not mount the PGE050 near a source of heating or cooling, such as heaters or air conditioning vents.

Mount the PGE050 with its main axis horizontal (see diagram below). Pressure reading errors may occur above 1 Torr if the unit is not mounted horizontally. Below 1 Torr, mounting position has little to no effect.

For Accurate Measurements Above 1 Torr, Mount the Gauge Axis Horizontally as Shown Below

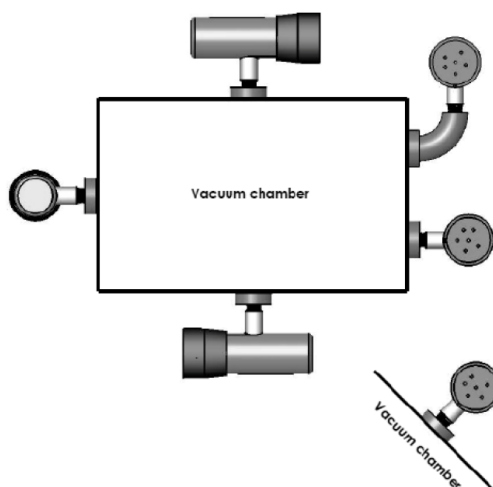

Correct Orientation

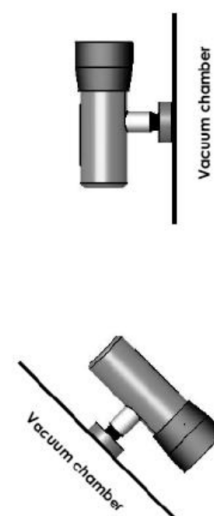

Incorrect Orientation

Mount the PGE050 with port down, if possible, to help minimize the effect of any particles or condensation from collecting in the gauge.

Do not mount the PGE050 where it will be subjected to excessive vibration. Vibrations may cause unstable readings, measurement errors and possible mechanical stress to components in the PGE050.

Flanges/ Fittings - follow the manufacturer's recommendations and note the following:

- NPT fittings: When connecting the device using a NPT fitting, apply a thread sealant compound or wrap the threaded portion of the tubing with one-and-a-half to two wraps of pipe thread seal tape such as PTFE (Teflon[®]) tape and hand tighten the gauge into the gauge port. Do not use a wrench or other tool which may damage the gauge.

4.2 Electrical Installation

4.2.1 Grounding

 Be sure the vacuum gauges and the rest of your vacuum system are properly grounded to protect personnel from shock and injury. Be aware that some vacuum fittings, especially those with O-rings when not used with metal clamps, may not produce a good electrical connection between the gauge and the chamber it is connected to. Use a ground lug on the vacuum connection flange of the pressure measurement device if necessary. The VGC083 control unit should be connected to earth ground via a good quality equipment earthing conductor. It is encouraged that you connect a separate 12-AWG earthing conductor between a known facility earth ground connection and the location marked with the earth ground symbol (via the green colored screw provided) on the back panel of the VGC083.

4.2.2 Installation

A good, recommended practice is to remove power from any cable prior to connecting or disconnecting it. The electrical connections for the VGC083 are located on the back panel of the device as shown below.

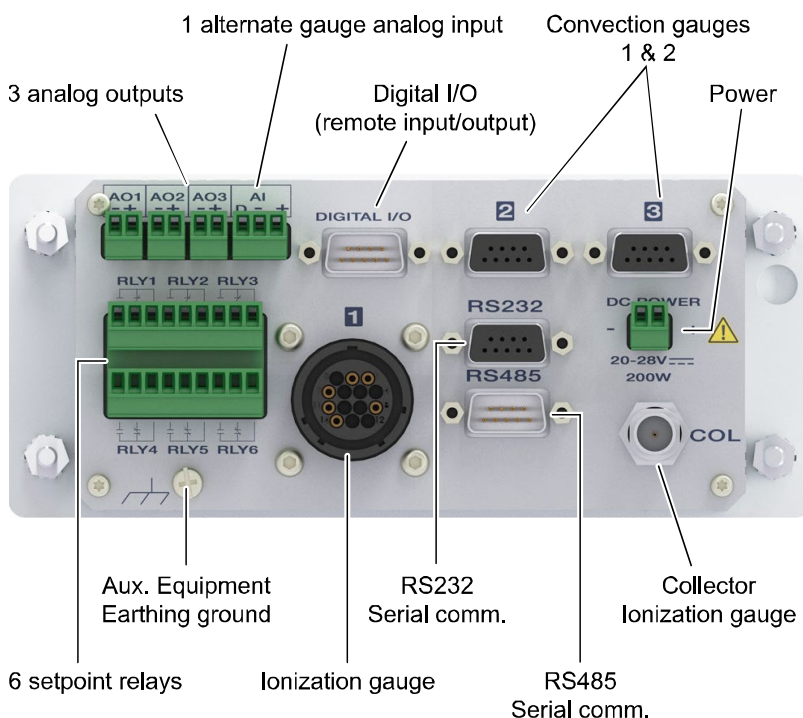

4.2.3 Connecting the Ionization Gauge Cable

Good, recommended practice is to remove power from any cable prior to connecting or disconnecting it. With INFICONs nude B-A ionization gauge head (or other brands of equivalent gauges) or the BAG055 Mini IG connected to your vacuum chamber, connect an appropriate length of ion gauge cable (see various IG cable configurations shown below) from the ion gauge head on the vacuum chamber to the back panel connector of the VGC083 labeled "1". The circular plastic connector (CPC) is keyed to allow easy orientation of the mating connectors. The BNC connector is for connecting the low-level ion current signal from the ion collector electrode of the head. The coaxial cable with the BNC connector at the controller end of your cable is connected at the BNC connector labeled "COL".

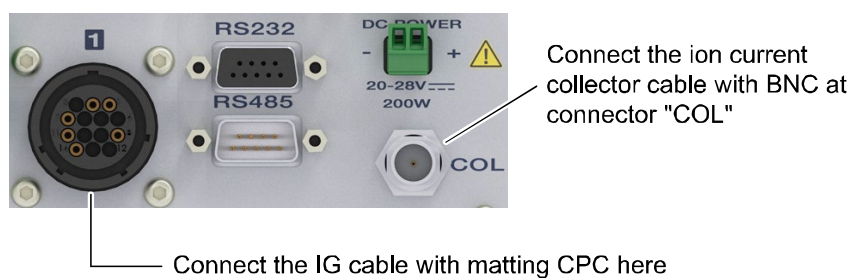

CAUTION! When changing or making cabling connections to any device controlled by the VGC083, you must first turn power to the VGC083 **OFF**. Failure to disconnect power to the VGC083 before either changing cable connections from options to devices or removing/installing option cards in the VGC083 may result in equipment damage or possible injury to personnel.

VGC083A: BAG050, BAG055
Cable

Part numbers → 85.

BAG050 nude IG
bakable cable 200 °C

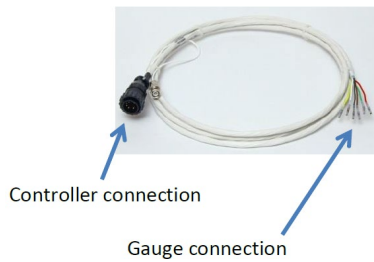

BAG050 nude IG
50 °C



BAG055 Mini IG cable
50 °C

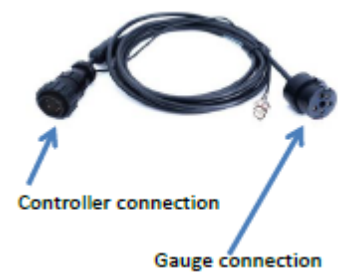

VGC083B: BAG051,
BAG052, BAG053 cable

Part numbers → 85.

BAG051 nude IG
bakable cable 200 °C

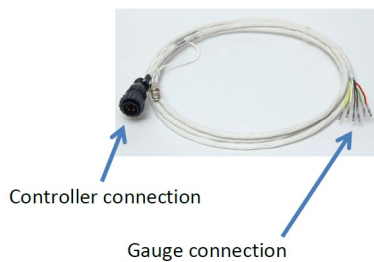

BAG051 nude IG cable
50 °C



BAG052 / 053 glass IG cable
50 °C



NOTE

IG Cables not manufactured by INFICON may differ in design. Cables from certain manufacturers may be specifically constructed for the type of DEGAS used in various versions of the B-A ionization gauge head. Contact reachus@inficon.com if you have any questions regarding the connections to be made to ionization gauge heads using IG cables not manufactured by INFICON.

4.2.3.1 Standard Nude, Glass and Mini IG Cables

VGC083A

For the nude or Mini IG, connect the IG cable (PN → 85) at the VGC083A controller as described in the previous page. After installing the nude IG head on your vacuum system, connect the head end of the IG cable as shown below.



BAG050 nude IG head cable
connection



BAG055 Mini IG head cable
connection

VGC083B

For the glass IG, connect the IG cable (PN → 85) at the VGC083B controller as described in the previous page. After installing the glass IG head on your vacuum system, connect the head end of the IG cable as shown below.



BAG052 / 053 glass IG head cable connection

For the nude IG, connect the IG cable (PN → 85) at the VGC083B controller as described in the previous page for VGC083A. After installing the nude IG head on your vacuum system, connect the head end of the IG cable as shown below.



BAG051 nude IG head cable connection

4.2.3.2 Bakeable Nude IG Cable

VGC083A: BAG050 only

Do not use with BAG055 Mini IG

The bakeable nude IG cable (PN → 85) is provided with push-on sockets for connection to the nude gauge pins (BAG050 pins) and is bakeable to 200 °C (See Bakeable Cable wiring information below). All other cables listed above are rated for 50 °C ambient temperature. All IG cables provided by INFICON can be used with either single or dual filament ion gauges and filament switching is controlled from the VGC083A controller.

When using the bakeable IG cable (PN → 85) connect the VGC083A to BAG050 or equivalent Nude EB- degas IG head according to wire colors listed below.

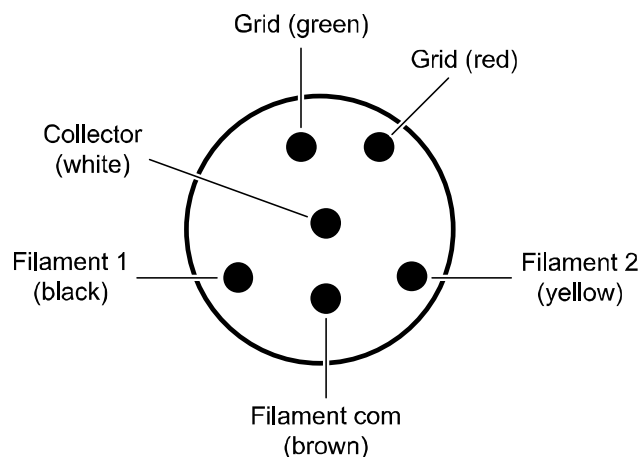

BAG050 nude UHV EB-degas IG or equivalent B-A gauge pin pattern

Changing cables from one device to another when power is applied to the controller is not only bad electronics handling procedure, it is not advised and, if done by the user of this equipment, may lead to erroneous measurement results, a hazardous situation, equipment damage and possible operator injury.

⚠ CAUTION! It is always good industry practice to turn off power to the instrument before connecting or disconnecting cables.

VGC083B: BAG051 only

Do not use with BAG055 Mini IG

The bakeable nude IG cable (PN → 85) is provided with push-on sockets for connection to the nude gauge pins (BAG051 pins) and is bakeable to 200 °C (See Bakeable Cable wiring information below). All other cables listed above are rated for 50 °C ambient temperature. All IG cables provided by INFICON can be used with either single or dual filament ion gauges and filament switching is controlled from the VGC083B controller.

When using the bakeable IG cable connect to BAG051 or equivalent nude I²R B-A Gauge according to wire colors listed below.

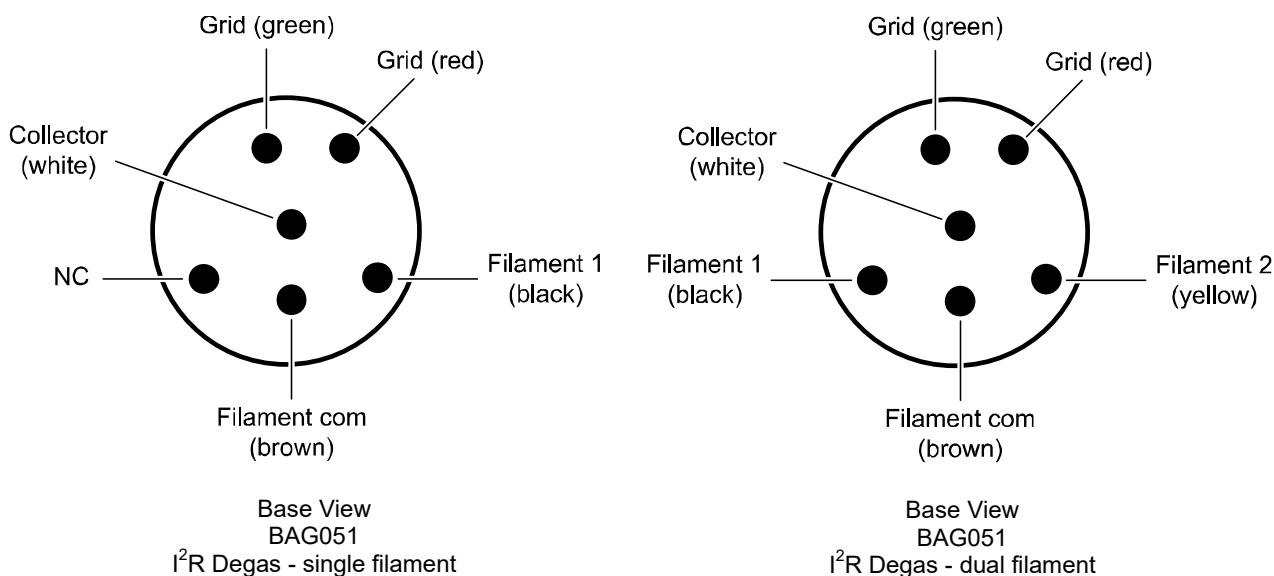

BAG051 or equivalent nude I²R (resistive degas) B-A gauge pin pattern

Changing cables from one device to another when power is applied to the instrument is not only bad electronics handling procedure, it is not advised and, if done by the user of this equipment, may lead to erroneous measurement results, a hazardous situation, equipment damage and possible operator injury.

⚠ CAUTION! It is always good industry practice to turn off power to the instrument before connecting or disconnecting cables.

4.2.3.3 Standard nude IG Cable Connector Pin Out

The information presented in this section is intended to address the installation / connection of a nude B-A type ionization gauge head or an IG cable that you may already have installed on your vacuum vessel which may not be directly compatible with INFICON product designs, and you wish to continue using either that head / cable with the VGC083.

The pin-out of the CPC connector used on Granville-Phillips® and INFICON Ion Gauge cables is shown below. When using INFICON two-filament switch capable cables such as those for use with controllers capable of switching the filament from the control unit, e.g., the VGC083, there is an additional pin / socket connection at contact no. 7 for FIL2. This type of cable and control unit will allow the user to switch filaments from the control unit - there is no need to go to the head end of the cable and physically remove, rotate and reconnect the cable connector when it is desired to switch filaments.

The view shown below is the CPC connector end of the IG cable:

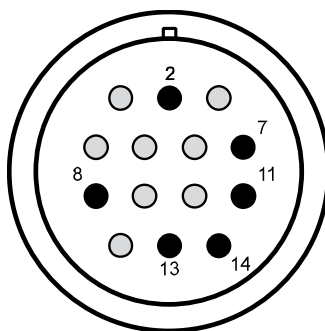

VGC083 Connector End of Cable View

Pin/Socket Contact Number	Description (compatible with Granville-Phillips® ion gauge cables)
2	Shield, chassis ground
7	FIL 2 (this contact is only present on dual filament IG cables available from INFICON)
8	FIL COM
11	FIL 1
13	Grid Source (supply)
14	Grid return Used only for I ² R degas design using the VGC083B Not used for VGC083A EB-degas design

4.2.4 Connecting the PGE050 - connectors labeled "2" and "3"

PN 399-580 ... -582 are a custom cable assemblies provided in different lengths from INFICON for connecting the VGC083 to INFICON PGE050 gauge or MKS Instruments / Granville-Phillips® 275 Convectron® vacuum gauge sensor. Connect the DE-9 D-subminiature connector to VGC083 and PGE050 connectors to "2" or "3".

For your reference, the wiring chart for the PGE050 cable provided by INFICON is shown below. In addition to INFICON provided standard cable assembly lengths, INFICON will provide custom length cable assemblies upon request.

VGC083 pin no.	connects to	PGE050 gauge pin no. (INFICON molded, custom connector)
1	⇒	NC
2	⇒	cable shield
3	⇒	3
4	⇒	3
5	⇒	2
6	⇒	5
7	⇒	1
8	⇒	1
9	⇒	NC

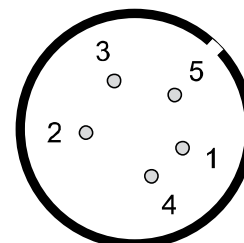

4.2.5 Power Connection

The VGC083 requires an input power of 20 ... 28 V (dc), 200 W to operate. One each 2-contact pluggable terminal strip mating connector is provided for connection to the power contactors. Optional power supplies are also available from INFICON (PN → 85).

Power (contacts)	Contact Description	Power Input Connector
+	Power input (20 ... 28 V (dc), 200 W)	
-	Power ground	

4.2.6 Relay Connection

A total of six setpoint relays are provided by the VGC083. Two each 9-contact pluggable terminal strip mating connectors are provided for easy connection to the relay contactors. The VGC083 back panel relay connectors are marked RLY1 thru RLY6. Each relay has a contact labeled = (Normally Open), ≠ (Normally Closed) and I (common).

RLY1 thru RLY6 (contacts)	Contact Description	Relay Connectors
=	Relay #1 to Relay #6 (NORMALY OPEN)	
≠	Relay #1 to Relay #6 (NORMALY CLOSED)	
I	Relay #1 to Relay #6 (COMMON)	

4.2.7 Analog Output Connection

A total of three analog outputs are provided by the VGC083. These output voltage signals are proportional to the displayed pressure for any of the user assigned vacuum gauges. Three each 2-contact pluggable terminal strip mating connectors are provided for connection to the analog output contactors. The VGC083 back panel analog output connectors are marked AO1, AO2 and AO3. Each connector has a contact labeled + (analog output signal) and - (analog output ground).

AO1 , AO2, AO3 (contacts)	Contact Description	Analog Output Connectors
+	Analog Output #1 to #3 (Signal)	
-	Analog Output Ground #1 to #3 (Signal Return)	

4.2.8 Analog Input Connection (Capacitance Diaphragm Gauges, etc.)

One analog input is provided by the VGC083 for using as an alternate gauge to "2". This input can be accepted from one capacitance diaphragm gauge or other INFICON vacuum module series PGE300, PGE500 or BAG302. One each 3-contact mating pluggable terminal strip connector is provided for connection to the analog input connector. The VGC083 back panel analog input connector is marked A1. Each connector has a contact labeled + (analog input signal) and - (analog input ground) and D (power detect).

A1 (contacts)	Contact Description	Analog Input Connector
+	Analog Input (Signal)	
-	Analog Input Ground (Signal Return)	
D	Detect (power detect)	

When using a capacitance manometer / diaphragm gauge or INFICON modules such as the PGE300, PGE500, BAG302 as an ALTERNATE GAUGE, the gauge must be connected to the VGC083 as shown below. The alternate gauge must be provided power from an auxiliary power supply capable of providing the power required by the alternate gauge connected to the VGC083. The D contact is used in this configuration to protect the IG from being turned on at high pressure in case power to the alternate gauge is lost.

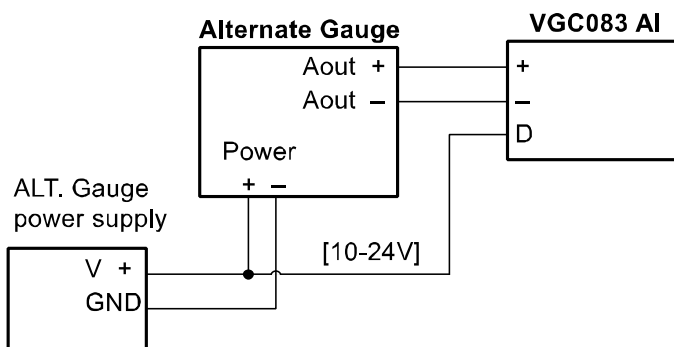

An Auxiliary Power Supply is required for your Alternate Gauge, e.g., a CDG. Ensure power is applied to your Alternate Gauge before turning on the power to VGC083.

4.2.9 Digital I/O Connection

The IG can be controlled manually using the front panel soft-keys, via remote input signals using the digital I/O connector or RS232/RS485 commands. The VCG083 can also be configured so that the IG sensor on/off is controlled by using the pressure measurements from CG1, CG2 or the alternate gauge. If the user prefers digital I/O as the means of controlling the IG, various control input and status output signals are available from the 9-pin D-sub male DIGITAL I/O connector. The DIGITAL I/O Connector also provides pin-pin compatible signals with the GP 358 vacuum gauge controller as well as compatible signals with the GP 307.

The DIGITAL I/O Connector provides three different types of signals as listed below:

Signal Type A - Control Input Signals

The IG sensor on/off, degas on/off and emission current selection can be set by applying momentary continuity to ground. This requires a momentary ground of less than 0.4 V (dc) at 10 μ A for 25 msec (minimum) be applied. After this, the input must be allowed to float higher than 3.5 V (dc) for 105 msec (minimum) before another low can be applied.

Input signal: Apply momentary continuity to ground to turn IG sensor on or off
 Apply momentary continuity to ground to turn degas on or off
 Apply momentary continuity to ground to switch Emission Currents (100 μ A or 4 mA)

Signal Type B - Status Output Signal

The IG on/off status relay is also available as both normally open and normally closed to indicate IG is on or off. This is an output signal to other external instruments to confirm IG filament is on or off. The IG on / off status relay is a single pole, double-throw (SPDT) relay rated at 1.0 A, 30 V (dc) resistive or 1.0 A, 30 V (ac) non-inductive.

Signal Type C - Status output Signal

A degas status or an error condition output signal is also available from the DIGITAL I/O Connector. If programmed for DEGAS STATUS, this can be used as an output signal to other external instruments to confirm that degas is on or off. If programmed for an error condition, this can be used as an output signal to other external instruments to confirm whether any error conditions exist.

Signal: Open collector transistor (ground emitter) rated at 40 V max. VCE, 50 mA IC max.

Transistor on = Degas on or error condition exists,
 Transistor off = Degas off or no error condition exists

9-pin (DE-9P) D-subminiature DIGITAL I/O Connections

Pin no.	Description	Signal Type	Digital I/O Connector
1	IG Sensor on/off	A	
2	Ground		
3	Emission Current	A	
4	IG on/off Status relay common	B	
5	IG on/off status relay - Normally Closed Relay open = IG on	B	
6	Degas on/off	A	
7	Ground		
8	Degas/error status, Low = degas on or error	C	
9	IG on/off status relay - Normally open Relay closed = IG on	B	

4.2.10 RS232 / RS485 Serial Communications Connection

Either RS232 or RS485 serial communications may be used to send/receive commands to/from the VGC083. There are two DE9 (D-subminiature, shell size E, 9 pole) connectors that allow independent cable connections to the RS232 and RS485 serial communication ports. Six serial communication protocols are supported.

1. RS485 with address, start and stop characters and command/response syntax derived from the INFICON BAG302 IG protocol.
2. RS232 with start and stop characters, but no addressing is used. The syntax is the same as the RS485 protocol.
3. RS232 protocol compatible with the Granville-Phillips Series 307 and 358 controllers.
4. RS485 protocol compatible with the Granville-Phillips Series 307 and 358 controllers.
5. RS232 protocol compatible with the Granville-Phillips Series 350 controller.
6. RS485 protocol compatible with the Granville-Phillips Series 350 controller.

The RS232 serial port is configured to allow, for example, a 9-pin extension cable, male to female, wired "pin-to-pin" to be connected from the VGC083 to your serial port. DO NOT connect both of the RS232 and RS485 cables to the VGC083 at the same time. The VGC083 cannot provide both RS232 and RS485 serial communications at the same time. Only one or the other as programmed by the user.



An extension cable wired pin-to-pin may be used to connect the RS232 serial port on the VGC083 directly to your PC serial port (a converter may be necessary).



DE-9 Connectors for connections to user supplied cables for serial communication port – DE9P (RS485), DE9S (RS232)

9-contact (DE-9S) D-subminiature RS232 Connections

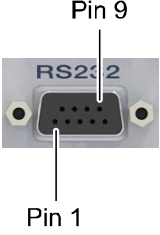
Socket no.	Description	RS232 Connector
1	No connection	
2	Transmitted Data (OUT)	
3	Received Data (IN)	
4	No connection	
5	Signal Ground	
6	No connection	
7	No connection	
8	No connection	
9	No connection	

Connect either RS232 or RS485 cable to VGC083 - DO NOT CONNECT BOTH AT THE SAME TIME

9-pin (DE-9P) D-subminiature RS485 Connections

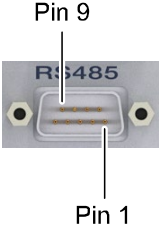
Pin no.	Description	RS485 Connector
1	DATA A (-)	
2	DATA B (+)	
3	No connection	
4	No connection	
5	No connection	
6	Signal Ground	
7	No connection	
8	No connection	
9	No connection	

Connect either RS232 or RS485 cable to VGC083 - DO NOT CONNECT BOTH AT THE SAME TIME

5 Operation - IG and CG

5.1 IG Emission Current

When used with BAG050 / 051 / 052 / 053 nude/glass IG 100 μ A (0.1 mA), 4 mA, and 10 mA are available settings of emission current for the hot cathode ion gauge.

When used with BAG055 Mini IG 100 μ A (0.1 mA) and 4 mA are available settings of emission current for the hot cathode ion gauge.

- 1) In clean applications and when operating at higher pressure ranges (5.00×10^{-6} Torr to 1.00×10^{-3} Torr) the 100 μ A emission setting is preferred.
- 2) At lower operating pressures (1.00×10^{-9} Torr to 5.00×10^{-4} Torr) the 4 mA emission setting should be used.
- 3) When using the nude or glass IG many vacuum measurement equipment users prefer to use the 10 mA emission current setting when making measurements in the UHV pressure regime (below 1.00×10^{-8} to 10^{-11} Torr).
- 4) When using a diffusion pump or other pumps that use fluids, there is a possibility of the pump oil vapors entering the IG head. These vapors may form an insulator on the internal components of the head which can lead to instability or failure in controlling the emission. In this case, 4 mA and 10 mA emission current may provide improved operating lifetime and measurement performance.
- 5) The emission current can also be set to automatically switch between 100 μ A, 4 mA and 10 mA. This results in optimal and stable pressure readings over the entire measurement range from low to high vacuum. For example, if an application requires that pressure measurements be performed by the ion gauge from pressures lower than
 VGC083A: 5.00×10^{-6} Torr up to 1.00×10^{-3} Torr
 VGC083B: 1.00×10^{-6} Torr up to 1.00×10^{-3} Torr,
 then the user may want to consider selecting the auto switching feature of the emission current.

5.2 IG Degas

Electron bombardment degas (VC083A) or I^2R resistive degas (VGC083B) is used to rid a hot cathode ion gauge sensor of adsorbed gas. The intervals at which degas should be applied vary for each application. The low pressure measurement performance of the head will normally improve after each degassing cycle.

- Degas can only be applied while the filament is turned on and operating.
- Ensure that the vacuum pressure is at or less than 5.00×10^{-5} Torr before attempting to initiate degas.
- Degas will automatically turn off after 10 minutes when using factory default settings. Degas can be programmed for duration of 2 to 30 minutes.
- The VGC083 will continue to measure approximate pressure while degas is in progress.
- Degas will automatically turn off if the pressure exceeds 1.00×10^{-4} Torr during the degas cycle when using the BAG050 / 051 / 052 / 053 IG, or 4.00×10^{-3} when using the BAG055 Mini IG but the filament will remain turned on.
- Degas can be interrupted by turning the IG filament off.

5.3 IG Filament Material Selection / Venting the Chamber

The choice of which filament to use is primarily dependent upon the process and process gases the ion gauge will be used with. For general vacuum applications, dual yttria coated filaments are offered for use with air and inert gases such as N_2 , argon, etc. Optional dual tungsten filaments are available for use with gases that are not compatible with yttria coated iridium filaments.

Yttria coated iridium filament

In most general vacuum applications, the yttria coated iridium filament is the best choice.

Yttria coated iridium filaments typically operate at a lower temperature than tungsten filaments and thus have a lower outgassing rate at UHV and lower chemical reactivity with active gases. Yttria coated iridium filaments typically have a longer operating life than tungsten filaments in clean applications.

The yttria coated filament can survive occasional accidental start attempts at atmosphere in air, but the overall life of the filament may be shortened during each occurrence. Good vacuum practice is to use a separate pressure gauge such as INFICON's PGE050 convection gauge to know when to turn on the ion gauge filament.

Tungsten filament

Typically, a bare tungsten filament is a better choice in those applications where an yttria coated filament is quickly damaged due to the gas type in use. For example, processes such as ion implantation may only use tungsten filaments. Be aware that corrosive applications are hard on any filament and filament life will be shortened while operating in such environments. Tungsten filaments are easily damaged by exposure to air/oxygen during accidental system vents or if considerable quantities of water vapor are outgassed during pump-down and bake-out. It is very important to make sure the tungsten filament is turned off before bringing the chamber up to atmosphere, especially if air is being used to vent the chamber. The use of pure N₂ gas is highly recommended to vent or purge your vacuum chamber. Testing has shown that tungsten filaments can withstand limited high pressure excursions when only N₂ is present.

Venting with air or other gases containing oxygen can damage the tungsten filaments. If you try to turn on an ion gauge with tungsten filaments while it is sitting on your desk exposed to room air, you will immediately damage or destroy the filament beyond repair.

NOTICE

Do not use another gauge to automatically turn off the ion gauge when the ion gauge (IG) filament in use is constructed of tungsten (yttria coated filament is ok). The response time of other gauges may not allow for timely turn off of the tungsten filament leading to filament damage. Always turn off the IG filament manually before pressure is allowed to rise above 1.00×10^{-3} Torr.

NOTE

Both types of filaments will suffer eventual damage if operated at high pressures. The type and amount of damage at high pressure is dependent upon the length of operating time, the pressure and the gas present.

5.4 IG Over Pressure Shut Down

The VGC083 is provided with factory set default values for over pressure shut down. The IG will shut off automatically should the pressure reach or rise above the pressure shut down values shown below:

Factory set IG overpressure shut down values for BAG050 / 051 / 052 / 053

Emission Current	Overpressure Shut Down		
	Torr	mbar	Pa
100 μ A (0.1 mA)	1.00×10^{-3}	1.33×10^{-3}	1.33×10^{-1}
4 mA	5.00×10^{-4}	6.65×10^{-4}	6.65×10^{-2}
10 mA	1.00×10^{-4}	1.33×10^{-4}	1.33×10^{-2}

Factory set IG overpressure shut down values for BAG055 Mini IG

Emission Current	Overpressure Shut Down		
	Torr	mbar	Pa
100 μ A (0.1 mA)	5.00×10^{-2}	6.65×10^{-2}	6.65
4 mA	1.00×10^{-3}	1.33×10^{-3}	1.33×10^{-1}

5.5 IG Over Temperature Shut Down

An over temperature condition may result inside the VGC083 controller when using an ion gauge cable longer than 50 ft. When this over temperature condition exits and if degas is on, the controller will automatically turn off degas first. If the temperature inside the controller continues to climb, the controller will then turn off the IG filament and an "OVER TEMP" message will appear on the programming & setup screen. When this extreme condition exists, the VGC083 may need airflow around it to prevent the over temperature shut down.

5.6 Convection Gauge (CG) Initial Setup

Two of the most important steps for the initial setup of the convection gauges are to set zero (SET VAC) and set atmosphere (SET ATM) as described in the CONVEC GAUGE section 6.5.3. This will ensure proper operation of the gauge and accurate pressure measurements. The gauge is calibrated at the factory using nitrogen. Furthermore, the gauge is also installed in a certain orientation when calibrated at the factory. Without setting zero and atmosphere after the gauge is installed in your system, the gauge may not display the expected and correct pressures. This could be caused by the fact that you may be using a different gas than Nitrogen such as air to setup and calibrate the gauge (most commonly the case) and the gauge orientation is different than the orientation used at the factory. As such, it is very important to perform your own initial setup and calibration by setting zero and atmosphere with the gauge installed in your actual system. Please note the following:

Setting Zero (SET VAC)

Setting zero optimizes performance of the gauge when operating at a low pressure range of 1.00×10^{-4} Torr to 1.00×10^{-3} Torr. If your minimum operating pressure is higher than 1.00×10^{-3} Torr, it is not normally necessary to set zero and thus setting atmosphere should be adequate. If you are able to evacuate your system to below 1.00×10^{-4} Torr, it is always a good practice to check and set zero if necessary. See "SET VAC CG1" or SET "VAC CG2" in CONVEC GAUGE section 6.5.3.

Setting Atmosphere (SET ATM)

Setting atmosphere is the most important step for a newly installed gauge. If you prefer to use air to set atmosphere, vent your vacuum system chamber to expose the gauge to the local atmospheric pressure (air) and set atmosphere to match your known local uncorrected barometric pressure (air). This is the reading of ambient air pressure you will expect if you were to vent and open your vacuum chamber to the atmosphere surrounding the outside of your chamber. At sea level, this pressure is usually near 760 Torr. At elevations above sea level, the pressure decreases. Check your local aviation authority or airport web sites or your current local weather conditions online to help find your local uncorrected barometric pressure if you do not have this information. See "SET ATM CG1" or "SET ATM CG2" CONVEC GAUGE section 6.5.3.

NOTE

Setting zero and atmosphere is normally required only once during the initial setup and maybe checked by the user periodically. After power has been applied to the gauge during the initial setup, allow five minutes for the gauge to stabilize (warm-up) before setting zero and atmosphere.

The information presented in sections 5.1 through 5.6, above, is intended as an introduction to the programming capabilities of the VGC083 for use in controlling the selectable parameters and functions of the BAG050 IG (VGC083A), BAG051, BAG052/053 IG (VGC083B) and PGE050 heads.

6 Setup and programming

6.1 Applying Power

Before you turn on power to the VGC083 for the first time, ensure the cables from the VGC083 to the BAG05x nude on Mini and PGE050 convection gauges are connected and secured. Turn on power by pressing the Power key.

6.2 Front Panel Display

Display - Pressure Measurement

The VGC083 provides three independent front panel LED displays:

- **1** display represents pressure measurements from the BAG05x hot ion gauge head (IG).
- **2** display represents pressure measurements from the first convection gauge (CG1).
- **3** display represents pressure measurements from the second convection or an alternate gauge (CG2 or CG2-ALT).

Display - Units of Measure

A white LED is illuminated next to the selected engineering unit indicating measurements in Torr, mbar or Pa (the pascals unit of measure is indicated as 'Pa' on the front panel; millibars unit is indicated as mbar).

Display - Setup Screen

The VGC083 provides an independent setup and programming OLED setup screen. This screen is used for set up, programming and operation of the ion and convection vacuum gauges. Other useful information such as relay status indicators, emission current and selected IG filament are also displayed in the setup screen.

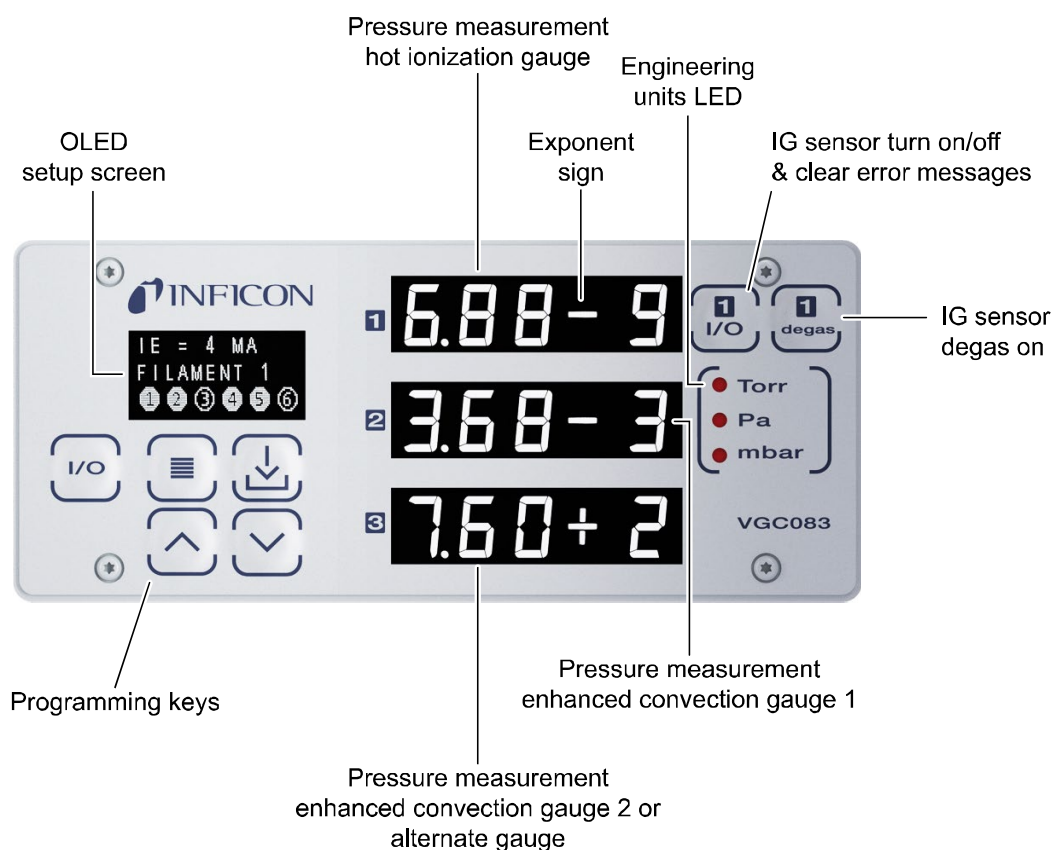

6.3 User Interface Basics

The setup and programming of the VGC083 controller is done via the four programming-keys located below the OLED setup screen on the left hand side of the VGC083 front panel. During programming of the VGC083, the OLED display will identify what function each key represents.

To begin programming, press the MENU key. Press the UP and DOWN key to select the desired menu and change the parameters. Press the ENTER key to access the parameters and save the new settings. Press the MENU Key to return to the previous menu or press repeatedly to return to the main screen. To continue setting additional parameters, scroll with the UP and DOWN keys until you reach the desired parameter then press ENTER.

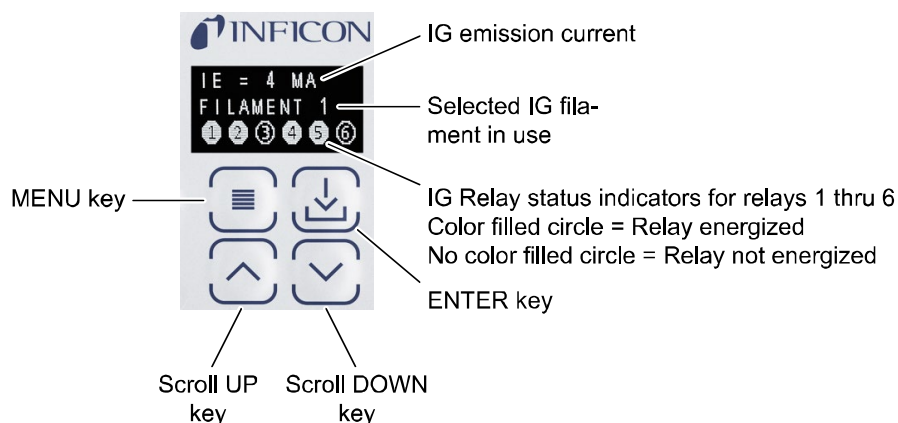

NOTE The value of certain menu parameters must be programmed within an allowable range or limit. If the user tries to program a value that is outside of the allowable range of a specific menu, the setup screen will momentarily display the message "NO CHANGE". In this case, the user needs to access the specific menu again, and enter a correct value that is within the allowable range.

6.4 Factory-Set Default Parameters

The following is a summary of all factory-set default values in the VGC083 setup screen menu.

SETUP UNIT

- UNITS [Factory default = TORR]
- INFO [Factory default = FIRMWARE VERSION]
- SET CG2-ALT [Factory default = CG2]
- ALT GAUGE [Factory default = 10 TORR CDG]
- ALT GAUGE CAL [Factory default = Factory Set Number]
- I - O STATUS [Factory default =DEGAS STATUS]
- DEFAULTS [Factory default = PRESS ENTER TO SET OR MENU TO EXIT (not useable if IG sensor is on)]

ION GAUGE

When used with BAG050 /
051 / 052 / 053

- EMISS SELECT [Factory default = IE = 100UA]
- AUTO IE1 TRIP [Factory default = DISABLED]
- AUTO IE2 TRIP [Factory default = DISABLED]
- SELECT FIL [Factory default = FILAMENT 1]
- DEGAS TIME [Factory default = 10 MINUTES]
- SENSITIVITY [Factory default = 25.00]
- OVER PRES 100 [Factory default = 1.00E-03]
- IG TRIP PRES [Factory default = 1.00E-03]
- IG CONTROL [Factory default = MANUAL MODE]
- CAL FACTORS [Factory default = C0, C1, C2, C3, C4, C5 all factory-set to 50]
(VGC083A - future use only)

ION GAUGE

When used with BAG055

- EMISS SELECT [Factory default = IE = 100UA]
- AUTO IE TRIP [Factory default = DISABLED]
- SELECT FIL [Factory default = FILAMENT 1]
- DEGAS TIME [Factory default = 2 MINUTES]
- SENSITIVITY [Factory default = 10.00]
- OVER PRES 100 [Factory default = 5.00E-02]
- IG TRIP PRES [Factory default = 1.00E-03]
- IG CONTROL [Factory default = MANUAL MODE]

CONVEC GAUGE

- SET VAC CG1 [Factory default = 0.00E 00]
- SET ATM CG1 [Factory default = 7.60E 02 TORR]
- SET VAC CG2 [Factory default = 0.00E 00]
- SET ATM CG2 [Factory default = 7.60E 02 TORR]

RELAYS

- ASSIGN REL 1 [Factory default =ION GAUGE]
- ASSIGN REL 2 [Factory default =CG1]
- ASSIGN REL 3 [Factory default =CG2]
- ASSIGN REL 4 [Factory default =ION GAUGE]
- ASSIGN REL 5 [Factory default =CG1]
- ASSIGN REL 6 [Factory default =CG2]
- REL 1 LO TRIP [Factory default = 1.00E-06]
- REL 1 HI TRIP [Factory default = 2.00E-06]
- REL 2 LO TRIP [Factory default = 1.00E-01]
- REL 2 HI TRIP [Factory default = 2.00E-01]
- REL 3 LO TRIP [Factory default = 1.00E-01]
- REL 3 HI TRIP [Factory default = 2.00E-01]
- REL 4 LO TRIP [Factory default = 1.00E-06]
- REL 4 HI TRIP [Factory default = 2.00E-06]
- REL 5 LO TRIP [Factory default = 1.00E-01]
- REL 5 HI TRIP [Factory default = 2.00E-01]
- REL 6 LO TRIP [Factory default = 1.00E-01]
- REL 6 HI TRIP [Factory default = 2.00E-01]
- TEST RELAYS
- REL 1 LO DELY [Factory default = 0.0 SECONDS]
- REL 1 HI DELY [Factory default = 0.0 SECONDS]
- REL 2 LO DELY [Factory default = 0.0 SECONDS]
- REL 2 HI DELY [Factory default = 0.0 SECONDS]
- REL 3 LO DELY [Factory default = 0.0 SECONDS]
- REL 3 HI DELY [Factory default = 0.0 SECONDS]
- REL 4 LO DELY [Factory default = 0.0 SECONDS]

- REL 4 HI DELY [Factory default = 0.0 SECONDS]
- REL 5 LO DELY [Factory default = 0.0 SECONDS]
- REL 5 HI DELY [Factory default = 0.0 SECONDS]
- REL 6 LO DELY [Factory default = 0.0 SECONDS]
- REL 6 HI DELY [Factory default = 0.0 SECONDS]
- TEST RELAYS

ANALOG OUTPUT

- ANALOG OUT 1 [Factory default = IG - CG1 0.5 - 7V]
- ANALOG OUT 2 [Factory default = CG1 1 - 8 V]
- ANALOG OUT 3 [Factory default = CG2 1 - 8 V]
- AOUT CAL 1 [Factory default = Factory Set Number]
- AOUT CAL 2 [Factory default = Factory Set Number]
- AOUT CAL 3 [Factory default = Factory Set Number]
- AOUT LIN 1 [Factory default = 1.00E 00]
- AOUT LIN 2 [Factory default = 1.00E 00]
- AOUT LIN 3 [Factory default = 1.00E 00]
- LED BRIGHTNESS [Factory default = 8]

SERIAL COMM

- COMM TYPE [Factory default = RS485]
- BAUDRATE [Factory default = 19200 BAUD]
- FRAMING [Factory default = 8 BITS NONE 1]
- ADDRESS [Factory default = 01]

DISPLAY

- SCREEN SETUP [Factory default = NORMAL]
- SCREEN SAVER [Factory default = ON]
- BRIGHTNESS [Factory default = 0]

6.5 Programming

NOTE

The VGC083A/B controller is shipped from the factory with the ION GAUGE menu default parameters for the nude or glass IG. If you are using the BAG055 Mini IG, connect the Mini IG cable at the controller first, turn power on, access the SETUP UNIT Menu and set "DEFAULTS". This is recommended only one time at the initial set-up and it enables the controller realize its operating the BAG055 Mini IG and will set the default ION GAUGE menu parameters for BAG055. Always power off the unit before disconnecting the IG cable and reconnect the IG cable before turning the power on to ensure proper operation.

This section provides detailed information on programming and configuration of various menus and submenus of the device.



This key, on the VGC083 front panel, is referred to as the 'ENTER' key throughout this manual.

From the main menu (press the MENU key if the main menu is not shown), scroll Up or Down to SETUP UNIT then press the ENTER key to access the SETUP UNIT menu for configuring the VGC083 general parameters such as the units of measure, selecting CG2 versus ALTERNATE GAUGE, etc. In certain instances, during setup of the programmed functions and settings, you may need to press the ENTER key until you reach the end of a program/setup sequence before pressing the MENU key to return to the main menu or previous setup screen.

6.5.1 SETUP UNIT

UNITS	<p>[Factory default = TORR]</p> <p>This allows the user to display the pressure measurements in Torr, mbar or pascals. The user must program all other programming values according to their requirements.</p>
INFO	<p>[Factory default = FIRMWARE VERSION]</p> <p>Provides the model number of VGC083, the firmware version numbers for both the VGC083 controller and the IG connected to it.</p>
SET CG2 - ALT	<p>[Factory default = CG2]</p> <p>This allows the user to assign the type of gauge to the CG2/ALT display. The user can either assign a second convection gauge CG2 (same type as CG1 using INFICON's PGE050 convection gauge sensor) or analog input using a 0-10 V (dc) analog input signal from an alternate gauge. The ANALOG INPUT selection allows processing of one analog input voltage signal from other gauges such as a capacitance diaphragm gauge or INFICON vacuum gauge modules PGE300, PGE500 or BAG302.</p>
ALT GAUGE	<p>[Factory default = 10 TORR CDG]</p> <p>Ignore this menu if you have selected CG2 in the SET CG2 - ALT menu above. If you have selected ANALOG INPUT in the SET CG2 - ALT menu above, the ALT GAUGE menu selection is used to assign the type of alternate gauge.</p> <ul style="list-style-type: none"> • Select 100 mTORR CDG for a 100 mTorr Capacitance Manometer / Diaphragm Gauge (CDG) with 0-10 Vdc analog output. • Select 20 TORR CDG for a 20 Torr full scale CDG with 0-10 V (dc) analog output. Other full scale selections are 50 TORR CDG, 100 TORR CDG, 200 TORR CDG, 500 TORR CDG, 1000 TORR CDG, 10 mTORR CDG, 20 mTORR CDG, 50 mTORR CDG, 100 mTORR CDG, 250 mTORR CDG, 500 mTORR CDG, 1 TORR CDG, 2 TORR CDG and 5 TORR CDG. • Select ITI LOG CG if you are using INFICON's convection gauge modules such as the PGE300 or PGE500 with a Log-linear analog output. • ITI LOG IG7V is reserved for future use. Currently not applicable. • Select ITI LOG IG if you are using INFICON's ionization gauge module such as the BAG302 IG with a Log-linear analog output. • Select ITI NON-LINEA if you are using INFICON's convection gauge modules such as the PGE300 or PGE500 with a non-linear analog output.
ALT GAUGE CAL	<p>[Factory default = Factory Set Number]</p> <p>Ignore this menu if you have selected CG2 in the SET CG2 - ALT menu above. If you have selected ANALOG INPUT in the SET CG2 - ALT menu above, the ALT GAUGE CAL menu selection is used to optimize the analog input calibration. It is recommended that the user not make this adjustment unless the displayed alternate gauge pressure (CG2/ALT display channel) do not closely match the expected pressure from the analog input calculations.</p> <p>Example - To perform ALT GAUGE CAL if ALT GAUGE menu is selected for a 1000 TORR CDG. Connect both the CDG and a high resolution voltmeter to the + and – terminals of the VGC083 Analog Input Connector labeled AI. With CDG exposed to atmosphere, measure the analog input from the CDG at the VGC083 Analog Input Connector and calculate the corresponding pressure. In the ALT GAUGE CAL screen use the UP or DOWN keys to adjust the displayed pressure by the VGC083 to match the calculated pressure from the CDG analog signal. For example, if the analog input signal from the CDG is at 7.600 volts representing 760 Torr for a 1000 TORR CDG, then adjust the ALT GAUGE CAL so that the VGC083 also displays 760 Torr. For other CDG ranges always use CDG's full scale pressure value to perform calibration. For example, if you are using a 100 TORR CDG, evacuate your system pressure to 100 Torr and use the same calibration procedure above.</p>

Example - To perform ALT GAUGE CAL if ALT GAUGE menu is selected for ITI LOG CG, ITI LOG IG or ITI NON-LINE. When using other INFICON vacuum gauge modules such as PGE300, PGE500 or BAG302 as alternate gauges to CG2, the analog output signals from these devices can be used to display pressure in the CG2/ALT display channel. Connect the analog output from these devices to the + and – terminals of the VGC083 Analog Input Connector labeled AI. In the ALT GAUGE CAL screen use the UP or DOWN keys to adjust the displayed pressure by the VGC083 to match the pressure reading on the modules.

NOTE As you adjust the analog output, the number being displayed in the ALT GAUGE CAL screen represents the millivolts offset from zero volts that is being used internally for the analog input gain adjustment.

- I - O STATUS

[Factory default = DEGAS STATUS]

A degas status or an error condition output signal is available from the DIGITAL I/O connector. If selected for DEGAS STATUS, this can be used as an output signal to other external instruments to confirm that degas is on or off. If selected for ERROR STATUS, this can be used as an output signal to other external instruments to confirm whether there is an error condition.

DEFAULTS

[Factory default = PRESS ENTER TO SET OR MENU TO EXIT]

The system can be returned to the original factory settings by using the ENTER key to set factory defaults. The IG filament must be off (sensors off) in order to reset defaults.

If you reset all values to original factory default settings, you would need to repeat the initial setup procedure for the convection gauges as described in section 5.6 and reprogram other parameters as required.

6.5.2 ION GAUGE

NOTICE As mentioned previously the VGC083A/B controller is shipped from the factory with the ION GAUGE menu default parameters for the nude or glass IG. If you are using the BAG055 Mini IG, connect the Mini IG cable at the controller first, turn power on, access the SETUP UNIT Menu and set 'DEFAULTS'. This is recommended only one time at the initial set-up and it enables the controller realize its operating the BAG055 Mini IG and will set the default ION GAUGE menu parameters for BAG055. Always power off the unit before disconnecting the IG cable and reconnect the IG cable before turning the power on to ensure proper operation.

Before you activate the ion gauge/filament, make sure you understand all instructions and information provided in this manual and the Operating Manual for the PGE050 convection gauge. Furthermore, you should ensure you have fully configured the VGC083 control unit to your operational requirements before turning the filaments on. When using the BAG050 / 051 / 052 / 053 and prior to turning on the ion gauge filament you should ensure the pressure is below 1.00E-03 Torr (1 mTorr) with emission current set at 100 μ A; 5.00E-04 Torr with emission current set at 4 mA and 1.00E-04 Torr with emission current set at 10 mA. When using the BAG055 Mini IG and prior to turning on the ion gauge filament you should ensure the pressure is below 5.00E-02 Torr (10 mTorr) with emission current set at 100 μ A and 1.00E-03 Torr with emission current set at 4 mA.

 **CAUTION!** Due to the risk of filament failure caused by inadvertent exposure to oxidizing gases or gas mixtures, never use another gauge to automatically turn off the ion gauge when the ion gauge filament in use is constructed of tungsten (yttria coated iridium filament is okay). The response time of other gauges may not allow for timely turn off of the filament leading to filament damage especially for tungsten filaments. Always turn the tungsten IG filament OFF manually before pressure is allowed to rise above 1.00E-03 Torr.

EMISS SELECT
For BAG050 / 051 / 052 / 053

[Factory default = IE = 100UA]

Use the Up and Down key to select emission current to 100 μ A, 4 mA, 10 mA, AUTO IE 100-4, AUTO IE 100-10. Then press ENTER to save setting. The selection of 100 μ A, 4 mA, 10 mA results in operation of the unit with a fixed emission current throughout the measurement range. Selection of AUTO IE 100-4 or AUTO IE 100-10 allows for automatic switching of the emission current. The automatic switching of the emission current is recommended when the user's pressure measurement range requires various emission current settings. See section 5.1 for more details about the emission current selection.

In clean applications and when operating at higher pressure ranges (5.00E-06 Torr to 1.00E-03 Torr) the 100 μ A emission setting is preferred. At lower operating pressures (1.00E-09 Torr to 5.00E-04 Torr) the 4 mA emission setting should be used. Many vacuum measurement equipment users prefer to use the 10 mA emission current setting when making measurements in the UHV pressure regime (below 1.00E-08 to 1.00E-11 Torr).

As described previously, the emission current can also be set to automatically switch between 100 μ A, 4 mA and 10 mA. This results in optimal and stable pressure readings over the entire measurement range from low to high vacuum.

Select AUTO IE 100-4 if you would like the emission current to automatically switch between 100 μ A and 4 mA. For example, if an application requires that pressure measurements be performed by the ion gauge from 5.00E-07 Torr up to 1.00E-03 Torr, then the user may want to consider selecting the AUTO IE 100-4 automatic switching feature of the emission current. The pressure trip point at which the emission current will switch from 100 μ A to 4 mA is defined by the value programmed in the AUTO IE1 TRIP menu below.

Select AUTO IE 100-10 if you would like the emission current to automatically switch between 100 μ A, 4 mA and 10 mA. For example, if an application requires that pressure measurements be performed by the ion gauge from 4.00E-10 Torr up to 1.00E-03 Torr, then the user may want to consider selecting the AUTO IE 100-10 automatic switching feature of the emission current. In this case, the pressure trip point at which the emission current will switch from 100 μ A to 4 mA is defined by the value programmed in the AUTO IE1 TRIP menu below and pressure trip point at which the emission current will switch from 4 mA to 10 mA is defined by the value programmed in the AUTO IE2 TRIP menu below.

NOTE

If you plan to use a convection gauge or an alternate gauge to control the ionization gauge filament on/off function (see IG CONTROL menu below), you will only have 100 μ A and 4 mA emission current selections available (not available with 10 mA emission current). However by selecting the AUTO IE 100-10 automatic switching feature here, you would be able to use these devices to control the ion gauge and operate at the 10 mA emission current as well.

EMISS SELECT
For BAG055 Mini IG

Use the Up and Down key to select emission current to 100 μ A, 4 mA or AUTO IE. Then press ENTER to save setting. The selection of 100 μ A, 4 mA, results in operation of the unit with a fixed emission current throughout the measurement range. Select AUTO IE to allow for automatic switching of the emission current. The automatic switching of the emission current is recommended when the user's pressure measurement range requires various emission current settings. See section 5.1 for more details about the emission current selection.

AUTO IE1 TRIP
For BAG050 / 051 / 052 / 053

[Factory default = 1.00E-05]

The default setting is DISABLED if EMISS SELECT menu above is set to 4 mA or 100 μ A. If the EMISS SELECT menu is set to AUTO IE 100-4, then the AUTO IE1 TRIP value programmed here (Factory default = 1.00E-05) allows the user to select the pressure at which emission current automatically switches from 100 μ A to 4 mA. For example, if the AUTO IE1 TRIP value is set to 1.00E-05 Torr, then the ion gauge will operate at the emission current of 100 μ A over the pressure measurement range of 1.00E-03 Torr to 1.00E-05 Torr. The emission current will then automatically switch to 4 mA at pressure of 1.00E-05 Torr or lower. The user has the choice of programming the AUTO IE1 TRIP point anywhere between 1.00E-06 to 1.00E-04 Torr.

AUTO IE2 TRIP
For BAG050 / 051 / 052 / 053

[Factory default = 1.00E-07]

The default setting is DISABLED if EMISS SELECT menu above is set to 4 mA or 100 µA. If the EMISS SELECT menu is set to AUTO IE 100-10, then the AUTO IE2 TRIP value programmed here (Factory default = 1.00E-07) allows the user to select the pressure at which emission current automatically switches from 4 mA to 10 mA. For example, if the AUTO IE2 TRIP value is set to 1.00E-07 Torr, then the ion gauge will operate at the emission current of 4 mA from the trip pressure value programmed for the AUTO IE1 TRIP menu above to 1.00E-07 Torr. The emission current will then automatically switch to 10 mA at pressure of 1.00E-07 Torr or lower. The user has the choice of programming the AUTO IE2 TRIP point anywhere between 1.00E-06 to 1.00E-08 Torr. Note that if the EMISS SELECT menu is set to AUTO IE 100-10, then the AUTO IE1 TRIP value above must still be programmed to select the desired pressure at which emission current automatically switches from 100 µA to 4 mA.

AUTO IE TRIP
For BA055

[Factory default = 1.00E-05]

The default setting is DISABLED if EMISS SELECT menu above is set to 4 mA or 100 µA. If the EMISS SELECT menu is set to AUTO IE 100-4, then the AUTO IE TRIP value programmed here (Factory default = 1.00E-05) allows the user to select the pressure at which emission current automatically switches from 100 µA to 4 mA. See example in AUTO IE1 TRIP above.

SELECT FIL

[Factory default = FILAMENT 1]

Allows the user to select which filament to operate: either Filament 1 or Filament 2.

NOTICE

It is highly recommended to periodically alternate operating filaments 1 and 2 if the filaments are the coated iridium type. An inactive, coated filament not operated for an extended period of time can cause failure of that filament to establish and maintain emission current. This will become more problematic in applications where the filament coating may become poisoned by process gas byproducts or materials that have outgassed from the process materials.

DEGAS TIME

[Factory default = 10 MINUTES for BAG050 / 051 / 052 / 053]
[Factory default = 2 MINUTES for BAG055 Mini IG]

The length of time, in minutes, degassing will run after it is initiated. The degas cycle can be selected from 2 to 30 minutes in duration.

SENSITIVITY (VGC083A)

[Factory default = 25.00 for BAG050]
[Factory default = 10.00 for BAG055 - Program actual S value marked on BAG055]

When using the BAG050 nude UHV EB-degas IG or equivalent nude IG, set sensitivity to 25 per Torr. When using the BAG055 Mini IG set sensitivity to the S value marked on the BAG055 sensor. If you are using a nude IG with a known sensitivity other than 25 per Torr, you may set the actual sensitivity for the IG head you are using. The Sensitivity constant used by the operating system for the pressure calculation is based on the following mathematical formula for the B-A ion gauge pressure measurement:

$$I_c = P \times S \times I_e$$

where P is Pressure, S is Sensitivity¹⁾; I_c is the collector current and I_e is the emission current.

¹⁾ Sensitivity for the B-A type ionization gauge is a constant. A number defined as the quantity of ions created and collected (collector current) per unit measure of pressure per the controlled quantity of emission current from which the ion current is generated. This setting can be useful for compensating the readout of pressure when measured by the ion gauge for gases other than nitrogen/air. Consult reachus@inficon.com for further discussion on the use of this setting for compensated readings. Typical sensitivity for the nude UHV EB-degas ionization gauge used is 25 per Torr (25 Torr⁻¹). Typical sensitivity for the BAG055 Mini IG used is 10 per Torr (10 Torr⁻¹).

 **CAUTION!** The user assumes all risks if the SENSITIVITY is programmed to a value not matching the actual head (sensor) sensitivity described above. Failure to ensure that the VGC083A is programmed for the actual sensitivity of the head it is used with may result in pressure readings that are not true pressure. Equipment

damage due to incorrect pressure readings and improper system control functions as a result of incorrect pressure measurement readings may result.

SENSITIVITY (VGC083B)

[Factory default = 10.00 for BAG051 / 052 / 053]

When using the resistive or I²R degas nude IG (Series BAG051, or equivalent) or glass enclosed IG (BAG052 / 053, or equivalent) set sensitivity to 10 per Torr. If you are using an IG with a known sensitivity other than 10 per Torr, you may set the actual sensitivity for the IG head you are using. The Sensitivity constant used by the operating system for the pressure calculation is based on the following mathematical formula for the B-A ion gauge pressure measurement:

$$I_c = P \times S \times I_e$$

where P is Pressure, S is Sensitivity¹⁾; I_c is the collector current and I_e is the emission current.

- ¹⁾ Sensitivity for the B-A type ionization gauge is a constant. A number defined as the quantity of ions created and collected (collector current) per unit measure of pressure per the controlled quantity of emission current from which the ion current is generated. This setting can be useful for compensating the readout of pressure when measured by the ion gauge for gases other than nitrogen/air. Consult reachus@inficon.com for further discussion on the use of this setting for compensated readings. Typical sensitivity for the resistive or I²R degas ionization gauges used is 10 per Torr (10 Torr⁻¹).



CAUTION! The user assumes all risks if the SENSITIVITY is programmed to a value not matching the actual head (sensor) sensitivity described above. Failure to ensure that the VGC083B is programmed for the actual sensitivity of the head it is used with may result in pressure readings that are not true pressure. Equipment damage due to incorrect pressure readings and improper system control functions as a result of incorrect pressure measurement readings may result.

OVER PRES 100

[Factory default = 1.00E-03 for BAG050 / 051 / 052 / 053]

[Factory default = 5.00E-02 for BAG 055 Mini IG]

This function allows the user to set the pressure at which the gauge will turn off when the emission current is running at 100 µA.

The overpressure shut down values are adjustable when emission current selected is 100 µA. However with BAG050 / 051 / 052 / 053 when setting the overpressure value at a higher pressure than 1.00E-03 Torr (1.00E-02 Torr maximum), review your ion gauge head specifications to determine the maximum pressure your ion gauge head is capable of measuring (BAG05x nuder /glass series heads are capable of measuring a maximum pressure of 1.00E-03 Torr). When using the BAG055 Mini IG this value cannot be set to a pressure higher than 5.00E-02.

NOTE

With BAG050 / 051 / 052 / 053 the overpressure shut down value is factory set to 5.00E-04 Torr and 1.00E-04 Torr when emission current selected is 4 mA or 10 mA respectively and cannot be changed by the user.

With BAG055 Mini IG the overpressure shut down value is factory set to 1.00E-03 Torr when emission current selected is 4 mA and cannot be changed by the user.

IG TRIP PRES

[Factory default = 1.00E-03]

This setting allows the user to select a pressure value at which CG1 or CG2 or alternate gauge can turn the IG filament on. This is applicable only when the gauge is operating at 100 µA or 4 mA emission current setting (not applicable with 10 mA emission current) or in the automatic emission current switching mode (EMISSION SELECT = AUTO IE) and the IG CONTROL mode below is set to CG1, CG2 or ALT GAUGE.

The IG TRIP PRES default value when using an emission current of 100 µA is 1.00E-03 Torr but it can be set to value as high as 1.00E-02 Torr with BAG050 / 051 / 052 / 053 and 5.00E-02 Torr for BAG055 Mini IG. However, when setting the IG TRIP PRES value at a higher pressure than 1.00E-03 Torr, review your ion gauge head specifications to determine the maximum pressure your ion gauge head is capable of measuring (BAG05x nude/glass series heads are capable of measuring a maximum pressure of 1.00E-03 Torr).

When using the BAG050 / 051 / 052 / 053 the user does not have the choice to select a turn on point for the IG when the 4 mA or 10 mA emission current has been selected. The IG turn on is always fixed at 5.00E-04 Torr and 1.00E-04 Torr when the emission current is set for 4 mA or 10 mA respectively. When using the BAG055

Mini IG the turn on point for the IG when the 4 mA emission current has been selected is fixed at 1.00E-03 Torr.

IG CONTROL

[Factory default = MANUAL MODE]

This function allows the user to choose the source of control for the IG. The IG can be controlled from the Front Panel (MANUAL MODE), CG1, CG2 or the ALT GAUGE (alternate gauge).

Select MANUAL MODE if you wish to use the front panel programming keys to turn the ion gauge head filament to the on or off state.

Select CG1, CG2 or ALT GAUGE if the pressure measurement from CG1 or CG2 or the Alternate Gauge is to be used to automatically turn the ion gauge head filament on and off.

⚠ CAUTION! Never use another gauge to automatically turn off the ion gauge when the ion gauge filament in use is constructed of tungsten material (a coated filament such as the yttria coated iridium version is okay). The response time of other gauges may not allow for timely turn off of the tungsten filament leading to possible filament damage. Always turn the IG filament OFF manually before pressure is allowed to rise above 1.00E-03 Torr.

When CG1, CG2 or ALT GAUGE is selected in the IG CONTROL menu and the ion gauge emission current is set to 100 μ A, the ion gauge filament will turn on when the pressure measured by CG1, CG2 or Alternate Gauge drops below the value programmed in the IG TRIP PRES above. The ion gauge filament will turn off when the pressure measured by CG1, CG2 or Alternate Gauge rises above the value programmed for the IG TRIP PRES.

With BAG050 / 051 / 052 / 053 If the ion gauge emission current is set to 4 mA, the ion gauge filament will turn on when the pressure measured by CG1, CG2 or Alternate Gauge drops below 5.00E-04 Torr. The ion gauge filament will turn off when the pressure measured by CG1, CG2 or Alternate Gauge rises above 5.00E-04 Torr. If the ion gauge emission current is set to 10 mA, the ion gauge filament cannot be turned on using the pressure measurements from CG1, CG2 or Alternate Gauge. However by selecting the AUTO IE 100-10 automatic menu above, you would be able to use these devices to control the ion gauge and operate at the 10 mA emission current as well.

With BAG055 if the ion gauge emission current is set to 4 mA, the ion gauge filament will turn on when the pressure measured by CG1, CG2 or Alternate Gauge drops below 1.00E-03 Torr. The ion gauge filament will turn off when the pressure measured by CG1, CG2 or Alternate Gauge rises above 1.00E-03 Torr.

NOTE

When CG1, CG2 or ALT GAUGE is selected in the IG CONTROL menu, the user cannot turn on or turn off the IG filament manually using the IG ON/OFF soft-keys of the front panel, RS232, RS485 or DIGITAL I/O signals. In this case the IG filament turn on or turn off is automatically controlled by CG1, CG2 or the Alternate Gauge.

CAL FACTORS (VGC083A future use only)

[Factory default = C0, C1, C2, C3, C4, C5 all factory-set to 50]

Do not change CAL FACTORS values. This menu is intended for future enhancement of the VGC083A capabilities. Leave C0, C1, C2, C3, C4, and C5 CAL FACTORS values at the factory default setting of 50. Changing these values to a number other than 50 will result in inaccurate vacuum pressure measurements.

⚠ CAUTION! You must be aware of possible risks of inadvertently starting emission (turning the IG filament to ON) when using an alternate gauge like a capacitance diaphragm gauge as a source of control for turning the ion gauge on and off. Failure to follow the recommended procedures for ensuring that you do not inadvertently allow the ion gauge head filament to turn on may result in equipment damage.

To minimize the risk associated with this using an alternate gauge to control the ion gauge head filament, follow these recommended steps below precisely:

- 1) Before selecting ALTERNATE GAUGE in the SETUP UNIT menu, the user should turn off power to the VGC083.
- 2) Connect the alternate gauge to the VGC083.

- 3) Apply power to the alternate gauge.
- 4) Next apply power to the VGC083.
- 5) Select ALTERNATE GAUGE in the SETUP UNIT menu.

It is always good industry practice to avoid hot-swapping of Cables.

6.5.3 CONVEC GAUGE

NOTICE

It is important to set vacuum and atmosphere when initially setting up the convection gauges. See Convection Gauge Initial Setup section 5.6

This programming menu allows the user to set the atmospheric pressure reading (also known as the "span" adjustment) and vacuum reading ("zero" point) for convection gauges CG1 and CG2. INFICON advises that you first determine if the "span" (ATM) adjustment of your measurement device is set properly before setting the "zero" (VAC) adjustment. It is good practice to perform the sequence of checking and adjusting ATM (span) then VAC (zero) and then, finally re-checking the ATM setting to ensure that the circuitry is properly balanced for use in measuring pressure throughout the intended measurement range. Press the ENTER key to access the CONVEC GAUGE menu for configuring the convection gauges.

SET VAC CG1

[Factory default = 0.00E 00]

Press the ENTER key to access the SET VAC CG1 screen.

1. To properly set the vacuum reading ("zero" point), with CG1 installed on your vacuum system, the gauge should be evacuated to a pressure below 1.00E-04 Torr (0.1 mTorr). [Factory default = 0.00E+0 Torr]
2. When the known vacuum system pressure is below 0.1 mTorr and If you want to set zero at 0.00E+0, then press the ENTER key repeatedly until the SET VAC CG1 appears on the display again. The zero point (displayed pressure reading with gauge exposed to vacuum) is now set.

If you want to set the 'zero' pressure reading to a number higher than 0.00E+0, then press the UP or DOWN keys at each of the high-lighted numeral locations until the desired number is reached; then press the ENTER key repeatedly until the SET VAC CG1 appears on the display again. The new "zero point" is now set. Due to the nature of circuit operation and head electrical control that cover a wide range of measurement by a convection gauge, it is advised that one first check and adjust, if necessary, the "span" and "zero" to ensure that all measurements made between these two, adjusted settings are as accurate as possible.

SET ATM CG1

[Factory default = 7.60E 02 TORR]

Press the ENTER key to access the SET ATM CG1 screen.

Backfill the vacuum vessel /chamber with nitrogen gas to a known pressure between 400 Torr and 1000 Torr. Alternatively, if your local uncorrected barometric pressure (air) is known, simply vent your vacuum system chamber to expose the gauge to the local atmospheric pressure. When desired system pressure is stable, adjust the pressure on the screen to the known value using the UP or DOWN keys. Press the ENTER key to move to the next digit and use the UP or DOWN keys to decrease or increase the value of that digit. Continue pressing the ENTER key until the SET ATM CG1 reappears on the display. The new atmosphere point is now set. For example, if your known local uncorrected barometric pressure is 760 Torr, enter 760 in the SET ATM screen. The main pressure measurement screen will now display 760 Torr while the gauge is at atmosphere.

SET VAC CG2

[Factory default = PRESS ENTER TO SET VAC]

Same as SET VAC CG1 above, except for CG2

SET ATM CG2

[Factory default = 7.60E 02 TORR]

Same as SET ATM CG1 above, except for CG2.

6.5.4 RELAYS

Press the ENTER key to access the RELAYS menu for configuring the setpoint relays.

ASSIGN REL 1	<p>[Factory default = ION GAUGE]</p> <p>This assigns Relay #1 to the ion gauge, CG1, CG2 or ALT GAUGE (alternate gauge).</p>
ASSIGN REL 2	<p>[Factory default = CG1]</p> <p>ASSIGN RELAY 2; same choices as ASSIGN RELAY 1 above</p>
ASSIGN REL 3	<p>[Factory default = CG2]</p> <p>ASSIGN RELAY 3; same choices as ASSIGN RELAY 1 above</p>
ASSIGN REL 4	<p>[Factory default = ION GAUGE]</p> <p>ASSIGN RELAY 4; same choices as ASSIGN RELAY 1 above</p>
ASSIGN REL 5	<p>[Factory default = CG1]</p> <p>ASSIGN RELAY 5; same choices as ASSIGN RELAY 1 above</p>
ASSIGN REL 6	<p>[Factory default = CG2]</p> <p>ASSIGN RELAY 6; same choices as ASSIGN RELAY 1 above</p>
REL 1 LO TRIP	<p>[Factory default = 1.00E-06]</p> <p>This setpoint corresponds to the turn on point for Relay #1. Relay #1 will turn on when the pressure drops below this setting. If you are unable to increase the value of REL 1 LO TRIP (VGC083 responding with the message "NO CHANGE"), you must first access the REL 1 HI TRIP menu below and increase that value to a number higher than the value of the REL 1 LO TRIP you are trying to set. Ensure the REL 1 LO TRIP setpoint value you are programming is within the measurement range of the specific gauge the relay is assigned to.</p>
REL 1 HI TRIP	<p>[Factory default = 2.00E-06]</p> <p>This setpoint corresponds to the turn off point for Relay #1. Relay #1 will turn off when the pressure rises above this setting. If you are unable to decrease the value of REL 1 HI TRIP (VGC083 responding with the message "NO CHANGE"), you must first access the REL 1 LO TRIP menu above and decrease that value to a number lower than the value of the REL 1 HI TRIP you are trying to set. Ensure the REL 1 HI TRIP setpoint value you are programming is within the measurement range of the specific gauge the relay is assigned to.</p>
REL 2 LO TRIP	<p>[Factory default = 1.00E-01]</p> <p>(RELAY 2 LO TRIP; same info as RELAY 1 LO TRIP above)</p>
REL 2 HI TRIP	<p>[Factory default = 2.00E-01]</p> <p>(RELAY 2 HI TRIP; same info as RELAY 1 HI TRIP above)</p>
REL 3 LO TRIP	<p>[Factory default = 1.00E-01]</p> <p>(RELAY 3 LO TRIP; same info as RELAY 1 LO TRIP above)</p>
REL 3 HI TRIP	<p>[Factory default = 2.00E-01]</p> <p>(RELAY 3 HI TRIP; same info as RELAY 1 HI TRIP above)</p>

REL 4 LO TRIP	[Factory default = 1.00E-06] (RELAY 4 LO TRIP; same info as RELAY 1 LO TRIP above)
REL 4 HI TRIP	[Factory default = 2.00E-06] (RELAY 4 HI TRIP; same info as RELAY 1 HI TRIP above)
REL 5 LO TRIP	[Factory default = 1.00E-01] (RELAY 5 LO TRIP; same info as RELAY 1 LO TRIP above)
REL 5 HI TRIP	[Factory default = 2.00E-01] (RELAY 5 HI TRIP; same info as RELAY 1 HI TRIP above)
REL 6 LO TRIP	[Factory default = 1.00E-01] (RELAY 6 LO TRIP; same info as RELAY 1 LO TRIP above)
REL 6 HI TRIP	[Factory default = 2.00E-01] (RELAY 6 HI TRIP; same info as RELAY 1 HI TRIP above)
REL 1 LO DELY	[Factory default = 0.0 SECONDS] Depending on the age of your controller this relay delay time menu may not be available in your product. In certain process control schemes, it may be desirable to have a delay period between the time the pressure reaches the REL 1 LO TRIP point value described above and Relay 1 gets turned on. REL 1 LO DELY menu provides the user the ability to set such delay time in seconds.
REL 1 HI DELY	[Factory default = 0.0 SECONDS] Depending on the age of your controller this relay delay time menu may not be available in your product. In certain process control schemes, it may be desirable to have a delay period between the time the pressure reaches the REL 1 HI TRIP point value described above and Relay 1 gets turned off. REL 1 HI DELY menu provides the user the ability to set such delay time in seconds.
REL 2 LO DELY	[Factory default = 0.0 SECONDS] (REL 2 LO DELY: same info as REL 1 LO DELY above)
REL 2 HI DELY	[Factory default = 0.0 SECONDS] (REL 2 HI DELY: same info as REL 1 HI DELY above)
REL 3 LO DELY	[Factory default = 0.0 SECONDS] (REL 3 LO DELY: same info as REL 1 LO DELY above)
REL 3 HI DELY	[Factory default = 0.0 SECONDS] (REL 3 HI DELY: same info as REL 1 HI DELY above)
REL 4 LO DELY	[Factory default = 0.0 SECONDS] (REL 4 LO DELY: same info as REL 1 LO DELY above)
REL 4 HI DELY	[Factory default = 0.0 SECONDS] (REL 4 HI DELY: same info as REL 1 HI DELY above)
REL 5 LO DELY	[Factory default = 0.0 SECONDS] (REL 5 LO DELY: same info as REL 1 LO DELY above)

REL 5 HI DELY [Factory default = 0.0 SECONDS]
(REL 5 HI DELY: same info as REL 1 HI DELY above)

REL 6 LO DELY [Factory default = 0.0 SECONDS]
(REL 6 LO DELY: same info as REL 1 LO DELY above)

REL 6 HI DELY [Factory default = 0.0 SECONDS]
(REL 6 HI DELY: same info as REL 1 HI DELY above)

TEST RELAYS [Factory default = OFF]

This allows the user to manually toggle the relays on and off to test for correct external circuit wiring and ensure polarity is as desired. Press ENTER to access the TEST RELAYS menu. Select a specific relay by pressing the ENTER key so that the relay number is highlighted. Press the UP or DOWN key to energize the specific relay.

Relays will return to the previous state after exiting the TEST RELAYS menu.

6.5.5 Analog Output

The VGC083 provides three analog outputs proportional to the pressure measured by the ionization gauge, the selected convection gauge (CG1 or CG2) or a continuous, combined output signal from the IG and CG1 (IG - CG1) for full range measurement. Press the ENTER key to access the ANALOG OUTPUT menu for configuring the analog outputs.

ANALOG OUT 1 [Factory default = CG1 - CG1]

This menu provides various scaling and gauge type selections for Analog Output #1. Use the UP and DOWN keys to select the desired analog output configuration from the following available choices.

IG - CG1 0.5 - 7V	Log-linear analog output combining IG & CG1 as one signal
IG - CG2 0.5 - 7V	Log-linear analog output combining IG & CG2 as one signal
IG - ALT 0.5 - 7V	Log-linear analog output combining IG & Alternate gauge as one signal
IG LOG N - 10	Log-linear analog output for IG only, output also compatible with GP 307, 350
- IG LOG N - 11	Log-linear analog output for IG only, output also compatible with GP 307, 350, 358
IG LOG N - 12	Log-linear analog output for IG only, output also compatible with GP 307, 350
IG 1.8 - 8.7V	Log-Linear analog output for IG only
IG LINEAR	Linear analog output for IG only, output also compatible with GP 307
ALT LINEAR	Linear analog output for alternate gauge only
ALT CG 1-8V	Log-linear analog output if alternate gauge connected is an INFICON PGE300 or PGE500
ALT IG LOGN10	Log-linear analog output if alternate gauge connected is an INFICON BAG302
CG1 1 - 8V	Log-linear analog output for CG1
CG2 1 - 8V	Log-linear analog output for CG2
CG1 0 - 7V	Log-linear analog output for CG1 , output also compatible with GP 307,350,358
CG2 0 - 7V	Log-linear analog output for CG2 , output also compatible with GP 307,350,358
CG1 NON - LIN	Non-linear analog output for CG1
CG2 NON - LIN	Non-linear analog output for CG2
CG1 LINEAR	Linear analog output for CG1
CG2 LINEAR	Linear analog output for CG2

Select **"IG - CG1 0.5 - 7V"** as the analog output type to set the analog output voltage proportional to the pressure measured by the combination of IG plus CG1. This selection combines the analog output from the IG and CG1 as one signal to provide a log-linear analog output voltage of 0.5 volts to 7 volts with a scaling factor of 0.5 V/decade of measured pressure. The log-linear output signal and pressure are related by the following formulas when Pressure Unit of measurement is in Torr and mbar: $P = 10^{(\text{volts} - 5.5) / (0.5)}$ where P is the pressure in Torr or mbar, and V is the output signal in volts. Refer to section 7.1 for details regarding this type of output signal.

Select **"IG - CG2 0.5 - 7V"** as the analog output type to set the analog output voltage proportional to the pressure measured by the combination of IG plus CG2. The analog output characteristics is the same as described for **"IG - CG1 0.5 - 7V"** above. Note that your controller may not have this menu as it was added for units shipped in June 2017 and beyond.

Select **"IG - ALT 0.5 - 7V"** as the analog output type to set the analog output voltage proportional to the pressure measured by the combination of IG plus the Alternate gauge. The analog output characteristics is the same as described for **"IG - CG1 0.5 - 7V"** above. Note that the **"IG - ALT 0.5 - 7V"** selection is mainly intended for use with an alternate gauge which has a wide measurement range from atmosphere to the turn-on point for the ion gauge. INFICON convection gauges such as the PGE300 or PGE500 provide this capability. If you are using a capacitance diaphragm gauge (CDG) as an alternate gauge you may want to consider a different output since a single CDG may not provide measurements from atmosphere to the turn-on point for the ion gauge. Note that your controller may not have this menu as it was added for units shipped in June 2017 and beyond.

Select **"IG LOG N - 10"** as the analog output type to set the analog output voltage proportional to the pressure measured by the ion gauge only. This selection provides an output voltage that is linear with respect to the common logarithm of pressure, i.e., log-linear analog output of 0 to 9 volts with a scaling factor of 1 V/decade of measured pressure. The log-linear output signal and pressure are related by the following formulas when Pressure Unit of measurement is in Torr and mbar: $P = 10^{(\text{volts} - 10)}$ where P is the pressure in Torr or mbar, and V is the output signal in volts. Refer to section 7.2 for details regarding this type of output signal. This selection is compatible with the analog output scaling from the Granville-Phillips 307 and 350 controllers.

Select **"IG LOG N - 11"** as the analog output type to set the analog output voltage proportional to the pressure measured by the ion gauge only. This selection provides an output voltage that is linear with respect to the common logarithm of pressure, i.e., log-linear analog output of 0 to 10 volts with a scaling factor of 1 V / decade of measured pressure. The log-linear output signal and pressure are related by the following formulas when Pressure Unit of measurement is in Torr and mbar: $P = 10^{(\text{volts} - 11)}$ where P is the pressure in Torr or mbar, and V is the output signal in volts. Refer to section 7.3 for details regarding this type of output signal. This selection is also compatible with a certain analog output scaling from the Granville-Phillips 307, 350 and 358 controllers.

Select **"IG LOG N - 12"** as the analog output type to set the analog output voltage proportional to the pressure measured by the ion gauge only. This selection provides an output voltage that is linear with respect to the common logarithm of pressure, i.e., log-linear analog output of 0 to 11 volts with a scaling factor of 1 V / decade of measured pressure. The log-linear output signal and pressure are related by the following formulas when Pressure Unit of measurement is in Torr and mbar: $P = 10^{(\text{volts} - 12)}$ where P is the pressure in Torr or mbar, and V is the output signal in volts. Refer to section 7.4 for details regarding this type of output signal. This selection is also compatible with a certain analog output scaling from the Granville-Phillips 307 and 350 controllers.

Select **"IG 1.8 - 8.7V"** as the analog output type to set the analog output voltage proportional to the pressure measured by the ion gauge only. This selection provides an output voltage that is linear with respect to the common logarithm of pressure, i.e., log-linear analog output of 1.8 to 8.7 volts with a scaling factor of 0.8 V/decade of measured pressure. The log-linear output signal and pressure are related by the following formulas when Pressure Unit of measurement is in Torr $P = 10^{((1.25 \times \text{volts}) - 12.875)}$ where P is the pressure in Torr and V is the output signal in volts. Refer to section 7.5 for details regarding this type of output signal.

Select **"IG LINEAR"** as the analog output type to provide a 0-10 Vdc output signal that has a direct linear relationship to the displayed pressure measured by the ion gauge only. This selection covers 3 decades of pressure change. For example, if the maximum pressure selected is 1.00E-03 Torr (value programmed for AOUT

LIN 1 or AOUT LIN 2 or AOUT LIN 3 menu below), then the instrument provides a 10 volt analog output signal when pressure is at 1.00E-03 Torr and the minimum pressure is automatically set to 1.00E-06 Torr, with a corresponding minimum voltage output of 0.01 volts. If your application requires the IG analog output voltage to cover a pressure range exceeding three decades, then consider using the log-linear analog outputs. Refer to section 7.6 for details regarding this type of output signal. This selection is also compatible with a certain analog output scaling from the Granville-Phillips 307 controller.

Select "**ALT LINEAR**" only if you have selected ANALOG INPUT in the SET CG2 - ALT menu intended for use with a CDG device as an alternate gauge to CG2. If such is the case, this analog output type provides a 0-10 Vdc analog output signal that has a direct linear relationship to the displayed pressure measured by the alternate gauge. This selection covers 3 decades of pressure change. Essentially, this allows retransmission of the same analog input signal being received by the VGC083. For example, if ALT GAUGE selected is 1000 TORR CDG, the maximum pressure should also be programmed as 1.00E03 Torr (value programmed for AOUT LIN 1 or AOUT LIN 2 or AOUT LIN 3 menu below), then the instrument provides a 10 volt analog output signal when pressure is at 1.00E03 Torr and the minimum pressure is automatically set to 1.00 Torr, with a corresponding minimum voltage output of 0.01 volts.

Select "**ALT CG 1-8V**" only if you have selected ANALOG INPUT in the SET CG2 - ALT menu intended for use with an INFICON PGE300 or PGE500 convection vacuum gauge module as an alternate gauge to CG2. Essentially, this allows retransmission of the same analog input signal being received from the PGE300 or PGE500. This selection provides an output voltage that is linear with respect to the common logarithm of pressure, i.e., log-linear analog output of 1 to 8 volts with a scaling factor of 1 V/decade of measured pressure. The log-linear output signal and pressure are related by the following formulas when Pressure Unit of measurement is in Torr and mbar: $P = 10^{(volts - 5)}$ where P is the pressure in Torr or mbar, and V is the output signal in volts.

Select "**ALT IG LOGN10**" only if you have selected ANALOG INPUT in the SET CG2 - ALT menu intended for use with an INFICON BAG302 ionization vacuum gauge module as an alternate gauge to CG2. Essentially, this allows retransmission of the same analog input signal being received from the BAG302. This selection provides an output voltage that is linear with respect to the common logarithm of pressure, i.e., log-linear analog output of 0 to 9 volts with a scaling factor of 1 V/decade of measured pressure. The log-linear output signal and pressure are related by the following formulas when Pressure Unit of measurement is in Torr and mbar: $P = 10^{(volts - 10)}$ where P is the pressure in Torr or mbar, and V is the output signal in volts.

Select "**CG1 1 - 8V**" as the analog output type to set the analog output voltage proportional to the pressure measured by convection gauge CG1. This selection provides an output voltage that is linear with respect to the common logarithm of pressure, i.e., log-linear analog output of 1 to 8 volts with a scaling factor of 1 V/decade of measured pressure. The log-linear output signal and pressure are related by the following formulas when Pressure Unit of measurement is in Torr and mbar: $P = 10^{(volts - 5)}$ where P is the pressure in Torr or mbar, and V is the output signal in volts. Refer to section 7.7 for details regarding this type of output signal.

Select "**CG2 1 - 8V**" for CG2. Same as CG1 1 - 8V above, except for CG2.

Select "**CG1 0 - 7V**" as the analog output type to set the analog output voltage proportional to the pressure measured by convection gauge CG1. This selection provides an output voltage that is linear with respect to the common logarithm of pressure, i.e., log-linear analog output of 0 to 7 volts with a scaling factor of 1 V / decade of measured pressure. The log-linear output signal and pressure are related by the following formulas when Pressure Unit of measurement is in Torr and mbar: $P = 10^{(volts - 4)}$ where P is the pressure in Torr or mbar, and V is the output signal in volts. Refer to section 7.8 for details regarding this type of output signal. This selection is compatible with the analog output scaling from the Granville-Phillips 307, 350 and 358 controllers.

Select "**CG2 0 - 7V**" for CG2. Same as CG1 0 - 7V above, except for CG2. ^

Select "**CG1 NON - LIN**" as the analog output type to set the analog output (non-linear) voltage proportional to the pressure measured by convection gauge CG1. This produces a non-linear analog output signal of 0.375 to 5.659 V (dc) for 0 to 1000 Torr of N₂, roughly in the shape of an "S" curve. Refer to section 7.9 for details regarding this type of output signal. Note - This non-linear analog output is also equivalent to the Granville-Phillips® Mini-Convectron® non-linear S-curve analog output.

Select "**CG2 NON - LIN**" for CG2. Same as CG1 NON - LIN above, except for CG2.

Select "**CG1 LINEAR**" as the analog output type to provide a 0-10 Vdc output signal that has a direct linear relationship to the displayed pressure measured by CG1 only. This selection covers 3 decades of pressure change. For example, if the maximum pressure selected is 1.00 Torr (value programmed for AOUT LIN 1 menu below), then the instrument provides a 10 volt analog output signal when pressure is at 1.00 Torr and the minimum pressure is automatically set to 1 mTorr (1.00E-03 Torr), with a corresponding minimum voltage output of 0.01 volts. If your application requires CG1 or the analog output voltage to cover a pressure range exceeding three decades, then consider using the log-linear analog output type. Refer to section 7.10 for details regarding this type of output signal.

Select "**CG2 LINEAR**" for CG2. Same as CG1 LINEAR above, except for CG2.

ANALOG OUT 2

[Factory default = CG1 1 - 8V]

(Same selection choices as ANALOG OUT 1 above)

ANALOG OUT 3

[Factory default = CG2 1 - 8V]

(Same selection choices as ANALOG OUT 1 above)

AOUT CAL 1

[Factory default = Factory Set]

This has been pre-set in the factory and is used to optimize the analog output calibration. It is recommended that the user not make this adjustment unless the displayed pressure on the VGC083 and the resulting pressure recorded from the analog output do not match closely.

To perform AOUT CAL 1 adjustment if ANALOG OUTPUT 1 is programmed for IG LOG, IG LINEAR or ALT IG LOGN10. Connect the IG to the VGC083 and connect the VGC083 analog output 1 to a high resolution voltmeter, your system, PLC, etc. Evacuate your vacuum system to a low enough pressure for the IG to operate. Establish a system pressure so that the displayed IG reading is preferably at the high end of any decade (for example 9.00E-05 as opposed to 1.00E-05). In the AOUT CAL 1 screen use the UP or DOWN keys to adjust the analog output to match the corresponding pressure displayed on the IG pressure measurement display or the CG2/ALT display channel if using a BAG302 ion gauge module as an alternate gauge to CG2.

Example: ANALOG OUTPUT 1 is programmed for "IG LOG N - 10". The VGC083 IG display is registering a pressure reading of 9.00E-05 Torr. Based on the equation and table given in section 7.2 the expected analog output at 9.00E-05 Torr is 5.9542 V. While in the AOUT CAL 1 screen, use the UP or DOWN keys to set the analog output to 5.9542 V as recorded by your voltmeter. Alternatively, if the IG analog output is used to display the IG pressure on your PLC or system display console, simply adjust the AOUT CAL 1 so that the IG pressure displayed by your PLC (pressure established at the high end of any decade preferred) matches the IG pressure displayed by the VGC083. Note - As you adjust the analog output, the number being displayed in the AOUT CAL 1 screen represents the millivolts offset from zero volts that is being used internally for the analog output gain adjustment.

To perform AOUT CAL 1 adjustment if ANALOG OUTPUT 1 is programmed for IG - CG1, CG1, CG2, CG1/CG2NON-LIN, CG1/CG2 LINEAR, ALT CG 1-8V. Connect CG1 or CG2 to the VGC083 and connect the VGC083 analog output 1 to a high resolution voltmeter, your system, PLC, etc. While in the AOUT CAL 1 screen and with CG1 or CG2 exposed to atmosphere, use the UP or DOWN keys to adjust the analog output to match the corresponding pressure displayed on CG1 or CG2 pressure measurement display.

Example: The VGC083 ANALOG OUTPUT 1 is programmed for "CG1 1 - 8V". The VGC083 CG1 display is registering a pressure reading of 7.60E+02 Torr. Based on the equation and table given in section 7.7 the expected analog output at 7.60E+02

Torr is 7.881 V. Use the UP or DOWN keys in the AOUT CAL 1 screen to set the analog output to 7.881 V as recorded by your voltmeter. Alternatively, if the CG1 analog output is used to display the CG1 pressure on your PLC or system display console, simply adjust the AOUT CAL 1 while the gauge is exposed to atmosphere so that the CG1 atmospheric pressure displayed by your PLC matches the CG1 atmospheric pressure displayed by the VGC083. The AOUT CAL can be performed at any pressure between 400 Torr to 999 Torr (atmosphere recommended).
 Note - As you adjust the analog output, the number being displayed in the AOUT CAL 1 screen represents the millivolts offset from zero volts that is being used internally for the analog output gain adjustment.

To perform AOUT CAL 1 adjustment if ANALOG OUTPUT 1 is programmed for ALT LINEAR: Connect the CDG to the VGC083 and connect the VGC083 analog output 1 to a high resolution voltmeter, your system, PLC, etc. While in the AOUT CAL 1 screen and with the 1000 TORR CDG exposed to atmosphere, use the UP or DOWN keys to adjust the analog output to match the corresponding pressure displayed for the alternate gauge (CG2/ALT display channel).

Example: The VGC083 ANALOG OUTPUT 1 is programmed for "ALT LINEAR" and a 1000 TORR CDG is connected to the VGC083. The VGC083 CG2/ALT display channel is registering a pressure reading of 7.60E02 Torr. For a 1000 TORR CDG with a 0-10 VDC output, the expected analog output at 760 Torr is 7.60 volts. Use the UP or DOWN keys in the AOUT CAL 1 screen to set the analog output to 7.60 V as recorded by your voltmeter. Alternatively, if the alternate gauge analog output is used to display the pressure on your PLC or system display console, simply adjust the AOUT CAL 1 while the gauge is exposed to atmosphere so that the alternate gauge atmospheric pressure displayed by your PLC matches the atmospheric pressure displayed by the CG2/ALT display channel of the VGC083.

For other CDG ranges always use CDG's full scale pressure value to perform calibration. For example, if you are using a 100 TORR CDG, evacuate your system pressure to 100 Torr and use the same calibration procedure described above.

Note - As you adjust the analog output, the number being displayed in the AOUT CAL 1 screen represents the millivolts offset from zero volts that is being used internally for the analog output gain adjustment.

AOUT CAL 2 [Factory default = Factory Set]
 (Same info as AOUT CAL 1 above, except for AOUT CAL 2)

AOUT CAL 3 [Factory default = Factory Set]
 (Same info as AOUT CAL 1 above, except for AOUT CAL 3)

AOUT LIN 1 [Factory default = 1.00E00 TORR]
 This programming parameter is only used if you have assigned IG LINEAR, CG1 LINEAR or CG2 LINEAR to ANALOG OUTPUT 1 above. This analog output type provides a 0-10 Vdc output signal that has a direct linear relationship to the displayed pressure measured by the IG, CG1 or CG2. The AOUT LIN 1 value programmed here represents the maximum pressure as measured by the IG, CG1 or CG2 corresponding to a voltage output of 10 volts. This selection covers, at most, a 3 decade range of pressure.
 For example, if AOUT LIN 1 is programmed for 1.00E-03 Torr, then the instrument provides a 10 volt analog output signal when pressure is at 1.00E-03 Torr. Thereafter, minimum pressure is automatically set to 1.00E-06 Torr, with a corresponding minimum voltage output of 0.01 volts. If your application requires the IG, CG1 or CG2 analog output voltage to cover a pressure range exceeding three decades, then consider using the log-linear analog outputs. Refer to section 7.6 and section 7.10 for details regarding this type of output signal.

AOUT LIN 2 [Factory default = 1.00E00 TORR]
 (Same info as AOUT LIN 1 above, except for AOUT LIN 2)

AOUT LIN 3 [Factory default = 1.00E00 TORR]
 (Same info as AOUT LIN 1 above, except for AOUT LIN 3)

6.5.6 SERIAL COMM

The VGC083 provides both RS232 and RS485 serial communications. Press the ENTER key to access the SERIAL COMM menu for configuring the serial communications.

COMM TYPE

[Factory default = RS485]

The VGC083 supports six different protocols listed below (See section 9 for details).

- RS485 RS485 with start and stop characters and address, derived from INFICON BAG302
- RS232 RS232 with start and stop characters, like RS485 above but no address
- GP485 RS485 compatible with Granville-Phillips 307 and 358 controllers
- GP232 RS232 compatible with Granville-Phillips 307 and 358 controllers
- 2GP485 RS485 compatible with Granville-Phillips 350 controller
- 2GP232 RS232 compatible with Granville-Phillips 350 controllers

BAUDRATE

[Factory default = 19200]

This sets the baud rate for the RS485 and the RS232 serial communications. The baud rate can be set to various values listed below.

- 38400 BAUD
- 19200 BAUD
- 9600 BAUD
- 4800 BAUD
- 2400 BAUD
- 1200 BAUD
- 600 BAUD
- 300 BAUD

FRAMING

[Factory default = 8 BITS, NONE 1]

This sets the character framing by providing the user various selections to control the number of characters, parity and number of stop bits. Character framing can be set to one of the following.

- 8 BITS NONE 1 (This selection sets the character framing to 8 data bits, no parity, 1 stop bit)
- 7 BITS ODD 2
- 7 BITS EVEN 2
- 7 BITS ODD 1
- 7 BITS EVEN 1
- 8 BITS ODD 1
- 8 BITS EVEN 1

ADDRESS

[Factory default = 01]

This sets the two byte RS485 device address. For example, an ADDRESS of 05 will make the address 0x05 in hexadecimal. An address of 15 will set the ADDRESS to 0x15 in hexadecimal.

6.5.7 DISPLAY

The DISPLAY menu allows the user to configure the OLED setup screen. The user can configure the set-up screen to normal or research mode for IG, enable or disable screen saver and adjust the display intensity. Press the ENTER key to access the DISPLAY menu for configuring the setup screen.

SCREEN SETUP

[Factory default = NORMAL]

This menu configures the display mode for the setup screen. The setup screen can be configured to display the IG parameters in NORMAL or RESEARCH mode. Use the UP and DOWN keys to select the desired setup screen mode from the following menu choices.

- NORMAL Normal display mode for IG
- RESEARCH Research display mode for IG

Select "NORMAL" if you would like to configure the setup screen to display the IG parameters in the normal mode shown below.

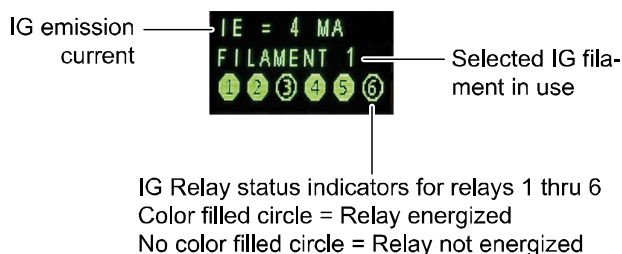

Select "RESEARCH" if you would like to configure the setup screen to display the IG parameters in the research mode shown below. This is particularly helpful when troubleshooting IG issues.

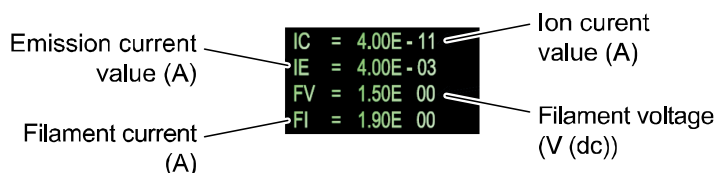

SCREEN SAVER

[Factory default = ON]

The VGC083 set-up screen uses an OLED type display which over an extended period of time can start to show divergence between pixels that are on at all times versus pixels that are not. This could result in pixels exhibiting a burned-in effect. To minimize the burned-in effect, a screen saver function can be activated by programming the SCREEN SAVER menu selection to ON. With the screen saver function turned on, the setup screen changes display appearance every 12 hours. The display will appear in the normal mode with a dark background color for the first 12 hours and will then switch to a back-lit background color for the next 12 hours. If you like to have the 12 hour period for the normal display mode to start at a specific time of the day, simply access the SCREEN SAVER menu and change setting to OFF and then ON again. This initiates the screen saver function immediately.

NOTE To increase longevity of the OLED display, INFICON recommends that the screen saver function remains ON as shipped from the factory.

BRIGHTNESS

[Factory default = 0]

The BRIGHTNESS menu allows the user to select the brightness of the setup screen display. The brightness setting of 0 provides the lowest brightness (contrast) and 10 the highest.

NOTE To increase longevity of the OLED display, INFICON recommends that the brightness function remains at 0 as shipped from the factory.

LED BRIGHTNESS

[Factory default = 8]

Depending on the age of your controller this LED BRIGHTNESS menu may not be available in your product. The LED BRIGHTNESS menu allows the user to select the brightness of the three channel pressure measurement LED displays. The brightness setting of 0 provides the lowest brightness (contrast) and 10 the highest.

7 Analog Output Charts & Equations (Nitrogen/Air Only)

This section provides various charts & equations for analog outputs available from the VGC083.

7.1 Analog Output wide range measurement for IG - CG1 0.5 - 7V (Nitrogen / Air only)

When the analog output is setup, as described in section 6.5.6 for IG - CG1/CG2/ALT 0.5-7V, the analog output voltage represents a combination of the IG and CG1 or IG and CG2 or IG and ALT gauge for wide range measurements. Refer to section 8.3.2 if you are using a gas other than nitrogen/air.

Analog output: Wide Range Log-linear 0.5 to 7 V (dc), 0.5 V per decade

A) The log-linear output signal and pressure are related by the following formulas when units of measurement is in Torr and mbar:

$$P = 10^{(\text{volts} - 5.5)/(0.5)} \quad V = ((0.5 \times \log_{10}(P)) + 5.5)$$

Where P is the pressure in Torr or mbar, and V is the output signal in volts.

B) The log-linear output signal and pressure are related by the following formulas when units of measurement is in pascals:

$$P = 10^{(\text{volts} - 4.5)/(0.5)} \quad V = ((0.5 \times \log_{10}(P)) + 4.5)$$

Where P is the pressure in pascals, and V is the output signal in volts.

Pressure [Torr]	Voltage [V (dc)]
1.00E-10	0.5
1.00E-9	1.0
1.00E-8	1.5
1.00E-7	2.0
1.00E-6	2.5
1.00E-5	3.0
1.00E-4	3.5
1.00E-3	4.0
1.00E-2	4.5
1.00E-1	5.0
1.00E+00	5.5
1.00E+01	6.0
1.00E+02	6.5
1.00E+03	7.0
see notes	≥11

Notes: The output voltage will switch to above +11 V (dc) under the following conditions:

- 1) The IG sensor is turned off, any IG fault condition and the CG1 is damaged or disconnected.
- 2) The pressure exceeds 1.00×10^{-3} Torr at 100 μ A emission current, 5.00×10^{-4} Torr at 4 mA emission current, 1.00×10^{-4} Torr at 10 mA emission current for BAG05x series ion gauges and CG1 is damaged or disconnected.
- 3) Any IG or CG faults condition while operating in the IG or CG range respectively.

The following chart shows the graphical results of table and formulas above for pressure measurements in Torr. Pressure is plotted on the X-axis with a log scale; the output signal is plotted on the Y-axis on a linear scale.

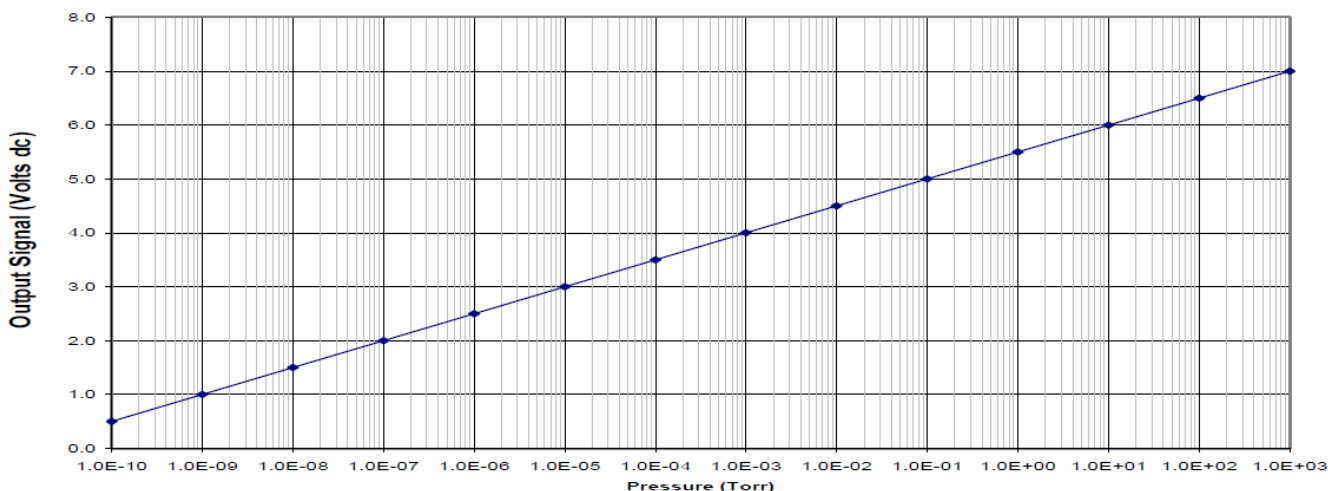

7.2 Analog Output for IG LOG N - 10 (Nitrogen / Air only)

When the analog output is setup, as described in section 6.5.6 for IG LOG N - 10, the analog output voltage represents the pressured measured by the IG for nitrogen/air only. Refer to section 8.3.1 if you are using a gas other than nitrogen/air.

Analog output: IG Log-linear 0 to 9 V (dc), 1 V per decade

A) The log-linear output signal and pressure are related by the following formulas when units of measurement is in Torr and mbar:

$$P = 10^{(\text{volts} - 10)} \quad V = \log_{10}(P) + 10$$

Where P is the pressure in Torr or mbar, and V is the output signal in volts.

B) The log-linear output signal and pressure are related by the following formulas when units of measurement is in pascals:

$$P = 10^{(\text{volts} - 8)} \quad V = \log_{10}(P) + 8$$

Where P is the pressure in pascals, and V is the output signal in volts.

Pressure [Torr]	Voltage [V (dc)]
1.00E-10	0.0
1.00E-9	1.0
1.00E-8	2.0
1.00E-7	3.0
1.00E-6	4.0
1.00E-5	5.0
1.00E-4	6.0
1.00E-3	7.0
1.00E-2	8.0
5.00E-2	8.698
see notes	≥11

Notes: The output voltage will switch to above +11 V (dc) under the following conditions:

- 1) The IG sensor is turned off or any IG fault condition.
- 2) The pressure exceeds 1.00×10^{-3} Torr at 100 μ A emission current, 5.00×10^{-4} Torr at 4 mA emission current, 1.00×10^{-4} Torr at 10 mA emission current for BAG05x series ion gauges.

The following chart shows the graphical results of table and formulas above for measurements in Torr. Pressure is plotted on the X-axis with a log scale; the output signal is plotted on the Y-axis on a linear scale.

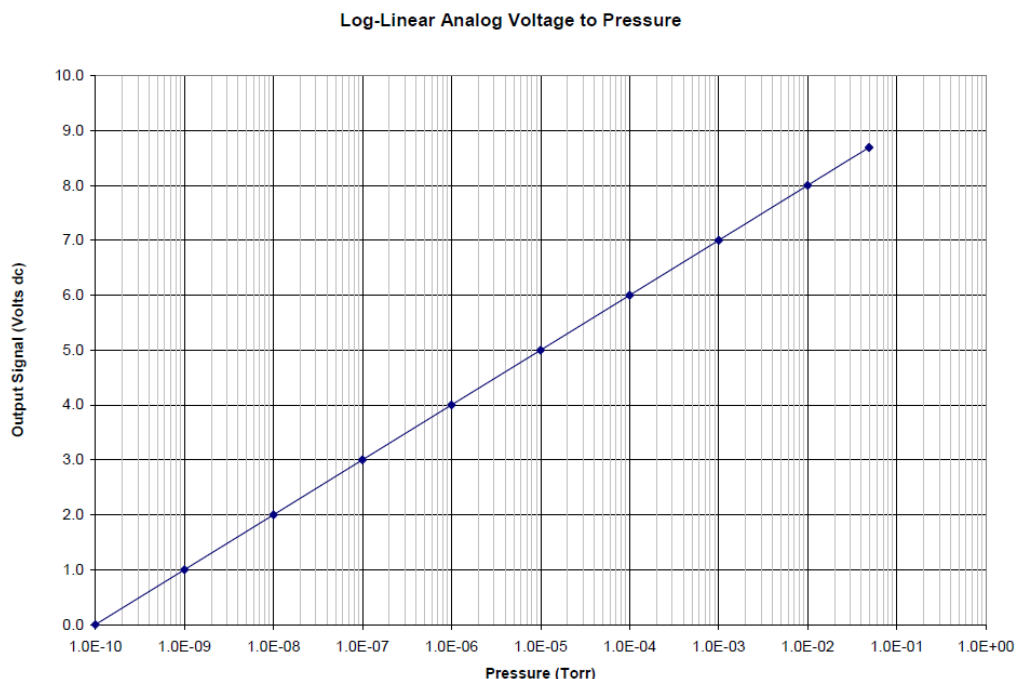

7.3 Analog Output for IG LOG N - 11 (Nitrogen / Air only)

When the analog output is setup, as described in section 6.5.6 for IG LOG N - 11, the analog output voltage represents the pressured measured by the IG for nitrogen/air only. Refer to section 8.3.1 if you are using a gas other than nitrogen/air.

Analog output: IG Log-linear 0 to 10 V (dc), 1 V per decade

A) The log-linear output signal and pressure are related by the following formulas when units of measurement is in Torr and mbar:

$$P = 10^{(\text{volts} - 11)} \quad V = \log_{10}(P) + 11$$

Where P is the pressure in Torr or mbar, and V is the output signal in volts.

B) The log-linear output signal and pressure are related by the following formulas when units of measurement is in pascals:

$$P = 10^{(\text{volts} - 9)} \quad V = \log_{10}(P) + 9$$

Where P is the pressure in pascals, and V is the output signal in volts.

Notes: The output voltage will switch to above +11 V (dc) under the following conditions:

- 1) The IG sensor is turned off or any IG fault condition.
- 2) The pressure exceeds 1.00×10^{-3} Torr at 100 μ A emission current, 5.00×10^{-4} Torr at 4 mA emission current, 1.00×10^{-4} Torr at 10 mA emission current for BAG05x series ion gauges.

Pressure [Torr]	Voltage [V (dc)]
1.00E-11	0.0
1.00E-10	1.0
1.00E-9	2.0
1.00E-8	3.0
1.00E-7	4.0
1.00E-6	5.0
1.00E-5	6.0
1.00E-4	7.0
1.00E-3	8.0
1.00E-2	9.0
5.00E-2	9.698
see notes	≥11

The following chart shows the graphical results of table and formulas above for pressure measurements in Torr. Pressure is plotted on the X-axis with a log scale; the output signal is plotted on the Y-axis on a linear scale.

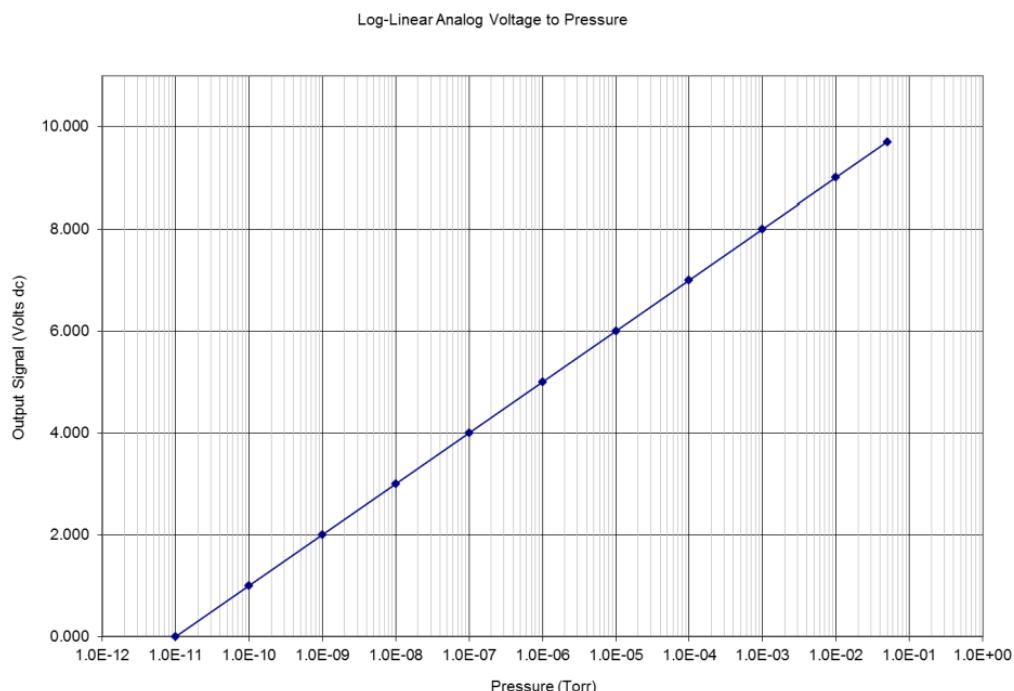

7.4 Analog Output for IG LOG N - 12 (Nitrogen / Air only)

When the analog output is setup, as described in section 6.5.6 for IG LOG N - 12, the analog output voltage represents the pressured measured by the IG for nitrogen/air only. Refer to section 8.3.1 if you are using a gas other than nitrogen/air.

Analog output: IG Log-linear 0 to 11 V (dc), 1 V per decade

A) The log-linear output signal and pressure are related by the following formulas when units of measurement is in Torr and mbar:

$$P = 10^{(\text{volts} - 12)} \quad V = \log_{10}(P) + 12$$

Where P is the pressure in Torr or mbar, and V is the output signal in volts.

B) The log-linear output signal and pressure are related by the following formulas when units of measurement is in pascals:

$$P = 10^{(\text{volts} - 10)} \quad V = \log_{10}(P) + 10$$

Where P is the pressure in pascals, and V is the output signal in volts.

Notes: The output voltage will switch to above +11 V (dc) under the following conditions:

- 1) The IG sensor is turned off or any IG fault condition.
- 2) The pressure exceeds 1.00×10^{-3} Torr at 100 μ A emission current, 5.00×10^{-4} Torr at 4 mA emission current, 1.00×10^{-4} Torr at 10 mA emission current for BAG05x series ion gauges.

Pressure [Torr]	Voltage [V (dc)]
1.00E-12	0.0
1.00E-11	1.0
1.00E-10	2.0
1.00E-9	3.0
1.00E-8	4.0
1.00E-7	5.0
1.00E-6	6.0
1.00E-5	7.0
1.00E-4	8.0
1.00E-3	9.0
1.00E-2	10.0
5.00E-2	10.698
see notes	≥11

The following chart shows the graphical results of table and formulas above for pressure measurements in Torr. Pressure is plotted on the X-axis with a log scale; the output signal is plotted on the Y-axis on a linear scale.

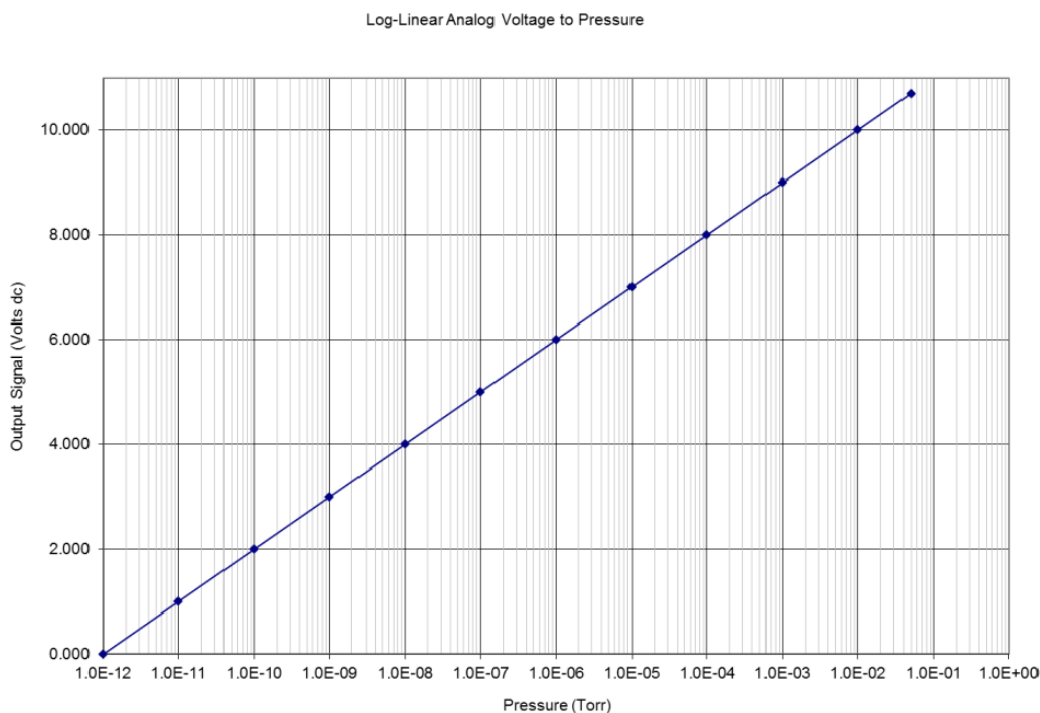

7.5 Analog Output for IG 1.8 - 8.7 V (Nitrogen / Air only)

When the analog output is setup, as described in section 6.5.6, for IG 1.8 – 8.7V, the analog output voltage represents the pressured measured by the IG for nitrogen/air only. Refer to section 8.3.1 if you are using a gas other than nitrogen/air.

Analog output: IG Log-linear 0 to 9.259 Vdc, 0.8 V per decade

The log-linear output signal and pressure are related by the following formulas:

$$P \text{ (Torr)} = 10^{((1.25 \times \text{volts}) - 12.875)} \quad V = 10.3 + (0.8) \times \log_{10}(P)$$

$$P \text{ (mbar)} = 10^{((1.25 \times \text{volts}) - 12.75)} \quad V = 10.2 + (0.8) \times \log_{10}(P)$$

$$P \text{ (pascals)} = 10^{((1.25 \times \text{volts}) - 10.75)} \quad V = 8.6 + (0.8) \times \log_{10}(P)$$

Where P is the pressure and V is the output signal in volts.

Notes: The output voltage will switch to above +11 V (dc) under the following conditions:

- 1) The IG sensor is turned off or any IG fault condition.
- 2) The pressure exceeds 1.00×10^{-3} Torr at 100 μ A emission current, 5.00×10^{-4} Torr at 4 mA emission current, 1.00×10^{-4} Torr at 10 mA emission current for BAG05x series ion gauges.

Pressure [Torr]	Voltage [V (dc)]
2.00E-11	1.741
4.20E-11	2.0
7.50E-10	3.0
1.30E-8	4.0
2.40E-7	5.0
4.20E-6	6.0
7.50E-5	7.0
1.30E-3	8.0
5.00E-2	9.698
filament is OFF	≥11

The following chart shows the graphical results of table and formulas above for pressure measurements in Torr. Pressure is plotted on the X-axis with a log scale; the output signal is plotted on the Y-axis on a linear scale.

Log-Linear Analog Voltage to Pressure

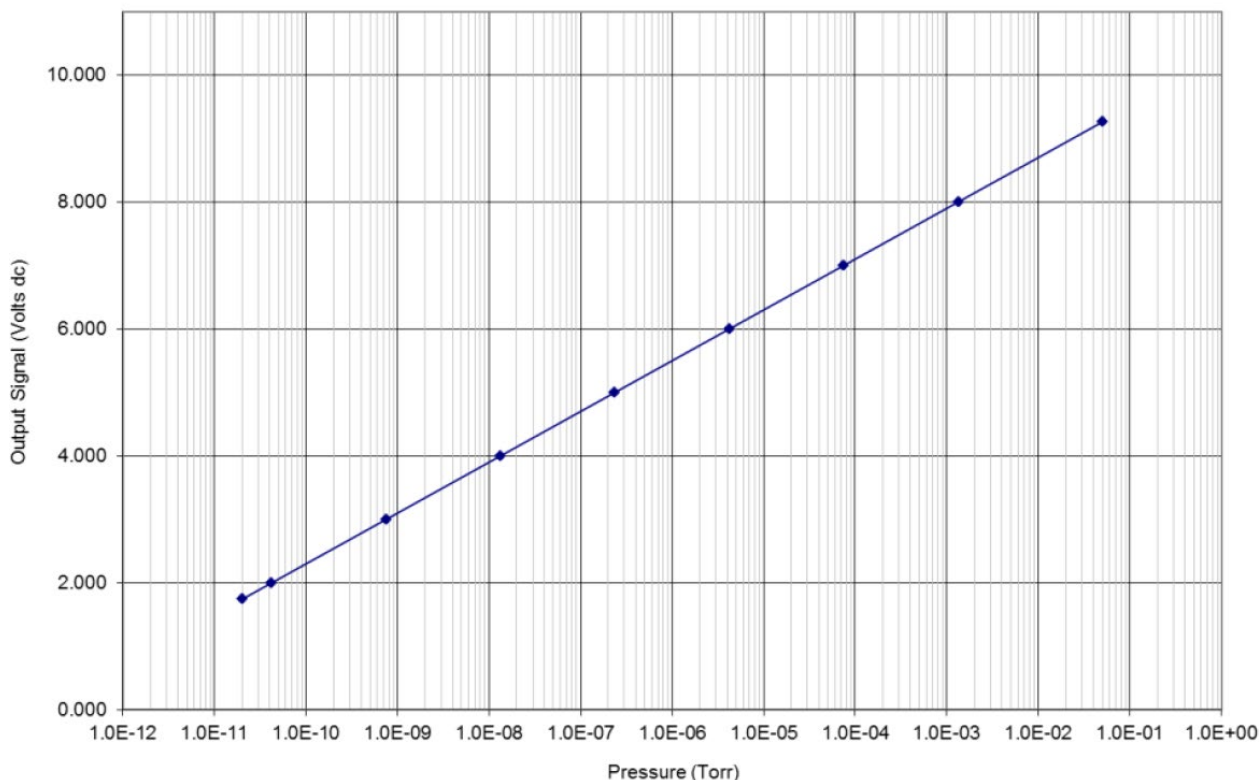

7.6 Analog Output for IG LINEAR (Nitrogen / Air only)

When the analog output is setup, as described in section 6.5.6, for IG LINEAR, the analog output voltage represents the pressure measured by the IG for nitrogen/air only. The Linear analog output type provides a 0-10 V (dc) output signal that has a direct linear relationship to the displayed pressure measured by the ion gauge only. This selection covers 3 decades of pressure change. For example, if ANALOG OUT 1 is programmed for IG LINEAR and the maximum pressure for AOUT LIN 1 selected is 1.00E-03 Torr, then the instrument provides a 10 volt analog output signal when pressure as measured by IG is at 1.00E-03 Torr. Furthermore, the minimum pressure is automatically set to 1.00E-06 Torr, with a corresponding minimum voltage output of 0.01 volts.

Constructing a table of these parameters may be useful in documenting the relationship of displayed pressure (measured by the IG) to the analog output voltage. The following table is representative of a typical setup where the IG may be used in a limited range of pressure measurement where a direct linear relationship exists between the displayed pressure (mantissa) and the analog output signal.

Linear Analog Output Voltage - volts	Measured (Displayed) Pressure - Torr
0.01	1.00E-06
0.10	1.00E-05
1.00	1.00E-04
10.00	1.00E-03

If your application requires the analog output voltage to cover a pressure range exceeding three decades, then consider using a log-linear analog output type for the IG.

NOTE

The information discussed above regarding the Linear IG analog output applies only to N₂ / air. If you are using a gas other than N₂ / air, refer to section 8.3.1. Apply the Gas Correction Factor by dividing the pressure derived (from using the Linear IG output discussed above) by the specific Gas Correction Factor to obtain the true pressure of the specific gas in your vacuum chamber.

Notes: The output voltage will switch to above +11 V (dc) under the following conditions:

- 1) The IG sensor is turned off or any IG fault condition.
- 2) The pressure exceeds 1.00 × 10⁻³ Torr at 100 µA emission current, 5.00 × 10⁻⁴ Torr at 4 mA emission current, 1.00 × 10⁻⁴ Torr at 10 mA emission current for BAG05x series ion gauges.

7.7 Analog Output for CG1 or CG2 1 - 8 V (Nitrogen / Air only)

When the analog output is setup, as described in section 6.5.6, for CG1 1 – 8 V or CG2 1 – 8 V, the analog output voltage represents the pressure measured by CG1 or CG2 for nitrogen/air only. Refer to section 8.3.3.1 if you are using a gas other than nitrogen/air.

Analog output: Convection Gauge Log-linear 1 to 8 V (dc), 1 V per decade

A) The log-linear output signal and pressure are related by the following formulas when units of measurement is in Torr and mbar:

$$P = 10^{(\text{volts} - 5)} \quad V = \log_{10}(P) + 5$$

Where P is the pressure in Torr or mbar, and V is the output signal in volts.

The output voltage is 1 V when pressure is at 1.00E-04 Torr.

The output voltage is 8 V when pressure is at 1.00E+03 Torr.

B) The log-linear output signal and pressure are related by the following formulas when units of measurement is in pascals:

$$P = 10^{(\text{volts} - 3)} \quad V = \log_{10}(P) + 3$$

Where P is the pressure in pascals, and V is the output signal in volts.

Notes: An analog output of above +11 volts indicates a faulty convection gauge or unplugged gauge cable.

Pressure [Torr]	Voltage [V]	Pressure [Torr]	Voltage [V]	Pressure [Torr]	Voltage [V]
1.00E-04	1.000	2.00E-01	4.301	3.00E+02	7.477
2.00E-04	1.301	5.00E-01	4.699	4.00E+02	7.602
5.00E-04	1.699	1.00E+00	5.000	5.00E+02	7.699
1.00E-03	2.000	2.00E+00	5.301	6.00E+02	7.778
2.00E-03	2.301	5.00E+00	5.699	7.00E+02	7.845
5.00E-03	2.699	1.00E+01	6.000	7.60E+02	7.881
1.00E-02	3.000	2.00E+01	6.301	8.00E+02	7.903
2.00E-02	3.301	5.00E+01	6.699	9.00E+02	7.954
5.00E-02	3.699	1.00E+02	7.000	1.00E+03	8.000
1.00E-01	4.000	2.00E+02	7.301		

The following chart shows the graphical results of table and formulas above for pressure measurements in Torr.

Log-Linear Analog Voltage to Pressure

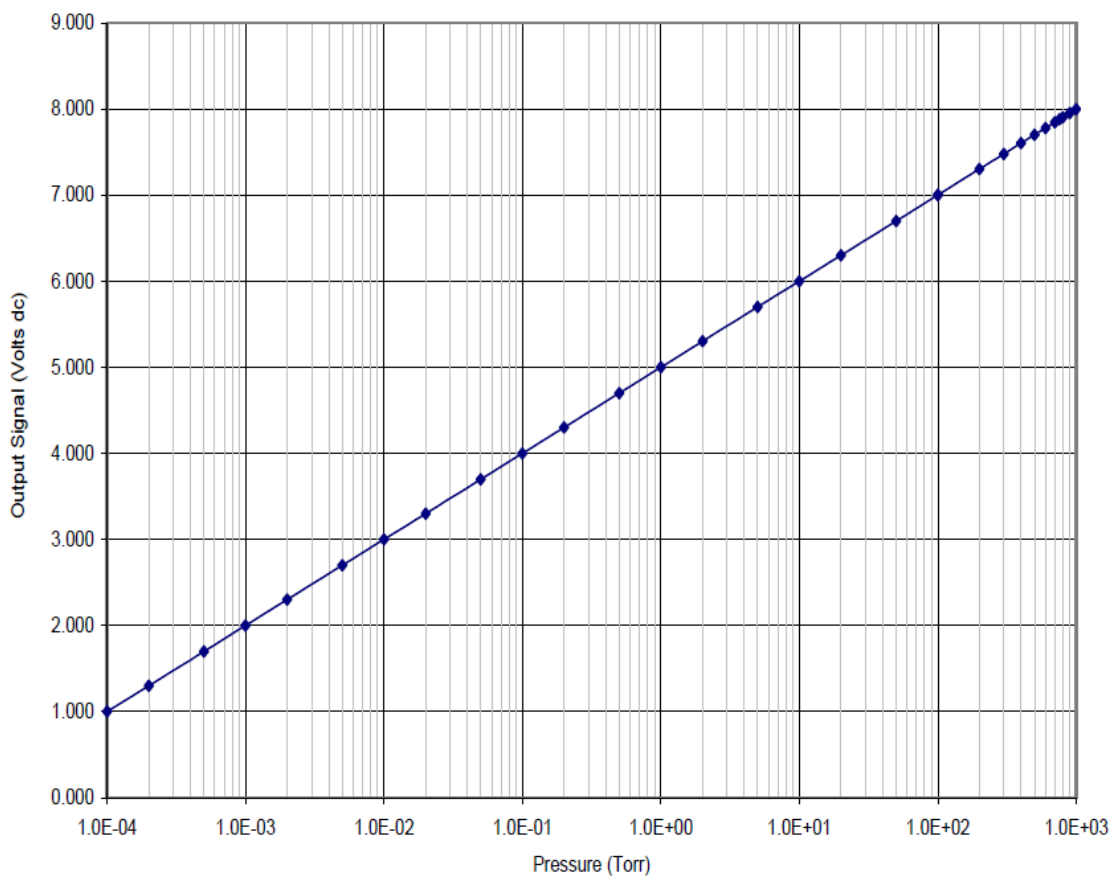

7.8 Analog Output for CG1 or CG2 0 - 7 V (Nitrogen / Air only)

When the analog output is setup, as described in section 6.5.6, for CG1 0 – 7 V or CG2 0 – 7 V, the analog output voltage represents the pressure measured by CG1 or CG2 for nitrogen/air only. Refer to section 8.3.3.2 if you are using a gas other than nitrogen/air.

Analog output: Convection Gauge Log-linear 0 to 7 V (dc), 1 V per decade

A) The log-linear output signal and pressure are related by the following formulas when units of measurement is in Torr and mbar:

$$P = 10^{(\text{volts} - 4)} \quad V = \log_{10}(P) + 4$$

Where P is the pressure in Torr or mbar, and V is the output signal in volts.

The output voltage is 0 V when pressure is at 1.00E-04 Torr.

The output voltage is 7 V when pressure is at 1.00E+03 Torr.

B) The log-linear output signal and pressure are related by the following formulas when units of measurement is in pascals:

$$P = 10^{(\text{volts} - 2)} \quad V = \log_{10}(P) + 2$$

Where P is the pressure in pascals, and V is the output signal in volts.

Notes: An analog output of above +11 volts indicates a faulty convection gauge or unplugged gauge cable.

Pressure [Torr]	Voltage [V]	Pressure [Torr]	Voltage [V]	Pressure [Torr]	Voltage [V]
1.00E-04	0.000	2.00E-01	3.300	3.00E+02	6.480
2.00E-04	0.301	5.00E-01	3.700	4.00E+02	6.600
5.00E-04	0.699	1.00E+00	4.000	5.00E+02	6.700
1.00E-03	1.000	2.00E+00	4.300	6.00E+02	6.780
2.00E-03	1.300	5.00E+00	4.700	7.00E+02	6.850
5.00E-03	1.700	1.00E+01	5.000	7.60E+02	6.880
1.00E-02	2.000	2.00E+01	5.300	8.00E+02	6.900
2.00E-02	2.300	5.00E+01	5.700	9.00E+02	6.950
5.00E-02	2.700	1.00E+02	6.000	1.00E+03	7.000
1.00E-01	3.000	2.00E+02	6.300		

The following chart shows the graphical results of table and formulas above for measurements in Torr.

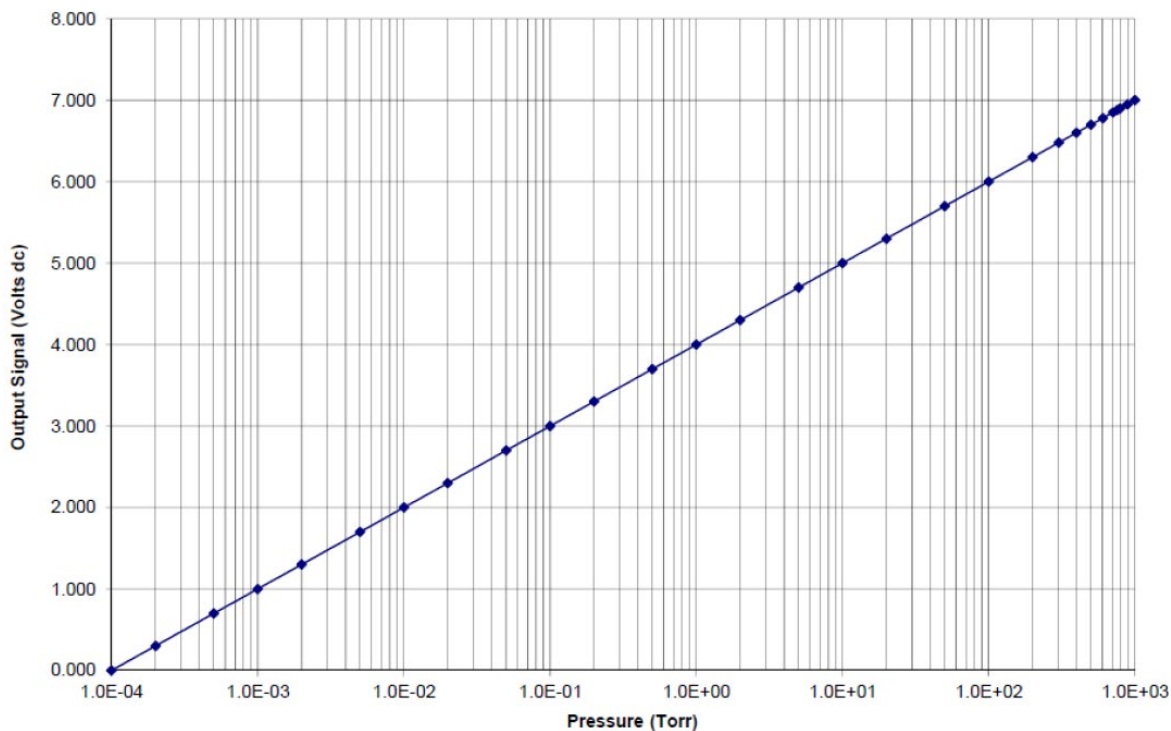

7.9 Analog Output for CG1 or CG2 NON - LIN (Nitrogen / Air only)

When the analog output is setup, as described in section 6.5.6, for CG1 NON - LIN or CG2 NON - LIN, the analog output voltage represents the pressure measured by CG1 or CG2 for nitrogen/air only. Refer to section 8.3.3.3 if you are using a gas other than nitrogen/air.

The first convection enhanced pirani head introduced was the Convector®. The controller for the Convector® provided an analog output signal referred to as the "S-curve" which represented the actual voltage applied across the head circuit, proportional to the pressure inside the pressure head enclosure. The Granville-Phillips® Convector® controllers were designed to output this head voltage and in later years, the non-linear voltage applied to the head was scaled to provide various signal spans of the original "S-curve". The non-linear analog output of the VGC083 duplicates the original S-curve of 0.375 volts at pressure less than 1.00×10^{-4} Torr to 5.659 volts at 1000 Torr, nitrogen or air.

In general, one may use linear interpolation techniques to calculate the pressure using the non-linear analog output voltage measured at a specific pressure. You may also calculate the N₂/air pressure represented by the non-linear analog output voltage for the original "S-curve" using a multi-segment, nth order polynomial function calculation listed on the following page.

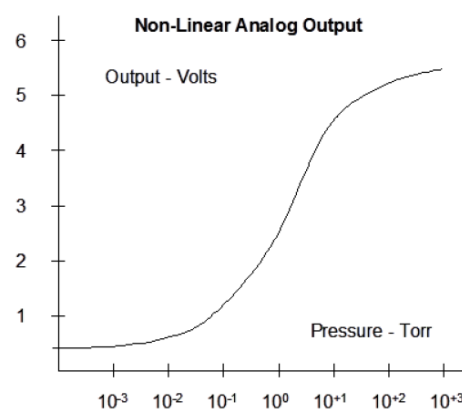

Pressure [Torr]	Voltage [V]	Pressure [Torr]	Voltage [V]	Pressure [Torr]	Voltage [V]
0.000	0.3751	1.00E-01	0.8780	2.00E+02	5.0190
1.00E-04	0.3759	2.00E-01	1.1552	3.00E+02	5.1111
2.00E-04	0.3768	5.00E-01	1.6833	4.00E+02	5.2236
5.00E-04	0.3795	1.00E+00	2.2168	5.00E+02	5.3294
1.00E-03	0.3840	2.00E+00	2.8418	6.00E+02	5.4194
2.00E-03	0.3927	5.00E+00	3.6753	7.00E+02	5.4949
5.00E-03	0.4174	1.00E+01	4.2056	7.60E+02	5.5340
1.00E-02	0.4555	2.00E+01	4.5766	8.00E+02	5.5581
2.00E-02	0.5226	5.00E+01	4.8464	9.00E+02	5.6141
5.00E-02	0.6819	1.00E+02	4.9449	1.00E+03	5.6593

Note - An analog output of above +11 volts indicates a faulty convection gauge or unplugged gauge cable.

The equations and coefficients for the nth order polynomial equation defined for various pressure measurement ranges for the Non-linear analog output (S-curve) for CG1 or CG2 for N₂/air described above are given in the following table:

For **0 mTorr to about 2 Torr**, the Non-Linear Analog Output voltage range of **0.375 to 2.842 volts**, use this table.

Coefficients for $y(x) = a + bx + cx^2 + dx^3 + ex^4 + fx^5$	
a	-0.02585
b	0.03767
c	0.04563
d	0.1151
e	-0.04158
f	0.008738

For **2 Torr to about 100 Torr**, the Non-Linear Analog Output voltage range of **2.842 to 4.945 volts**, use this table.

Coefficients for $y(x) = \frac{a+cx+ex^2}{1+bx+dx^2+fx^3}$	
a	0.1031
b	-0.3986
c	-0.02322
d	0.07438
e	0.07229
f	-0.006866

For **100 Torr to 1000 Torr**, the Non-Linear Analog Output voltage range of **4.94 to 5.659 volts**, use this table.

Coefficients for $y(x) = \frac{a+cx}{1+bx+dx^2}$	
a	100.624
b	-0.37679
c	-20.5623
d	0.0348656

Where $y(x)$ = pressure in Torr, x = measured analog output in volts

Example: Measured analog output voltage is 0.3840 V.

From first table shown above use equation:

$$y(x) = a + bx + cx^2 + dx^3 + ex^4 + fx^5$$

$$x = 0.3840 \text{ volts}$$

$$a = -0.02585, \quad b = 0.03767, \quad c = 0.04563, \quad d = 0.1151, \quad e = -0.04158, \quad f = 0.008738$$

$$y(x) = \text{Pressure} = 1.0\text{E-}03 \text{ Torr}$$

7.10 Analog Output for CG1 or CG2 LINEAR (Nitrogen / Air only)

When the analog output is setup, as described in section 6.5.6 , for CG1 LINEAR or CG2 LINEAR, the analog output voltage represents the pressure measured by the CG1 or CG2 for nitrogen/air only. The Linear analog output type provides a 0-10 V (dc) output signal that has a direct linear relationship to the displayed pressure measured by the CG1 or CG2 only. This selection covers 3 decades of pressure change. For example, if ANALOG OUT 1 is programmed for CG1 LINEAR and the maximum pressure for AOUT LIN 1 selected is 1.00 Torr, then the instrument provides a 10 volt analog output signal when pressure as measured by CG1 is at 1.00 Torr. Furthermore, the minimum pressure is automatically set to 1.00E-03 Torr, with a corresponding minimum voltage output of 0.01 volts.

Constructing a table of these parameters may be useful in documenting the relationship of displayed pressure (measured by the IG) to the analog output voltage. The following table is representative of a typical setup where the CG may be used in a limited range of pressure measurement where a direct linear relationship exists between the displayed pressure (mantissa) and the analog output signal.

Linear Analog Output Voltage - volts	Measured (Displayed) Pressure - Torr
0.01	1.00E-03
0.10	1.00E-02
1.00	1.00E-01
10.00	1.00E+00

If your application requires the analog output voltage to cover a pressure range exceeding three decades, then consider using a log-linear analog output type for CG1 or CG2.

Note - An analog output of above +11 volts indicates a faulty convection gauge or unplugged gauge cable.

8 Using the Gauge with Different Gases

The following tables and explanation contain important information regarding the use of ionization and convection gauges when used to measure pressure of gases other than nitrogen /air. For both types of gauge heads, corrections must be applied to both the display and analog outputs. This is particularly critical when using convection gauges at higher pressures than measured by the ion gauge when using gases other than N₂/air.

8.1 Ion Gauge Display Correction Factors for Selected Gases

There are two methods that can be used for monitoring the IG display when using gases other than nitrogen/air:

1) If you are using a gas other than N₂ / air, you must manually apply a gas correction factor to the IG displayed measurement. Post a label on your ion gauge display showing the correction factor to be used for the pressure of the gas type you are measuring. The table below provides typical correction factors for ion gauges when used with gas types other than N₂ / air. To correct the display measurements, divide the displayed measured pressure by the correction factor for the gas type you are measuring:

Ion Gauge Gas Correction Factors for selected gases

Gas	Gas CorrectionFactor	Gas	Gas Correction Factor
He	0.18	H ₂ O	1.12
Ne	0.30	NO	1.16
D ₂	0.35	Ar	1.29
H ₂	0.46	CO ₂	1.42
N ₂	1.00	Kr	1.94
Air	1.00	SF ₆	2.50
O ₂	1.01	Xe	2.87
CO	1.05	Hg	3.64

For example, if the gas in use is argon (Ar) and the ion gauge measured pressure is displayed as 4.00×10^{-7} Torr, the actual, true pressure of argon is then determined by the following equation:

$$\frac{4.00 \times 10^{-7}}{1.29} \text{ Torr} = 3.10 \times 10^{-7} \text{ Torr, Ar}$$

2) Alternatively, you may correct the display for a direct reading of pressure for the type of gas you are using by adjusting the sensitivity factor for the IG. If you adjust the sensitivity factor for your ion gauge to compensate the readout of pressure for a gas type other than nitrogen / air, the displayed pressure readout for that device must be annotated to indicate that the displayed pressure is for the gas type the readout is compensated for.

In the above example, if the N₂ sensitivity of the ion gauge being used is 10 Torr⁻¹ ("10 per Torr"), the sensitivity factor programmed during setup of the VGC083 could be set for 12.9 (~13) so that the pressure readout would directly indicate the true pressure of argon. Again, the display line for that particular device pressure readout would require annotation (a user applied label) so as to not conflict with the gas type selection/notation of nitrogen (N₂).

8.2 Effects of Different Gases on Convection Gauge Display

Convection gauge operation is based on the physical effect of thermal conductivity of the gas inside the gauge head. The convection gauge senses heat loss in a sensor wire. This heat loss depends on the thermal conductivity of the gas surrounding the sensor wire. Since different gases, and mixtures, have different thermal conductivities, the indicated pressure readings and outputs will also be different. INFICON convection gauges (and most other thermal, heat loss type gauges) are normally calibrated using nitrogen. When a gas other than N_2 is used, correction must be made for the difference in thermal conductivity between N_2 and the gas in use. The charts and tables below indicate how different gases affect the display from an INFICON convection gauge.

For nitrogen gas (N_2) the calibration of the convection gauge shows excellent agreement between indicated and true pressure throughout the range from 10^{-4} to 1000 Torr. At pressures below about 1 Torr, the calibration curves for the different gases are similar. The difference in readings (between indicated and true pressure) at these low pressures is usually a constant; a function of the difference between thermal conductivities of the gases.

At pressures above about 1 Torr, indicated pressure readings may diverge significantly from true pressure. At these higher pressures, convection currents in the gauge become the predominant cause of heat loss from the sensor. Calibration and performance at pressures higher than about 1 Torr depends on gauge tube geometry and mounting orientation as well as gas properties.

Generally, air and N_2 are considered the same as far as thermal conductivity goes, but even these two gases will exhibit slight differences in readings at higher pressures. For example, when venting a system to atmosphere using N_2 , you may see readings change by about 30 to 40 Torr after the chamber is opened and air gradually displaces the N_2 in the gauge. This is due to the partial pressure of oxygen (O_2) contained in atmospheric air.

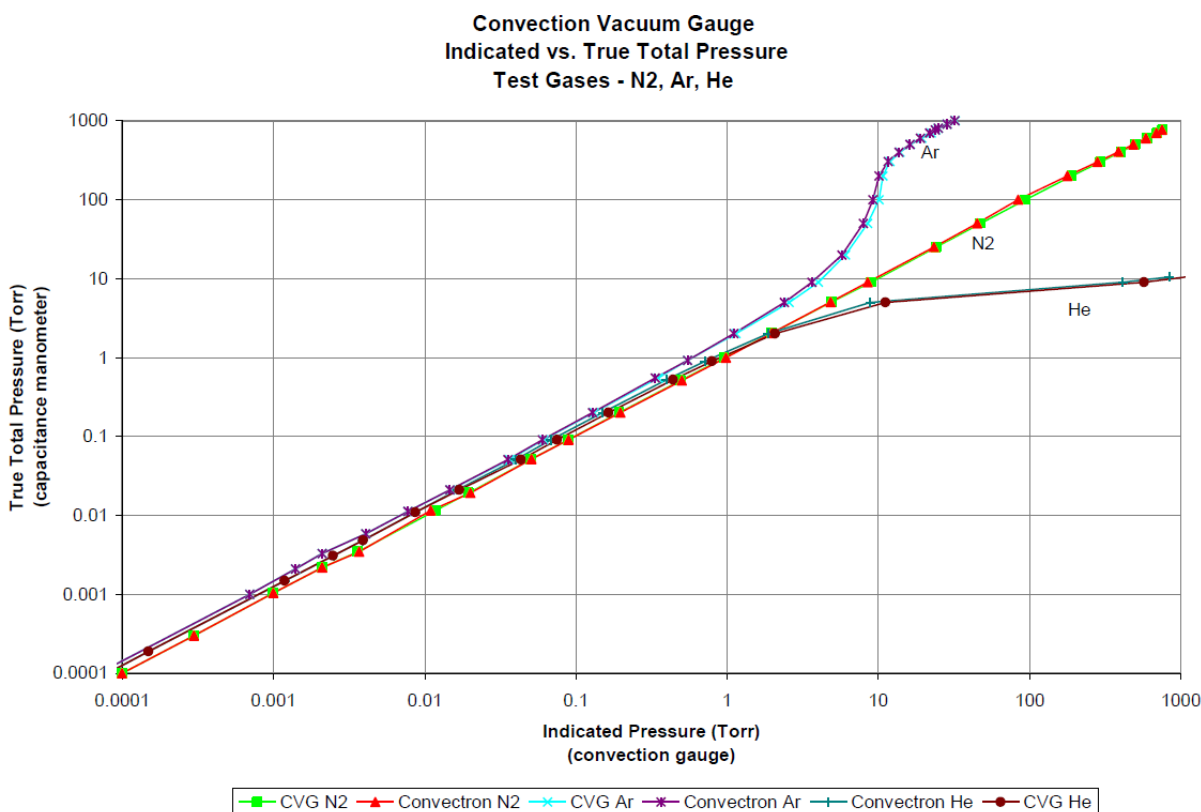

The Y-axis of the above chart is actual pressure as measured by a capacitance manometer, a diaphragm gauge that measures true total pressure independent of gas composition. The X-axis is the pressure reading indicated by the convection gauge under test. This chart shows readings for an INFICON convection gauge (CVG) and Granville-Phillips® Convector® gauge to illustrate that the difference in the response for both of these types of gauges is virtually indistinguishable.

CAUTION! Do not assume this data applies to other convection gauges which may or may not be the same. See Table 1 below and note the following examples:

Example A: If the gas is nitrogen (N₂), when the true total pressure is 500 Torr, the gauge will read 500 Torr.

Example B: If the gas is argon (Ar), when the true pressure is 100 Torr, the gauge will read about 9 Torr.

If you are backfilling your vacuum system with Ar, when your system reaches a pressure of 760 Torr true pressure your gauge will be reading about 23 Torr. Continuing to backfill your system, attempting to increase the reading up to 760 Torr, you will over pressurize your chamber which may present a hazard.

Example C: If the gas is helium (He), the gauge will read 1.10E+03 (overpressure indication) Torr when pressure reaches about 10 Torr true pressure and opening the chamber to atmosphere prematurely may present other hazards for both people and product. You probably will not cause damage to your vacuum system, but opening the chamber to atmosphere with the internal chamber pressure at only 10 Torr true pressure, may present other hazards for both personnel in the proximity and product that may be inside the chamber/vessel.

CAUTION! What these examples illustrate is that using gases other than nitrogen (N₂) without using accurate gas conversion data and other proper precautions could result in injury to personnel and/or damage to equipment.

Suggested precautions when using gases other than N₂:

- Install a pressure relief valve or burst disk on your chamber to provide protection from the dangers associated with over pressurizing the chamber.
- Post a warning label on your gauge readout such as "Do Not Exceed _____ Torr Indicated Pressure" (fill in the blank for the gas type you are using) so that an operator using the vacuum chamber system and connected gauge will not exceed a safe operating pressure.

CAUTION!  Do not assume this data applies to other convection gauges, which may or may not be the same.

CAUTION!  Risk of over pressurizing a gas containment vessel and attached apparatus exists when using pressure measurement devices that are calibrated for a specific gas type. Use a pressure relief device to safely limit the internal pressure of a containment vessel to less than the maximum allowable working pressure rating for the vacuum/pressure system and all devices attached to the system.

WARNING!  Using a thermal conductivity gauge with gases other than that for which it is calibrated could result in death or serious injury. Be sure to use gas correction data in this manual when measuring pressures of gases other than N₂ / air.

Exercise caution when admitting positive pressures (above local ambient, atmospheric pressure) of gas into any enclosed volume. Install pressure relief devices on your vacuum / pressure vessel or chamber to limit the maximum allowable working pressure inside the devices and vessel internal volume to less than the lowest rated device - in some cases, the maximum allowable working pressure may be dictated by the type of connections or fittings used to attach devices to your chamber. An O-ring compression fitting type device may be forcibly released (ejected) from the fitting if internal pressure exceeds the local barometric, ambient pressure.

The table below shows the convection gauge displayed readings at various pressures for several commonly used gas types:

True Pressure (Torr)	N ₂	Ar	He	O ₂	CO ₂	Kr	Freon12	Freon22	D ₂	Ne	CH ₄
1.00E-4	1.00E-4	1.00E-4	1.00E-4	1.00E-4	1.00E-4	1.00E-4	1.00E-4	1.00E-4	1.00E-4	1.00E-4	1.00E-4
2.00E-4	2.00E-4	2.00E-4	2.00E-4	2.00E-4	2.00E-4	2.00E-4	2.00E-4	2.00E-4	2.00E-4	2.00E-4	2.00E-4
5.00E-4	5.00E-4	5.00E-4	5.00E-4	5.00E-4	5.00E-4	3.00E-4	5.00E-4	5.00E-4	5.00E-4	5.00E-4	5.00E-4
1.00E-3	1.00E-3	7.00E-4	8.00E-4	1.00E-3	1.10E-3	4.00E-4	1.50E-3	1.50E-3	1.30E-3	7.00E-4	1.70E-3
2.00E-3	2.00E-3	1.40E-3	1.60E-3	2.00E-3	2.30E-3	1.00E-3	3.10E-3	3.10E-3	2.40E-3	1.50E-3	3.30E-3
5.00E-3	5.00E-3	3.30E-3	4.00E-3	5.00E-3	4.40E-3	2.30E-3	7.60E-3	7.00E-3	6.00E-3	3.50E-3	7.70E-3
1.00E-2	1.00E-2	6.60E-3	8.10E-3	9.70E-3	1.10E-2	4.80E-3	1.47E-2	1.35E-2	1.21E-2	7.10E-3	1.53E-2
2.00E-2	2.00E-2	1.31E-2	1.61E-2	1.98E-2	2.22E-2	9.50E-3	2.99E-2	2.72E-2	2.43E-2	1.41E-2	3.04E-2
5.00E-2	5.00E-2	3.24E-2	4.05E-2	4.92E-2	5.49E-2	2.35E-2	7.25E-2	6.90E-2	6.00E-2	3.48E-2	7.72E-2
1.00E-1	1.00E-1	6.43E-2	8.20E-2	9.72E-2	1.07E-1	4.68E-2	1.43E-1	1.36E-1	1.21E-1	7.00E-2	1.59E-1
2.00E-1	2.00E-1	1.26E-1	1.65E-1	1.94E-1	2.10E-1	9.11E-2	2.75E-1	2.62E-1	2.50E-1	1.41E-1	3.15E-1
5.00E-1	5.00E-1	3.12E-1	4.35E-1	4.86E-1	4.89E-1	2.17E-1	6.11E-1	5.94E-1	6.87E-1	3.59E-1	7.81E-1
1.00E+0	1.00E+0	6.00E-1	9.40E-1	9.70E-1	9.50E-1	4.00E-1	1.05E+0	1.04E+0	1.55E+0	7.45E-1	1.60E+0
2.00E+0	2.00E+0	1.14E+0	2.22E+0	1.94E+0	1.71E+0	7.00E-1	1.62E+0	1.66E+0	4.13E+0	1.59E+0	3.33E+0
5.00E+0	5.00E+0	2.45E+0	1.35E+1	4.98E+0	3.34E+0	1.28E+0	2.45E+0	2.62E+0	2.46E+2	5.24E+0	7.53E+0
1.00E+1	1.00E+1	4.00E+0	OP	1.03E+1	4.97E+0	1.78E+0	2.96E+0	3.39E+0	OP	2.15E+1	2.79E+1
2.00E+1	2.00E+1	5.80E+0	OP	2.23E+1	6.59E+0	2.29E+0	3.32E+0	3.72E+0	OP	5.84E+2	3.55E+2
5.00E+1	5.00E+1	7.85E+0	OP	7.76E+1	8.22E+0	2.57E+0	3.79E+0	4.14E+0	OP	OP	8.42E+2
1.00E+2	1.00E+2	8.83E+0	OP	2.09E+2	9.25E+0	2.74E+0	4.68E+0	4.91E+0	OP	OP	OP
2.00E+2	2.00E+2	9.79E+0	OP	2.95E+2	1.23E+1	3.32E+0	5.99E+0	6.42E+0	OP	OP	OP
3.00E+2	3.00E+2	1.13E+1	OP	3.80E+2	1.69E+1	3.59E+0	6.89E+0	7.52E+0	OP	OP	OP
4.00E+2	4.00E+2	1.35E+1	OP	4.85E+2	2.24E+1	3.94E+0	7.63E+0	8.42E+0	OP	OP	OP
5.00E+2	5.00E+2	1.61E+1	OP	6.04E+2	2.87E+1	4.21E+0	8.28E+0	9.21E+0	OP	OP	OP
6.00E+2	6.00E+2	1.88E+1	OP	7.30E+2	3.64E+1	4.44E+0	8.86E+0	9.95E+0	OP	OP	OP
7.00E+2	7.00E+2	2.18E+1	OP	8.59E+2	4.61E+1	4.65E+0	9.42E+0	1.07E+1	OP	OP	OP
7.60E+2	7.60E+2	2.37E+1	OP	9.41E+2	5.39E+1	4.75E+0	9.76E+0	1.11E+1	OP	OP	OP
8.00E+2	8.00E+2	2.51E+1	OP	9.97E+2	5.94E+1	4.84E+0	9.95E+0	1.14E+1	OP	OP	OP
9.00E+2	9.00E+2	2.85E+1	OP	OP	7.95E+1	4.99E+0	1.05E+1	1.20E+1	OP	OP	OP
1.00E+3	1.00E+3	3.25E+1	OP	OP	1.11E+2	5.08E+0	1.11E+1	1.27E+1	OP	OP	OP

Values listed under each gas type are in Torr units
Over Pressure (OP)= 1.10E+03 Torr

When using gases other than nitrogen/air, you must use the above look-up table to determine the true pressures of selected gases as measured by convection gauges. For example, if the gas you are using in your vacuum system chamber is predominately argon (Ar), a displayed pressure of 1.14E+00 Torr means the actual true pressure of argon is 2.00E+00 Torr based on the conversion information provided in the above table.

Example: If the gas is argon (Ar), when the true pressure is 100 Torr, the gauge will read only about 9 Torr.

8.3 Effects of Different Gases on Analog Output

The following tables and explanation contains important information regarding the use of ionization and convection gauges on gases other than N₂ / Air. For both types of gauges, corrections must be applied to the analog outputs.

8.3.1 Ion Gauge Analog Output Correction Factors for Selected Gases

When using any of the analog outputs assigned to ion gauge only, use the following steps to convert the analog output to pressure: Ion gauge analog output correction factors for selected gases:

- A) Refer to section 7 and use the related equation to convert the voltage in your receiving instrument to pressure. This pressure value is based on nitrogen gas.
- B) Apply the Gas Correction Factor for the particular gas you are using to the pressure value obtained in step A. Use correction factors and example listed below:

Ion Gauge Gas Correction Factors for selected gases

Gas	Gas CorrectionFactor	Gas	Gas Correction Factor
He	0.18	H ₂ O	1.12
Ne	0.30	NO	1.16
D ₂	0.35	Ar	1.29
H ₂	0.46	CO ₂	1.42
N ₂	1.00	Kr	1.94
Air	1.00	SF ₆	2.50
O ₂	1.01	Xe	2.87
CO	1.05	Hg	3.64

Example

ANALOG OUT 1 selected is IG LOG N-10. The gas in use is argon. Voltage output is 4 volts. Pressure unit is Torr.

$$P (\text{nitrogen}) = 10^{(\text{volts} - 10)}$$

$$P = 10^{(4 - 10)}$$

$$P = 1.00 \times 10^{-6} \text{ Torr (based on nitrogen)}$$

Applying the Gas Correction Factor of 1.29 for argon listed in the table above,

$$P (\text{argon}) = \frac{1.0 \times 10^{-6}}{1.29} = 7.75 \times 10^{-7} \text{ Torr true pressure of argon gas}$$

The correction factor must be applied to the analog output over the entire pressure range measured by the ion gauge.

8.3.2 IG - CG1 0.5 - 7V Analog Output Correction Factors for Selected Gases

When using the IG - CG1 or IG - CG2 analog output mode (Log-Linear 0.5 - 7 V, 0.5 V/decade) for gases other than N₂ / Air, the analog output is interpreted differently over two different pressure ranges as discussed below:

- A) Pressure range for IG from 4.00×10^{-10} Torr to overpressure shut down value listed in section 5.4, use the correction factors listed in section 8.3.2.1 below to determine pressure from the voltage for selected gases (ion gauge range).
- B) Pressure range of overpressure shut down value listed in section 5.4 to 1000 Torr Use the correction factors listed in section 8.3.2.2 below to determine pressure from the voltage for selected gases (convection gauge range).

8.3.2.1 IG-CG1 0.5 - 7V Analog Output Correction Factors - Ion Gauge Range

A) When using the IG - CG1 or IG - CG2 analog output mode (Log-Linear 0.5 - 7 V, 0.5 V / decade) for gases other than N₂ / Air, use the following steps to convert the analog output to pressure for IG when operating in the pressure range of 4.00×10^{-10} Torr to overpressure shut down values listed in section 5.4.

B) Refer to section 7.1 and related equation to convert the voltage in your receiving instrument to pressure. This pressure value is based on nitrogen.

C) Apply the gas correction factor for the particular gas you are using to the pressure value obtained in step A (Use correction factors and example listed below).

Ion Gauge Gas Correction Factors for selected gases

Gas	Gas CorrectionFactor	Gas	Gas Correction Factor
He	0.18	H ₂ O	1.12
Ne	0.30	NO	1.16
D ₂	0.35	Ar	1.29
H ₂	0.46	CO ₂	1.42
N ₂	1.00	Kr	1.94
Air	1.00	SF ₆	2.50
O ₂	1.01	Xe	2.87
CO	1.05	Hg	3.64

Example

The gas in use is argon. Output voltage is 3 volts. Pressure unit is Torr.

$$P(\text{nitrogen}) = 10^{\frac{\text{volts}-5.5}{0.5}} = 10^{(3.0-5.5)/(0.5)}, P = 1.00 \times 10^{-5} \text{ Torr (based on nitrogen)}$$

$$P(\text{argon}) = \frac{1 \times 10^{-5}}{1.29} = 7.75 \times 10^{-6} \text{ Torr true pressure of argon gas}$$

The same correction factor must be applied over the entire pressure range as measured by the ion gauge.

8.3.2.2 IG-CG1 0.5 - 7V Analog Output Correction Factors - Convection Gauge Range

When using the IG - CG1 or IG - CG2 analog output mode (Log-Linear 0.5 - 7 V, 0.5 V/decade) for gases other than N₂ / Air, use the following look-up table and information to convert the analog output to pressure when operating in the pressure range of overpressure shutdown value listed in section 5.4 to 1000 Torr. The look-up table has been derived from equation listed in section 7.1.

Analog output IG - CG1 or IG - CG2 when in the pressure range of overpressure shutdown value to 1000 Torr

True Pressure (Torr)	N2	Ar	He	O2	CO2	KR	Freon12	Freon22	D2	Ne	CH ₄
1.00E-3	4.000	3.923	3.952	4.000	4.021	3.801	4.088	4.088	4.057	3.923	4.115
2.00E-3	4.151	4.073	4.102	4.151	4.181	4.000	4.246	4.246	4.190	4.088	4.259
5.00E-3	4.349	4.259	4.301	4.349	4.322	4.181	4.440	4.423	4.389	4.272	4.443
1.00E-2	4.500	4.410	4.454	4.493	4.521	4.341	4.584	4.565	4.541	4.426	4.592
2.00E-2	4.651	4.559	4.603	4.648	4.673	4.489	4.738	4.717	4.693	4.575	4.741
5.00E-2	4.849	4.755	4.804	4.846	4.870	4.686	4.930	4.919	4.889	4.771	4.944
1.00E-1	5.000	4.904	4.957	4.994	5.015	4.835	5.078	5.067	5.041	4.923	5.101
2.00E-1	5.151	5.050	5.109	5.144	5.161	4.980	5.220	5.209	5.199	5.075	5.249
5.00E-1	5.349	5.247	5.319	5.343	5.345	5.168	5.393	5.387	5.418	5.278	5.446
1.00E+0	5.500	5.389	5.487	5.493	5.489	5.301	5.511	5.509	5.595	5.436	5.602
2.00E+0	5.651	5.528	5.673	5.644	5.616	5.423	5.605	5.610	5.808	5.601	5.761
5.00E+0	5.849	5.695	6.065	5.849	5.762	5.554	5.695	5.709	6.695	5.860	5.938
1.00E+1	6.000	5.801		6.006	5.848	5.625	5.736	5.765		6.166	6.223
2.00E+1	6.151	5.882		6.174	5.909	5.680	5.761	5.785		6.883	6.775
5.00E+1	6.349	5.947		6.445	5.957	5.705	5.789	5.809			6.963
1.00E+2	6.500	5.973		6.660	5.983	5.719	5.835	5.846			
2.00E+2	6.651	5.995		6.735	6.045	5.761	5.889	5.904			
3.00E+2	6.739	6.027		6.790	6.114	5.778	5.919	5.938			
4.00E+2	6.801	6.065		6.843	6.175	5.798	5.941	5.963			
5.00E+2	6.849	6.103		6.891	6.229	5.812	5.959	5.982			
6.00E+2	6.889	6.137		6.932	6.281	5.824	5.974	5.999			
7.00E+2	6.923	6.169		6.967	6.332	5.834	5.987	6.015			
7.60E+2	6.940	6.187		6.987	6.366	5.838	5.995	6.023			
8.00E+2	6.952	6.200		6.999	6.387	5.842	5.999	6.028			
9.00E+2	6.977	6.227			6.450	5.849	6.011	6.040			
1.00E+3	7.000	6.256			6.523	5.853	6.023	6.052			

Values listed under each gas type are in volts (V).

Example

The gas in use is O₂. Voltage output is 5.144 volts.
True pressure of O₂ is 2.00E-01 Torr

8.3.3 Convection gauge analog output for selected gases

If you intend to use any of the analog outputs to represent measurements from CG1 or CG2 for gases other than N₂ / Air, you must also apply corrections to the analog output. Use the following tables to determine pressure from voltage for gases other than nitrogen or air.

8.3.3.1 CG1 1 - 8 V or CG2 1 - 8 V Analog Output Correction Factors - Convection Gauge

When using the Log-Linear convection gauge analog output mode (Log-Linear 1 - 8 V, 1 V/decade) for gases other than N₂ / Air, use the following look-up table and information to convert the analog output to pressure. The look-up table has been derived from the equation provided in section 7.7

Analog Output for Log-Linear CG1 1-8V or CG2 1-8V

True Pressure (Torr)	N ₂	Ar	He	O ₂	CO ₂	KR	Freon12	Freon22	D ₂	Ne	CH ₄
1.00E-4	1.000	1.000	1.000	1.000	1.000	1.000	1.000	1.000	1.000	1.000	1.000
2.00E-4	1.301	1.301	1.301	1.301	1.301	1.301	1.301	1.301	1.301	1.301	1.301
5.00E-4	1.699	1.699	1.699	1.699	1.699	1.477	1.699	1.699	1.699	1.699	1.699
1.00E-3	2.000	1.845	1.903	2.000	2.041	1.602	2.176	2.176	2.114	1.845	2.230
2.00E-3	2.301	2.146	2.204	2.301	2.362	2.000	2.491	2.491	2.380	2.176	2.519
5.00E-3	2.699	2.519	2.602	2.699	2.643	2.362	2.881	2.845	2.778	2.544	2.886
1.00E-2	3.000	2.820	2.908	2.987	3.041	2.681	3.167	3.130	3.083	2.851	3.185
2.00E-2	3.301	3.117	3.207	3.297	3.346	2.978	3.476	3.435	3.386	3.149	3.483
5.00E-2	3.699	3.511	3.607	3.692	3.740	3.371	3.860	3.839	3.778	3.542	3.888
1.00E-1	4.000	3.808	3.914	3.988	4.029	3.670	4.155	4.134	4.083	3.845	4.201
2.00E-1	4.301	4.100	4.217	4.288	4.322	3.960	4.439	4.418	4.398	4.149	4.498
5.00E-1	4.699	4.494	4.638	4.687	4.689	4.336	4.786	4.774	4.837	4.555	4.893
1.00E+0	5.000	4.778	4.973	4.987	4.978	4.602	5.021	5.017	5.190	4.872	5.204
2.00E+0	5.301	5.057	5.346	5.288	5.233	4.845	5.210	5.220	5.616	5.201	5.522
5.00E+0	5.699	5.389	6.130	5.697	5.524	5.107	5.389	5.418	7.391	5.719	5.877
1.00E+1	6.000	5.602		6.013	5.696	5.250	5.471	5.530		6.332	6.446
2.00E+1	6.301	5.763		6.348	5.819	5.360	5.521	5.571		7.766	7.550
5.00E+1	6.699	5.895		6.890	5.915	5.410	5.579	5.617			7.925
1.00E+2	7.000	5.946		7.320	5.966	5.438	5.670	5.691			
2.00E+2	7.301	5.991		7.470	6.090	5.521	5.777	5.808			
3.00E+2	7.477	6.053		7.580	6.228	5.555	5.838	5.876			
4.00E+2	7.602	6.130		7.686	6.350	5.595	5.883	5.925			
5.00E+2	7.699	6.207		7.781	6.458	5.624	5.918	5.964			
6.00E+2	7.778	6.274		7.863	6.561	5.647	5.947	5.998			
7.00E+2	7.845	6.338		7.934	6.664	5.667	5.974	6.029			
7.60E+2	7.881	6.375		7.974	6.732	5.677	5.989	6.045			
8.00E+2	7.903	6.400		7.999	6.774	5.685	5.998	6.057			
9.00E+2	7.954	6.455			6.900	5.698	6.021	6.079			
1.00E+3	8.000	6.512			7.045	5.706	6.045	6.104			

Values listed under each gas type are in volts (V).

Example

The gas in use is O₂. Voltage output is 4.288 volts.
True pressure of O₂ is 2.00E-01 Torr

8.3.3.2 CG1 0 - 7 V or CG2 0 - 7 V Analog Output Correction Factors - Convection Gauge

When using the Log-Linear convection gauge analog output mode (Log-Linear 0 - 7 V, 1 V/decade) for gases other than N₂ / Air, use the following look-up table and information to convert the analog output to pressure. The look-up table has been derived from the equation provided in section 7.8

True Pressure (Torr)	N ₂	Ar	He	O ₂	CO ₂	KR	Freon12	Freon22	D ₂	Ne	CH ₄
1.00E-4	0.000	0.000	0.000	0.000	0.000	0.000	0.000	0.000	0.000	0.000	0.000
2.00E-4	0.301	0.301	0.301	0.301	0.301	0.301	0.301	0.301	0.301	0.301	0.301
5.00E-4	0.699	0.699	0.699	0.699	0.699	0.477	0.699	0.699	0.699	0.699	0.699
1.00E-3	1.000	0.845	0.903	1.000	1.041	0.602	1.176	1.176	1.114	0.845	1.230
2.00E-3	1.301	1.146	1.204	1.301	1.362	1.000	1.491	1.491	1.380	1.176	1.519
5.00E-3	1.699	1.519	1.602	1.699	1.643	1.362	1.881	1.845	1.778	1.544	1.886
1.00E-2	2.000	1.820	1.908	1.987	2.041	1.681	2.167	2.130	2.083	1.851	2.185
2.00E-2	2.301	2.117	2.207	2.297	2.346	1.978	2.476	2.435	2.386	2.149	2.483
5.00E-2	2.699	2.511	2.607	2.692	2.740	2.371	2.860	2.839	2.778	2.542	2.888
1.00E-1	3.000	2.808	2.914	2.988	3.029	2.670	3.155	3.134	3.083	2.845	3.201
2.00E-1	3.301	3.100	3.217	3.288	3.322	2.960	3.439	3.418	3.398	3.149	3.498
5.00E-1	3.699	3.494	3.638	3.687	3.689	3.336	3.786	3.774	3.837	3.555	3.893
1.00E+0	4.000	3.778	3.973	3.987	3.978	3.602	4.021	4.017	4.190	3.872	4.204
2.00E+0	4.301	4.057	4.346	4.288	4.233	3.845	4.210	4.220	4.616	4.201	4.522
5.00E+0	4.699	4.389	6.130	4.697	4.524	4.107	4.389	4.418	6.391	4.719	4.877
1.00E+1	5.000	4.602		5.013	4.696	4.250	4.471	4.530		5.332	5.446
2.00E+1	5.301	4.763		5.348	4.819	4.360	4.521	4.571		6.766	6.550
5.00E+1	5.699	4.895		5.890	4.915	4.410	4.579	4.617			6.925
1.00E+2	6.000	4.946		6.320	4.966	4.438	4.670	4.691			
2.00E+2	6.301	4.991		6.470	5.090	4.521	4.777	4.808			
3.00E+2	6.477	5.053		6.580	5.228	4.555	4.838	4.876			
4.00E+2	6.602	5.130		6.686	5.350	4.595	4.883	4.925			
5.00E+2	6.699	5.207		6.781	5.458	4.624	4.918	4.964			
6.00E+2	6.778	5.274		6.863	5.561	4.647	4.947	4.998			
7.00E+2	6.845	5.338		6.934	5.664	4.667	4.974	5.029			
7.60E+2	6.881	5.375		6.974	5.732	4.677	4.989	5.045			
8.00E+2	6.903	5.400		6.999	5.774	4.685	4.998	5.057			
9.00E+2	6.954	5.455			5.900	4.698	5.021	5.079			
1.00E+3	7.000	5.512			6.045	4.706	5.045	5.104			

Values listed under each gas type are in volts (V (dc)).

Example

The gas in use is O₂. Voltage output is 3.288 volts.
True pressure of O₂ is 2.00E-01 Torr

8.3.3.3 CG1 NON-LIN or CG2 NON-LIN Analog Output Correction Factors - Convection Gauge

When using the Non-Linear convection gauge analog output mode for gases other than N₂ / Air, use the following look-up table and information to convert the analog output to pressure. The look-up table has been derived from the equation provided in section 7.9

True Pressure (Torr)	N ₂	Ar	He	O ₂	CO ₂	KR	Freon12	Freon22	D ₂	Ne	CH ₄
0	0.3751	0.375	0.375	0.375	0.375	0.375	0.375	0.375	0.375	0.375	0.375
1.00E-4	0.3759	0.3757	0.3755	0.376	0.376	0.3755	0.376	0.376	0.376	0.3757	0.3766
2.00E-4	0.3768	0.376	0.3765	0.377	0.377	0.3768	0.378	0.378	0.377	0.3763	0.378
5.00E-4	0.3795	0.378	0.379	0.38	0.381	0.3772	0.382	0.381	0.381	0.3782	0.3825
1.00E-3	0.384	0.381	0.382	0.384	0.385	0.379	0.388	0.388	0.386	0.381	0.3896
2.00E-3	0.3927	0.387	0.389	0.392	0.395	0.384	0.401	0.4	0.396	0.388	0.403
5.00E-3	0.4174	0.403	0.409	0.417	0.412	0.395	0.437	0.432	0.425	0.405	0.438
1.00E-2	0.4555	0.429	0.441	0.453	0.462	0.415	0.488	0.48	0.47	0.433	0.492
2.00E-2	0.5226	0.477	0.497	0.521	0.536	0.451	0.581	0.566	0.549	0.484	0.584
5.00E-2	0.6819	0.595	0.637	0.679	0.705	0.544	0.778	0.764	0.727	0.608	0.796
1.00E-1	0.878	0.745	0.814	0.868	0.9	0.668	1.009	0.99	0.944	0.768	1.053
2.00E-1	1.1552	0.962	1.068	1.141	1.179	0.847	1.315	1.291	1.265	1.002	1.392
5.00E-1	1.6833	1.386	1.589	1.664	1.668	1.194	1.826	1.805	1.914	1.469	2.014
1.00E+0	2.2168	1.818	2.164	2.195	2.172	1.536	2.257	2.247	2.603	1.976	2.632
2.00E+0	2.8418	2.333	2.939	2.814	2.695	1.921	2.647	2.666	3.508	2.631	3.313
5.00E+0	3.6753	3.028	4.387	3.672	3.316	2.429	3.029	3.09	5.059	3.715	
1.00E+1	4.2056	3.48	5.774	4.225	3.67	2.734	3.204	3.33	6.361	4.605	4.699
2.00E+1	4.5766	3.801	7.314	4.62	3.903	2.966	3.308	3.414		5.406	5.172
5.00E+1	4.8464	4.037		4.916	4.071	3.075	3.43	3.509		6.159	5.583
1.00E+2	4.9449	4.122		5.026	4.154	3.134	3.618	3.66		6.483	5.72
2.00E+2	5.019	4.192		5.106	4.336	3.269	3.827	3.883		6.661	5.86
3.00E+2	5.1111	4.283		5.2	4.502	3.384	3.938	4.005		6.726	
4.00E+2	5.2236	4.386		5.315	4.621	3.466	4.016	4.088		6.767	6.103
5.00E+2	5.3294	4.477		5.422	4.708	3.526	4.076	4.151		6.803	
6.00E+2	5.4194	4.55		5.515	4.775	3.573	4.124	4.203		6.843	6.342
7.00E+2	5.4949	4.611		5.592	4.83	3.613	4.166	4.247		6.89	
7.60E+2	5.534	4.643		5.633	4.86	3.632	4.19	4.271		6.92	
8.00E+2	5.5581	4.663		5.658	4.877	3.645	4.203	4.286		6.942	6.519
9.00E+2	5.6141	4.706		5.713	4.919	3.674	4.237	4.321		7	
1.00E+3	5.6593	4.745		5.762	4.955	3.69	4.27	4.354		7.056	6.642

Values listed under each gas type are in volts (V (dc)).

9 Communication Protocol (Serial Interface)

9.1 Device Specific Serial Communication Info

The VGC083 provides RS232 and RS485 serial communications capability. The following information and the command protocol summaries listed in the following sub-sections of this chapter can be used to establish serial communications with the device. Six distinct protocols (COMM type) are defined: INFICON RS232 and RS485 protocol, RS232 and RS485 protocols compatible with GP series 307 and 358 controllers, and RS232 and RS485 protocols compatible with GP series 350 controllers. Note that GP 350 compatibility was implemented in January 2018. The user has access from the front panel main menu to change settings for COM Type, Baud Rate, Data Bits, Parity, Stop Bits and device Address (when using RS485).

Baud Rate is selectable at 300, 600, 1200, 2400, 4800, 9600, 19200 or 38400 baud.

Data bits may be set to either 7 or 8.

Parity selection may be set to None, Even or Odd.

Either 1 or 2 Stop Bits may be selected.

The device address when using RS485 can be within the range 00 to FF hexadecimal (Default = 01).

There is a finite period of time between the time a command is sent from a terminal (PC COM Port, for example) and the point in time in which the VGC083 starts to send a response to that command. This delay is dependent upon the command sent and the baud rate.

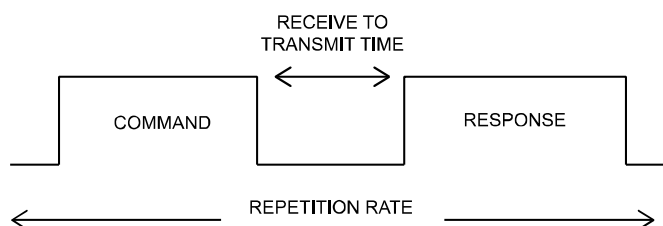

The maximum command repetition rate will depend on the length of the command sent and the response received, as well as the baud rate. The maximum repetition rate for the baud rate you are using can be found in the following table:

Selected Baud Rate	Repetition Rate	Receive to Transmit Time
38400	38 ms	26 μ s
19200	46 ms	52 μ s
9600	61 ms	1.0 ms
4800	93 ms	2.0 ms
2400	156 ms	4.1 ms
1200	280 ms	8.3 ms
600	530 ms	16 ms
300	1030 ms	33 ms

9.2 INFICON RS232 / RS485 Command Protocol Summary

The following notes are intended to be understood by the user when using INFICON's RS232 and RS485 command protocol with the VGC083.

1. Default settings are 19,200 baud rate, 8 data bits, No Parity, 1 stop bit.
2. The baud rate can be set to different values using the front panel soft-keys.
3. All Responses are 13 characters long when COMM TYPE menu selected is RS485 or RS232.
5. 'xx' is the address of the device (00 thru FF). For RS232, 'xx' is replaced with two space characters.

6. <CR> is a carriage return, a non-printable character. Do not enter <CR> from your keyboard. A carriage return, non-printable character may be entered as the Unicode C0 controls specified value: 0D hexadecimal (13 decimal). From your keyboard, a key entry sequence of CNTL-M may be used to obtain the required character for a carriage return when using certain terminal emulator programs.
7. '_' represents a 'space' character. Press the space bar on your keyboard. Do not enter a '_' (underscore) character.
8. All commands sent to the controller start with a '#' character, and all normal responses from the controller start with a '*' character. Error responses start with a "?".
9. A valid address must be used [Factory default = 01] when using the RS485 protocol. The VGC083 will not respond to a command with an invalid address while using RS485.
10. The command syntax examples used in the protocol summary table for ASCII are shown in scientific notation. However, floating point notation is acceptable as long as a leading digit is entered as '0.' or '1.', etc. There must be a digit to the left of the decimal point. For example, when constructing the syntax for the command to set the CGn zero value (e.g., #xxTZn_x.xxE-pp<CR> when using scientific notation), use either #xxTZn_0.00<CR>, or #xxTZn_0<CR>. A simple '0' is valid for the pressure entry.

9.3 INFICON RS232 and RS485 Command Protocol Summary

The RS232 mode is the same as RS485, except ADDRESS is ignored in RS232 mode and must be eliminated from the command string or replaced with space characters. Responses will not return ADDRESS; the ADDRESS is replaced with space characters. Response is 13 characters including carriage return. All pressure measurement responses are in absolute pressure units as selected by the user. Please see qualifying notes at bottom of table.

Table "INFICON RS232 and RS485 Command Protocol Summary"

COMMAND	BRIEF DESCRIPTION	COMMAND SYNTAX	RESPONSE - EXAMPLES
READ ION GAUGE PRESSURE	Read the current displayed pressure of the ion gauge in the same units of measure on display	#xxRDIG<CR> e.g.: #01RDIG<CR> where, xx = the two digit address of the device (node)	*xx_y.yyEzpp<CR> where, y.yy = mantissa, z = sign of the exponent +/- and pp = the exponent e.g.: *01_1.53E-06<CR> When IG is off: *01_1.10E+03
READ CGn PRESSURE	Read the current pressure for CGn in the same units of measure on display	#xxRDCGn<CR> e.g.: #01RDCG1<CR> where, n=1 or 2 (CG1 or CG2)	*xx_y.yyEzpp <CR> e.g.: *01_7.60E+02<CR> When CG is over ranged: *01_1.10E+03
READ AI Pressure	Read the current pressure for AI in the same units of measure on display	#xxRDAI<CR> e.g.: #01RDAI<CR>	*xx_y.yyEzpp <CR> e.g.: *01_7.60E+02<CR> When AI is over ranged or not powered: *01_1.10E+03

(continued)

Table "INFICON RS232 and RS485 Command Protocol Summary" (continued)

COMMAND	BRIEF DESCRIPTION	COMMAND SYNTAX	RESPONSE - EXAMPLES
READ all Process Control (PC, or Relay) states	Read the current state of all process control setpoint relays	#xxRL<CR> e.g.: #01RL<CR>	*xx_003F_RL_<CR> In the example response above, the 'F' represents the first 4 relays; relays 5 and 6 are the second digit (the '3') of the response. This example shows that all relays are ON, i.e., energized. The '3F' would represent the binary string of 0011 1111, where 0011 is the 3 and 1111 is the F in '3F' A response of 0003 means that only RL1 and RL2 are ON, i.e., energized
READ one PC state	Read the current state of one process control setpoint	#xxRLn<CR> where n = 1,2,3,4,5 or 6 e.g., : #01RL1<CR>	*xx_0_RL_OFF<CR> *xx_1_RL_ON_<CR>
READ IG on/off STATUS	Find out if Ion Gauge is turned to ON and gauge is reading pressure	#xxIGS<CR> e.g., : #01IGS<CR>	*xx_0_IG_OFF<CR> *xx_1_IG_ON_<CR>
TURN IG ON	Turn the Ion Gauge ON	#xxIG1<CR> e.g.: #01IG1<CR> #xxIGy<CR> where, Y=1= Turn ON; y=0= Turn OFF	*xx_PROGM_OK<CR> When IG error exists: ?01_INVALID_<CR> When IG controlled by CG: ?01_INVALID_<CR> To clear IG errors send an IG OFF command: y=0=IG OFF (this clears IG errors and allows user to reactivate IG control)
TURN IG OFF	Turn the Ion Gauge OFF	#xxIG0<CR> e.g., : #01IG0<CR> #xxIGy<CR> where, Y=1= Turn ON; y=0= Turn OFF	*xx_PROGM_OK<CR> Even though the IG will already be OFF, when an IG Error occurs, sending the IG OFF command will clear errors When IG device is not connected: ?01_INVALID_<CR>
READ DEGAS on/off STATUS	Find out if Degas is ON or OFF	#xxDGS<CR> e.g.: #01DGS<CR>	*xx_0_DG_OFF<CR> *xx_1_DG_ON_<CR>
TURN ON Degas	Turn ON the Ion Gauge Degas	#xxDG1<CR> e.g.: #01DG1<CR> #xxDGy<CR> where, Y=1= Turn ON; y=0= Turn OFF	*xx_PROGM_OK<CR> When IG off: ?01_INVALID_<CR> When P > 5E-05 Torr: ?01_INVALID_<CR>
TURN OFF Degas	Turn OFF the Ion Gauge Degas	#xxDG0<CR> e.g.: #01DG0<CR> #xxDGy<CR> where, Y=1= Turn ON; y=0= Turn OFF	*xx_PROGM_OK<CR>

(continued)

Table "INFICON RS232 and RS485 Command Protocol Summary" (continued)

COMMAND	BRIEF DESCRIPTION	COMMAND SYNTAX	RESPONSE - EXAMPLES
SET EMISSION Current	Choose 10 mA, 4mA or 100uA emission current	#xxSEy<CR> e.g.: #01SE1<CR> where, y=1=4mA; y=0=100µA y=2=10mA	xx_PROGM_OK<CR> When in Auto I _e mode: ?01_INVALID_<CR>
SET FILAMENT	Choose Filament 1 or 2	#xxSFy<CR> e.g.: #01SF1<CR> where, y=1 for F1; y=2 for F2	*xx_PROGM_OK<CR>
Read EMISSION Current	Read emission current setting	#xxSES<CR> e.g.: #01SES<CR>	*xx_0.1MA_EM<CR> *xx_4.0MA_EM<CR> *xx_10_MA_EM<CR>
READ IG STATUS	Finds out the cause of the specified device inactive reading	#xxRSIG<CR> e.g.: #01RSIG<CR> When IG or device is not connected, response is: ?01_INVALID_<CR>	*xx_00_ST_OK (IG status is OK) *xx_01_OVPRS (overpressure-system pressure is too high) *xx_02_EMISS (I _e control fail) *xx_04_FLVLO (low filament voltage condition) *xx_08_FLOPN (selected filament is open circuit) *xx_10_DEGAS (IG is in DEGAS mode of operation) *xx_20_ICLOW (IG collector current is below normal range) *xx_40_FLIHI (filament drive current is too high) *xx_80_OVTMP
READ SW VERSION	Read the part number and revision number (version) of the firmware	#xxVER<CR> e.g.: #01VER<CR>	*xx_mmmmm-vv e.g., : *01_01306-11 <CR>
SET CG _n ZERO	Set the zero or vacuum calibration point for CG _n	#xxTZCG _n <CR> e.g.: #01TZCG1_0<CR> e.g.: #01TZCG2_1.23E-02 <CR> where, n=1 or 2 (for, CG1 or CG2) y.yy = mantissa, z = sign of the exponent +/- and pp = the exponent	*xx_PROGM_OK<CR> When P > 100 mTorr: ?01_INVALID_<CR> When CG is not connected: ?01_INVALID_<CR> When requested gauge number <1 or >2: ?01_SYNTAX_ER <CR>
SET CG _n SPAN	Set the span or atmosphere calibration point for CG _n	#xxTSCG _n _y.yyEzpp<CR> e.g.: #01TSCG1_7.60E+02<CR> where, n=1 or 2 (for, CG1 or CG2) y.yy = mantissa, z = sign of the exponent +/- and pp = the exponent	*xx_PROGM_OK<CR> When P < 400 Torr: ?01_INVALID_<CR> When requested P < 400Torr: ?01_INVALID_<CR> When requested P > 1000mT: ?01_INVALID_<CR> When CG is not connected: ?01_INVALID_<CR> When requested gauge number <1 or >2: ?01_SYNTAX_ER <CR>

(continued)

Table "INFICON RS232 and RS485 Command Protocol Summary" (concluded)

COMMAND	BRIEF DESCRIPTION	COMMAND SYNTAX	RESPONSE - EXAMPLES
READ IG EMISSION CURRENT	Read the actual IG emission current being measured by the gauge	#xxRDIGE<CR> (e.g.: #01RDIGE<CR>)	*xx_y.yyEzpp<CR> (eg: *01_1.00E-04<CR>) When IG is off: *01_0.00E+00
READ IG FILAMENT VOLTAGE	Read the current IG filament voltage	#xxRDIGV<CR> (e.g.: #01RDIGV<CR>)	*xx_y.yyEzpp<CR> (eg: *01_2.30E+00<CR>) When IG is off: *01_0.00E+00
READ IG FILAMENT CURRENT	Read the current IG filament current	#xxRDIGA<CR> (e.g.: #01RDIGA<CR>)	*xx_y.yyEzpp<CR> (eg: *01_3.10E+00<CR>) When IG is off: *01_0.00E+00
READ IG ION CURRENT	Read the current IG ion current	#xxRDIGC<CR> (e.g.: #01RDIGC<CR>)	*xx_y.yyEzpp<CR> (eg: *01_4.77E-09<CR>) When IG is off electrometer offset voltage is indicated: *01_9.64E-03
GET FILAMENT SELECTION	Read current filament selection	#xxRF<CR> (e.g.: #01SF<CR>)	*xx_FIL SEL1<CR> *xx_FIL SEL2<CR>

NOTES:

1. <CR> is a carriage return (0x0D). This is the terminator character.
2. The '_' used in certain defined commands represent a space character. Space characters may be omitted from commands.
3. Hardware handshake controls do not exist on VGC083 (e.g., RTS, CTS, DTR).

9.4 RS232 GP 307 and 358 Protocol

RS232 protocol compatible with the GP Series 307 and 358 VGC is as defined in the following table. Please see qualifying notes at bottom of table.

Table "RS232 GP 307 and 358 Protocol"

COMMAND	BRIEF DESCRIPTION	COMMAND SYNTAX	RESPONSE - EXAMPLES
READ IG _n or, READ IG	Read the current IG pressure in units of Torr only, 1 = fil1, 2 = fil2 If you have selected filament 1 to operate with the IG ON (see 'IG ON' below), then enter IG1 in the READ IG _n command; use IG2 if filament 2 is turned ON	DS_IG _n <CR> <LF> e.g.: DS_IG1<CR><LF> or DS_IG<CR> <LF> e.g.: DS_IG1<CR><LF>	y.yyEzpp<CR><LF> e.g.: 1.53E-06<CR><LF> where, y.yy = mantissa, z = sign of the exponent +/- and pp = the exponent When IG is off: 9.90E+09
READ CG _n	Read the current CG pressure in units of Torr only	DS_CG _n <CR> <LF> e.g.: DS_CG1<CR><LF> where, n = 1 for device CG1 and n = 2 for CG2	y.yyEzpp<CR><LF> e.g.: 1.53E+02<CR><LF> When CG is not connected: 9.90E+09 When CG is over ranged: 9.90E+09
READ PCs in long form	Read the current Process Control setpoint relay status	PCS<CR> <LF> e.g.: PCS<CR><LF>	x,x,x,x,x,x,x,x<CR><LF> e.g.: 1,1,0,0,0,0<CR><LF> Relays 1 and 2 are energized; order is Relay No.1,2,3,4,5,6 from left to right.
READ PCs in binary form	Read the current Process Control setpoint relay status {continued on next page} {continued from previous page}	PCS_B<CR> <LF> e.g.: PCS_B<CR><LF>	x<CR><LF> e.g.: C<CR><LF> The Latin alphabet character "C" corresponds to binary 01000011 or, 43hex, which represents relay 1 and relay 2 are energized (ON). Note that the positions of the relay order in the returned code character are reversed from the long form as described for the READ PCs in long form command above. In binary form, the order is Relay No.6, 5, 4, 3, 2, and 1 as read from left to right.
READ individual PC	Read the current individual Process Control setpoint relay status	PCS_n<CR> <LF> e.g.: PCS_1<CR><LF>	s<CR><LF> where, s=state of relay: 1 = ON; 0 = OFF e.g.: 1<CR><LF> (PC Relay 1 is energized, or 0 when not)
IG ON	Turn specified IG filament ON Note that the functions of IG ON/OFF and Filament Selection are combined in the single IG ON/OFF command. When turning the IG to ON, the specific filament chosen is selected when sending the IG ON/OFF commands.	IG _n _ON<CR> <LF> e.g.: IG1_ON<CR><LF> where, n = 1 = fil1, 2 = fil2	OK<CR><LF> e.g.: OK<CR><LF> When IG is already ON: INVALID

(continued)

Table "RS232 GP 307 and 358 Protocol" (concluded)

COMMAND	BRIEF DESCRIPTION	COMMAND SYNTAX	RESPONSE - EXAMPLES
IG OFF	Turn specified IG filament OFF	IGn_OFF<CR> <LF> e.g.: IG1 OFF<CR><LF> where, n = 1 = fil1, 2 = fil2	OK<CR><LF> e.g.: OK<CR><LF> When IG is already OFF: INVALID
IG DEGAS ON	Turn IG Degas ON	DG_ON<CR> <LF> e.g.: DG ON<CR><LF>	OK<CR><LF> e.g.: OK<CR><LF> When Degas is already ON: INVALID When IG is OFF: INVALID
IG DEGAS OFF	Turn IG Degas OFF	DG_OFF<CR> <LF> e.g.: DG OFF<CR><LF>	OK<CR><LF> e.g.: OK<CR><LF> When Degas is already OFF: INVALID
IG Degas Status	Detect Degas on/off status	DGS<CR> <LF> e.g.: DGS<CR><LF>	1<CR><LF> e.g.: 1<CR><LF> When IG is ON, or 0<CR><LF> when off

NOTES:

1. <CR> is a carriage return (0x0D).
2. <LF> is a line feed (0x0A); this is the terminator character.
3. The '_' used in certain defined commands represent a space character. Space characters may be omitted from commands.
4. GP 307 and 358 protocol response strings are variable length.
5. Hardware handshake controls do not exist on VGC083 (e.g., RTS, CTS, DTR).

9.5 RS485 GP 307 and 358 Protocol

RS485 protocol compatible with the GP Series 307 and 358 VGC is as defined in the following table. Please see the qualifying notes listed at bottom of table.

Table "RS485 GP 307 and 358 Protocol"

COMMAND	BRIEF DESCRIPTION	COMMAND SYNTAX	RESPONSE - EXAMPLES
READ IGn or, READ IG	Read the current IG pressure in units of Torr only	#xxDS_IGn<CR> e.g.: #01DS IG1<CR> where, n = 1 = fil1, 2 = fil2 or DS_IG<CR> <LF> e.g.: DS_IG1<CR><LF>	y.yyEzpp<CR> e.g.: 1.53E-06<CR> where, y.yy = mantissa, z = sign of the exponent +/- and pp = the exponent When IG is off: 9.90E+09

(continued)

Table "RS485 GP 307 and 358 Protocol" (concluded)

COMMAND	BRIEF DESCRIPTION	COMMAND SYNTAX	RESPONSE - EXAMPLES
READ CGn	Read the current CG pressure in units of Torr only	#xxDS_CGn<CR> e.g.: #01DS CG1<CR> where, n = 1 or 2 (CG1 or CG2)	y.yyEzpp<CR> where, y.yy = mantissa, z = sign of the exponent +/- and pp = the exponent e.g.: 1.53E+02<CR> When CG is not connected: 9.90E+09 When CG is over ranged: 9.90E+09
READ PCs long form	Read the current PC setpoint status	#xxPCS<CR> e.g.: #01PCS<CR>	x,x,x,x,x,x,x<CR> e.g.: 1,1,0,0,0,0<CR> (Relays 1 and 2 are energized; Relays 3 - 6 are not energized)
READ PCs binary form	Read the current PC setpoint status	#xxPCS_B<CR> e.g.: #01PCS B<CR>	x<CR> e.g.: C<CR> (where 'C' is the Unicode character C, expressed as 01000011 in binary notation or 43 hexadecimal)
READ individual PC	Read the current individual PC setpoint status	#xxPCS_x<CR> e.g.: #01PCS_1<CR><LF>	x<CR> e.g.: 1<CR> (where '1' indicates PC 1 is energized; 0 when not)
IG ON	Turn specified IG filament ON	#xxIGn_ON<CR> e.g.: #01IG1 ON<CR> where, n = 1 = fil1, 2 = fil2	OK<CR> e.g.: OK<CR> When IG already ON: INVALID
IG OFF	Turn specified IG filament OFF	#xxIGn_OFF<CR> e.g.: #01IG1 OFF<CR> n = 1 = fil1, 2 = fil2	OK<CR> e.g.: OK<CR> When IG already OFF: INVALID
IG DEGAS ON	Turn IG Degas ON	#xxDG_ON<CR> <LF> e.g.: #01DG_ON<CR>	OK<CR> e.g.: OK<CR> When Degas already ON: INVALID When IG is OFF: INVALID
IG DEGAS OFF	Turn IG Degas OFF	#xxDG_OFF<CR> e.g.: #01DG_OFF<CR>	OK<CR> e.g.: OK<CR> When Degas already OFF: INVALID
IG Degas Status	Detect Degas on/off status	#xxDGS<CR> e.g.: #01DGS<CR>	1<CR> e.g.: 1<CR> (or 0 when off)

NOTES:

1. <CR> is a carriage return (0x0D). This is the terminator character.
2. The '_' used in certain defined commands represent a space character. Space characters may be omitted from commands.
3. GP 307 and 358 protocol response strings are variable length.

9.6 RS232 and RS485 GP 350 Protocol

RS232 and RS485 protocol compatible with the GP 350 controller is as defined in the following table. The RS232 mode is the same as RS485, except ADDRESS is ignored in RS232 mode and must be eliminated from the command string or replaced with space characters. Responses will not return ADDRESS. All pressure measurement responses are in absolute pressure units as selected by the user. Response is 11 characters including carriage return. Please see the qualifying notes listed at bottom of table.

Table "RS232 and RS485 GP 350 Protocol"

COMMAND	BRIEF DESCRIPTION	COMMAND SYNTAX	RESPONSE - EXAMPLES
READ IGx	Read the current IG pressure, 1=fil1, 2=fil2, no char=active fil	#xxRDx<CR> (e.g.: #01RD1<CR>)	*_y.yyEzyy<CR> (e.g.: * 1.53E-06<CR>) When IG is off: * 9.90E+09
READ CGx	Read the current CG pressure, A=CG1, B=CG2, l=analog input	#xxRDx<CR> (e.g.: #01RDA<CR>)	*_y.yyEzyy<CR> (e.g.: * 1.53E+02<CR>) When CG is over-ranged: * 9.90E+09
READ PCs long form	Read the current PC setpoint status	#xxPCS<CR> (e.g.: #01PCS<CR>)	*_xxxx__<CR> (e.g.: * 1100<CR>) (1 and 2 are energized) Note: only relays 1-4 are represented.
READ PCs binary form	Read the current PC setpoint status	#xxPCB<CR> (e.g.: #01PCB<CR>)	*_x____<CR> (e.g.: C<CR>) (01000011 or 43hex) (1 and 2 are energized)
READ individual PC	Read the current individual PC setpoint status 1 - 6	#xxPCx<CR> (e.g.: #01PC1<CR>)	*_x____<CR> (e.g.: * 1<CR>) (PC 1 is energized, 0 when not)
PROGRAM PC Setpoint	PC 1 – 6, Setpoint range 1e-12 to 1e+3 Torr	#xxPC1_7.6E-06<CR> (e.g.: #01PC1 7.6E-06<CR>)	*_PROGM_OK<CR> (e.g.: * PROGM_OK <CR>) When requested value out of range: *_INVALID Hysteresis is 10% of pressure
IG ON	Turn specified IG filament ON 1=on	#xxFx_1<CR> (e.g.: #01F1 1<CR>) (1=fil1, 2=fil2)	*_1IG1_ON_<CR> (e.g.: * 1IG1 ON <CR>)
IG OFF	Turn specified IG filament OFF 0=off	#xxFx 0<CR> (e.g.: #01F1 0<CR>) (1=fil1, 2=fil2)	*_0IG1_OFF<CR> (e.g.: * 0IG1 OFF <CR>)
IG DEGAS ON	Turn IG Degas ON	#xxDG_1<CR> (e.g.: #01DG 1<CR>)	*_1DG_ON_<CR> (e.g.: * 1DG ON <CR>) When Degas already ON: ?_INVALID When IG is OFF: ? INVALID
IG DEGAS OFF	Turn IG Degas OFF	#xxDG_0<CR> (e.g.: #01DG 0<CR>)	*_0DG_OFF_<CR> (e.g.: * DG_OFF <CR>) When Degas already OFF: ?_INVALID
IG Degas Status	Detect Degas on/off status	#xxDGS<CR> (e.g.: #01DGS<CR>)	*_1DG_ON_<CR> (e.g.: * 1DG ON <CR>) (or * 0DG OFF when off)
Software Version	Read Software Version	#xxVER<CR> (e.g.: #01VER<CR>)	*01961-113<CR> (e.g.: 01961-113<CR>) Example part number-revision

NOTES:

1. <CR> is a carriage return (0x0D). This is the terminator character.
2. The '_' used in certain defined commands represent a space character. Space characters may be omitted from commands.
3. Invalid commands will create a response of *_SYNTAX_ER.
4. GP 350 protocol response strings are the same length.

10 Service

10.1 Calibration

Every INFICON module is calibrated prior to shipment using nitrogen. Care should be exercised when using gases other than nitrogen (N₂) / air (see previous sections regarding the use of gases other than N₂/air).

10.2 Troubleshooting - IG Operation

Indication	Possible Cause	Possible Solution
Display on VGC083 controller indicates OFF	No power	Check cable connections and verify that power is being supplied
	The connector may not be wired correctly	Check cable connections and verify that power is being supplied
Readings appear very different from expected pressure	Sensor not in the proper location on vacuum system	Ensure the sensor is located in appropriate location on vacuum chamber
	The process gas is different from the gas (Nitrogen) used to calibrate the IG	Apply gas correction factor if applicable
	Sensor has been dropped causing mechanical damage	Replace the ion gauge sensor tube
	The gauge sensor tube is contaminated	Degas the sensor or replace the sensor
	Leak in the vacuum system	Re-check for leak in the system. Re-check that all metal seals are used when operating below 1.00×10^{-7} Torr
Ion gauge cannot be turned on	Pressure exceeds 1.00×10^{-3} Torr at 0.10 mA (100 μ A) emission current	Decrease pressure below required value
	Pressure exceeds 5.00×10^{-4} Torr at 4 mA emission current	Decrease pressure below required value
	Pressure exceeds 1.00×10^{-4} Torr at 10 mA emission current	Decrease pressure below required value
	Emission Control not functioning	Switch to the other filament, replace ion gauge sensor tube due to possible filament failure or contamination
Research Screen shows filament voltage is present but filament current stays at 0.00	Filament is open	Switch to the other filament, replace sensor or electronics
Research Screen shows filament voltage and filament current are present but gauge is shutting off	Filament is contaminated or burned out	Switch to the other filament or replace sensor
Unable to initiate degas	System pressure above 5.00×10^{-5} Torr	Decrease pressure below the required value
Voltage to filament too high	Filament contaminated or near end of its life	Switch to the other filament or replace sensor
Setpoint does not actuate	Incorrect setup	Check setpoint setup

10.3 Troubleshooting - IG Error Messages

Indication	Possible Cause	Possible Solution
OVERPRESSURE	The calculated pressure is greater than maximum setting for emission current System pressure too high	Change to 100 μ A emission current which will operate at higher pressures Reduce pressure
EMIS FAIL	The desired emission current (IE) could not be established Gauge contamination, possible coating on filament or grid surfaces End of filament life System pressure too high	Switch to 4 mA or 10 mA emission current and attempt repeated filament starts to clean filament Switch to second filament, degas Replace the Ion gauge sensor tube Reduce pressure
LV Failure	The Filament voltage could not be established; Electronics Failure	Contact INFICON
F1 or F2 OPEN	Filament 1 or 2 is open	Switch to the other filament or replace the Ion gauge sensor tube
F1 or F2 OPEN	Faulty electronics	Replace electronics
CONNECT IG	IG not connected Faulty cable	Plug in IG Replace cable
COMM IO FAIL	Internal PCB not communicating	Contact INFICON
OVER TEMP	Ion gauge cable is longer than 50 ft.	Reduce cable length to less than 50 ft. or provide airflow around the VGC083

10.4 Clearing Error Messages - IG

Once the cause of the IG error has been determined and resolved, the IG error must be cleared before the IG filament can be turned on again. To clear errors, simply press the IG ON/OFF key.

10.5 Research Screen

The OLED setup screen of the VGC083 can be configured to display important, critical operating parameters of the ionization gauge. These parameters can be displayed in the Research display mode as described below.

10.5.1 Research Screen (Diagnostic Display - IG)

In addition to the normal pressure measurement screen VGC083 provides a diagnostic display screen that allows you to monitor the measurements of the critical electrical parameters used for measurement of very low pressures, i.e., high vacuum, made by the ionization gauge.

Over time, the hot cathode (filament) of the ionization gauge may degrade. The IG coated iridium filaments are made using yttrium oxide to lower the work function of the heated wire material and enable substantial emission of electrons from the hot cathode. These electrons are accelerated in an electric field toward the grid structure of the ionization gauge device. The electron emission is commonly referred to as the 'Emission Current'. As the emission current electrons orbit within the electric field formed by the bias voltages applied to the grid, collector and filament electrodes, the molecules that the gas is comprised of will be ionized by these energetic electrons.

The positive ions that are created within the grid structure are captured in another electric potential field created by the grid structure (at +180 V (dc) with respect to ground potential) and the collector wire (at zero volts, i.e., ground potential). In simple terms, the ions collected by the collector electrode (a small diameter wire within the grid electrode structure) are measured with an electrometer circuit connected to the collector. The amount of ion current measured is directly proportional to the density of the gas within the ion gauge head. This ion current is commonly referred to as the 'Collector Current'.

From the collector current measured, which is directly proportional to the gas density inside the ion gauge head enclosure, the pressure inside the ion gauge head can be calculated. The Research display screen is a very useful diagnostic tool to troubleshoot issues with the sensor or the electronics.

This mode displays the emission current, ion current, filament voltage and filament current. In the following emission current is 4.00E-3 amperes, Ion current is 4.00E-11 amperes, filament voltage is 4.3 V (dc) and filament current is 4.2 amperes.

Example

Research Display Mode of Critical IG Hot-Cathode Ion Gauge Measurement Parameters

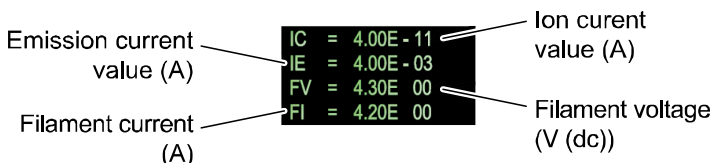

The Pressure, Ion Current (Collector Current) and Emission Current are indications that the ionization gauge head is operating and pressure (vacuum) is being measured. In the above example, most of the critical, measured quantities required for the calculation of measured pressure are displayed. The relationship of these parameters leads to the calculation of pressure given by $P = I_C \times (I_E \times S)^{-1}$ where I_C is the Ion Current, I_E is the Emission Current and S is the Sensitivity of the specific ion gauge sensor.

The pressure indication may be checked by using the displayed values and calculating the pressure as indicated by the top LED display line on the VGC083.

Other important information such as Filament Voltage and Filament Current are also given in the Research display screen. These values vary widely depending upon filament design type, material used for constructing the filament, filament condition and operating emission current. The product of the filament voltage and current is the power dissipation (V×A) required to maintain the set emission current. The interpretation of these displayed values is a qualitative measure. The values will change over time dependent upon the pressure, filament coating condition and possibly even surface properties of the grid electrode. It is a good practice to make note of these values at initial installation and from time-to-time during the operating lifetime of the ion gauge sensor.

A new ion gauge may operate at 100 µA emission current with only 3.5 A of filament current. By increasing the emission current to 10 mA, the filament current requirement may increase to 4.5 A. Again, the values mentioned here are representative; the actual values you may see for the ion gauge you are using will be different and will vary over time and from device to device. In general, keeping a record of the filament heating power (given by the Filament Voltage and Filament Current readings) will aid you in monitoring the condition of your gauge filaments over time and give you an indication of when to schedule replacement of either the device or the filament assembly. Maximum filament current is 6.5 A.

In cases where the ion gauge sensor does not turn ON or does not stay in the ON condition after you have made sure that the pressure is below the maximum permissible pressure for the emission current setting you have chosen, you will be able to monitor the values displayed in the RESEARCH screen and determine if the turn ON / stay ON trouble is related to filament condition. There are maximum operating levels for filament voltage and current; if either of these is exceeded, the VGC083 control circuitry will sense the condition and force an OFF condition.

The following table (Research - Ion Gauge Diagnostic Display) is intended to assist you in using the information provided in this display as a means to ascertain if the ion gauge head is performing as expected under your vacuum chamber operating conditions. There are various causes of trouble that at times may make it difficult to use a single measurement parameter as an indicator of what the problem is. In general, if you have monitored and recorded the values displayed in the Research Screen over time, you may be able to detect a pattern or trend that, if correlated to a particular failure mode, may prove to be a valuable indication of probable cause.

The values of filament voltage and current presented below are approximate values that one may see in the Research Screen. The representative, average values used in this table may vary depending on the condition of the filament, length of ion gauge cable, and the vacuum chamber environment. The readings taken should be viewed with the notion that there may be an indication of reaching end-of-useful filament lifetime if the power required to sustain emission current continues to increase over time.

Indication	Possible Cause	Possible Solution
Filament voltage values are present for several seconds immediately after turning IG ON, but then the values are zero	Filament is contaminated or filament has reached end-of-useful operating life for required emission current setting	Switch emission current setting from initial setting and re-start the IG; make several attempts to establish emission current at 100 μ A, 4 mA or 10 mA. Switch to second filament or replace ion gauge sensor
All parameters in the RESEARCH screen are zero after IG turn ON is attempted	Failed electronics	Replace or repair the VGC083
IG filament current is greater than 6.5 A	Filament nearing end-of-useful-operating-life	Switch to second filament or replace ion gauge sensor
IG filament voltage is greater than 16 V	Excessive voltage drop in ion gauge cable	The ion gauge cable maybe too long, wire gauge is too small or a defect in the cable or connectors

10.6 Maintenance

In general, maintenance is not required for your INFICON ion gauge module, convection gauge and control unit. Periodic performance checks may be done by comparing the gauge to a known reference standard. When using the head in gases containing contaminants or materials that react with the filaments of the hot cathode ion gauge, periodic degas and switching to the alternate filament from time-to-time is recommended for longest useable head lifetime. When the hot cathode (filament) of the ionization gauge head is at or near end-of-life, head (sensor) replacement is recommended.

Cleaning the VGC083

For cleaning the outside of the unit a slightly moist cloth will usually do. Do not use any aggressive or scouring cleaning agents.

11 Repair

Return defective products to your nearest INFICON service center for repair. INFICON assumes no liability and the warranty is rendered null and void if repair work is carried out by the end-user or by third parties.

12 Accessories

Power supply		Ordering number
	Power supply to VGC083A when used with BAG050 / 051 / 052 / 053	399-710
	Power supply to VGC083A when used with BAG055	399-712
Rack mount adapter		Ordering number
	Rack mount adapter for 19" 2U for one VGC083	399-714
	Rack mount adapter for 19" 2U for two VGC083	399-715
Cables 200 °C BAG050, BAG051		Ordering number
	Cable 3 m / 10 ft, 200 °C, BAG050, BAG051	399-770
	Cable 8 m / 25 ft, 200 °C, BAG050, BAG051	399-771
	Cable 15 m / 50 ft, 200 °C, BAG050, BAG051	399-772
Cables 50 °C BAG050, BAG051		Ordering number
	Cable 3 m / 10 ft, 50 °C, BAG050, BAG051	399-780
	Cable 8 m / 25 ft, 50 °C, BAG050, BAG051	399-781
	Cable 15 m / 50 ft, 50 °C, BAG050, BAG051	399-722
Cables 50 °C BAG052, BAG053		Ordering number
	Cable 3 m / 10 ft, 50 °C, BAG052, BAG053	399-790
	Cable 8 m / 25 ft, 50 °C, BAG052, BAG053	399-791
	Cable 15 m / 50 ft, 50 °C, BAG052, BAG053	399-792
Cables 50 °C BAG055		Ordering number
	Cable 3 m / 10 ft, 50 °C, BAG055	399-810
	Cable 8 m / 25 ft, 50 °C, BAG055	399-811
	Cable 15 m / 50 ft, 50 °C, BAG055	399-812

13 Storage



Caution



Electronic components.

Inappropriate storage (static electricity, humidity etc.) may damage electronic components.

Store the product in an antistatic bag or container. Observe the relevant specifications under Technical Data (→ 10).

14 Disposal



WARNING



Substances detrimental to the environment.

Products or parts thereof (mechanical and electric components, operating fluids etc.) may be detrimental to the environment.

Please dispose of such materials in accordance with the relevant local regulations.

Separating the components

Electronic and non-electronic components

After disassembling the product, separate its components in accordance with the following criteria:

Such components must be separated according to their materials and recycled.

EU Declaration of Conformity



We, INFICON, hereby declare that the equipment mentioned below complies with the provisions of the Directive relating to electromagnetic compatibility 2014/30/EU and the Directive on the restriction of the use of certain hazardous substances in electrical and electronic equipment 2011/65/EU.

Product Vacuum Gauge Controller
VGC083A, VGC083B

Part numbers 399-700
399-701

Standards Harmonized and international/national standards and specifications:

- EN 61000-6-2:2005
(EMC: generic immunity standard for industrial environments)
- EN 61000-6-4:2007 + A1:2011
(EMC: generic emission standard for industrial environments)
- EN 61010-1:2010
(Safety requirements for electrical equipment for measurement, control and laboratory use)
- EN 61326-1:2013; Group 1, Class A
(EMC requirements for electrical equipment for measurement, control and laboratory use)

Manufacturer / Signatures

INFICON AG, Alte Landstraße 6, LI-9496 Balzers

22 November 2016

22 November 2016



Dr. Benhard Andreaus
Director Product Evolution

Markus Truniger
Product Manager

Original: English



tinb29e1-c



*LI-9496 Balzers
Liechtenstein
Tel +423 / 388 3111
Fax +423 / 388 3700
reachus@inficon.com*

www.inficon.com