

Translation of the original operating instructions

# XL3000flex, XL3000flexRC

Leak Detector

Catalog No.  
520-200, 520-201

From software version  
V2.85 (Operating unit)

jina83en1-07-(2105)



INFICON GmbH

Bonner Strasse 498

50968 Cologne, Germany

# Table of Contents

<b>1</b>	<b>About this manual</b>	<b>6</b>
1.1	Other associated documents	6
1.2	Warnings	6
1.3	Target groups	6
<b>2</b>	<b>Safety</b>	<b>7</b>
2.1	Intended use	7
2.2	Duties of the operator	8
2.3	Owner requirements	9
2.4	Dangers	9
<b>3</b>	<b>Scope of delivery</b>	<b>11</b>
<b>4</b>	<b>Description</b>	<b>12</b>
4.1	Function	12
4.2	Operation mode "Sniffing"	13
4.3	Device setup	14
4.4	Sniffer line SL3000XL	18
4.4.1	Device overview	18
4.4.2	Operating elements on the handle	19
4.5	Touchscreen elements	20
4.6	Elements of the error and warning display	23
4.7	Technical data	23
4.8	Factory settings	25
<b>5</b>	<b>Installation</b>	<b>28</b>
5.1	Setup	28
5.2	Connecting the sniffer line	30
5.3	Mounting the I/O module or bus module (optional)	30
5.4	Fasten holder for sniffer line (optional)	31
5.5	XL3000flexRC only: Assemble data cable and CU1000	32
<b>6</b>	<b>Operation</b>	<b>34</b>
6.1	Switching the device on	34
6.2	Basic settings	34
6.2.1	Setting the language	34
6.2.2	Setting date and time	35

6.2.3	Selecting a unit for the leak rate .....	35
6.2.4	Select display unit for pressure.....	36
6.2.5	Select interface unit for pressure .....	36
6.2.6	Settings for the XL sniffer adapter .....	36
6.2.7	Operator types and authorizations.....	39
6.2.7.1	Logging out the operator .....	40
6.2.8	Setting the audio alarm .....	41
6.2.9	Cathode Selection.....	41
6.2.10	Changing the display of the axes.....	42
6.2.11	Changing the display of measured values .....	43
6.2.12	Displaying Calibration Instructions.....	43
6.2.13	Show calibration request.....	43
6.2.14	Show warnings.....	43
6.2.15	Automatic switch-off of the touchscreen .....	44
6.2.16	Changing the display brightness.....	44
6.2.17	Show setpoint .....	44
6.2.18	Assigning favorite buttons.....	44
6.2.19	Selecting the type of expansion module .....	45
6.2.20	General interface settings (I/O module).....	45
6.2.21	Assigning analog outputs of the I/O module .....	46
6.2.22	Assigning the digital inputs of the I/O module.....	49
6.2.23	Assigning the digital outputs of the I/O module.....	51
6.2.24	Settings for bus module BM1000.....	53
6.2.25	Operation mode "Sniffing" .....	53
6.3	Settings for the measurements.....	55
6.3.1	Select gas type (mass) .....	55
6.3.2	Display equivalence leak rate for other gas.....	55
6.3.2.1	Gas equivalent selection .....	56
6.3.2.2	Configure gas list .....	56
6.3.2.3	Calculate equivalence factor .....	57
6.3.2.4	Set equivalence factor and molar mass.....	58
6.3.3	Setting setpoints .....	59
6.3.4	Calibrating the device .....	60
6.3.4.1	Time and general preferences .....	60
6.3.4.2	External Calibration Configuration and Start.....	61

6.3.4.3	Check the calibration.....	63
6.3.4.4	Calibration using the external calibration leak test.....	63
6.3.4.5	External calibration with sniffer line SL3000XL.....	64
6.3.4.6	Automate external calibration with CalMate (optional).....	65
6.3.4.7	Entering the calibration factor .....	66
6.3.4.8	Calibration factor sniffing.....	66
6.3.5	Suppressing gas backgrounds with "ZERO" functions .....	67
6.4	Measuring.....	69
6.5	Measurement result display with signal filters .....	69
6.6	Recording data .....	71
6.7	Copying measurement data, deleting measurement data.....	72
6.8	Updating the software.....	72
6.8.1	Updating the software of the control unit .....	72
6.8.2	Updating the software of the I/O module .....	73
6.9	Calling up information.....	74
6.10	Display, save, load parameters .....	77
6.11	Resetting the settings .....	78
<b>7</b>	<b>Warning and error messages .....</b>	<b>79</b>
<b>8</b>	<b>Cleaning and maintenance.....</b>	<b>87</b>
8.1	Cleaning the housing .....	87
8.2	Maintenance of the XL3000flex .....	87
8.2.1	Change the filter mat of the fan input.....	87
8.2.2	Replacing the fuses .....	88
8.2.3	Replacing the filter cartridge on the sniffer probe .....	88
8.2.4	Sending for repair or maintenance.....	90
8.2.5	Maintenance plan.....	90
<b>9</b>	<b>Decommissioning the measuring instrument.....</b>	<b>91</b>
9.1	Sending in the device .....	91
<b>10</b>	<b>Gas library .....</b>	<b>93</b>
<b>11</b>	<b>Accessories .....</b>	<b>101</b>
<b>12</b>	<b>CE Declaration of Conformity .....</b>	<b>102</b>
<b>13</b>	<b>RoHS.....</b>	<b>103</b>
	<b>Index.....</b>	<b>104</b>

# 1 About this manual

This document applies to the software version stated on the title page.

Product names may occur in the document, which are added for identification purposes only and belong to the respective owner of the rights.

## 1.1 Other associated documents

Interface protocols	jira54
Bus module BM1000	jiqb10
I/O module IO1000	jiqc10

## 1.2 Warnings

### DANGER

Imminent hazard resulting in death or serious injuries

### WARNING

Hazardous situation resulting in potential death or serious injuries

### CAUTION

Hazardous situation resulting in minor injuries

### NOTICE

Hazardous situation resulting in damage to property or the environment

## 1.3 Target groups

These operating instructions are intended for the owner and for technically qualified personnel with experience in leak detection technology and integration of leak detection devices in leak detection systems. In addition, the installation and use of the device require knowledge of electronic interfaces.

## 2 Safety

### 2.1 Intended use

The XL3000flex is a helium or hydrogen leak detector for sniffing detection. With the device you locate and quantify leaks on test objects.

A test object always contains gas under overpressure. Check the exterior of the test objects for escaping gas using a sniffer line (sniffing method).

- Operate the device only according to this instruction manual.
- Comply with application limits, see "Technical Data".

#### Misapplications

Avoid the following, non-intended uses:

- Use outside the technical specifications, see "Technical Specifications"
- Use in radioactive areas
- Using the device with detectable defects or defective power switch
- Use of accessories or spare parts, which are not included in this instruction manual
- Test of wet or damp test objects
- Sniffing of explosive, aggressive, corrosive, flammable, toxic or reactive substances
- Sniffing of condensable fluids and vapors
- Sniffing of gases contaminated with particles
- Using the sniffer line handle over a long period of time, leading to fatigue.
- Sniffing of gases above the lower explosion limit. The allowable composition of venal gas mixtures can be read in the safety data sheets of the respective manufacturers.
- Using the device in potentially explosive atmospheres
- Aspirate liquids into the device via the sniffer line
- Operation at too high ambient temperature
- Inspecting electrically live conductors or objects with a sniffer line
- Using the device as a seat or step
- Raising the device with the handles when the feet are facing up. Otherwise your hands may get trapped.
- Inserting the sniffer tip into body orifices.

## 2.2 Duties of the operator

- Read, observe, and follow the information in this manual and in the work instructions provided by the owner. This concerns in particular the safety and warning instructions.
- Always observe the complete operating instructions for all work.
- If you have any questions about operation or maintenance that are not answered in this manual, contact customer service.



## 2.3 Owner requirements

The following notes are for companies or any person who is responsible for the safety and effective use of the product by the user, employee or third party.

### Safety conscious operation

- Operate the device only if it is in perfect technical condition and has no damage.
- Only operate the device in accordance with this instruction manual, in a safety and risk conscious manner.
- Adhere to the following regulations and observe their compliance:
  - Intended use
  - General applicable safety and accident prevention regulations
  - International, national and local standards and guidelines
  - Additional device-related provisions and regulations
- Only use original parts or parts approved by the manufacturer.
- Keep this instruction manual available on site.

### Personnel qualifications

- Only have qualified personnel make the basic settings on the device. The handling of the sniffer line can also be done by laymen according to instructions.

## 2.4 Dangers

The measuring instrument was built according to the state-of-the-art and the recognized safety regulations. Nevertheless, improper use may result in risk to life and limb on the part of the user or third parties, or damage to the unit or other property may occur.

### Hazards due to liquids and chemicals

Liquids and chemical substances can damage the instrument.

- Comply with application limits, see "Technical Data".
- Do not suck up liquids with the instrument.
- Avoid sniffing gases, such as hydrogen, above the lower explosion limit. The allowable composition of venal gas mixtures can be read in the safety data sheets of the respective manufacturers.
- Only use the device away from areas with a risk of explosions.

### Dangers from electric power

There is a danger to life from the contact of conductive parts inside the device.

- Disconnect the device from the power supply prior to any installation and maintenance work. Make sure that the electric power supply cannot be reconnected without authorization.

The device contains electric components that can be damaged from high electric voltage.

- Before connecting the device to the power supply, make sure that the supply voltage specified on the device is the same as the local power supply.

## 3 Scope of delivery

Item	Quantity
XL3000flex or XL3000flexRC <sup>1)</sup>	1
USB stick (instruction manuals and short instructions in all available languages)	1
Filter set for fans	2
Set of fuses	1
Power supply cable USA	1
Power supply cable UK	1
Power supply cable JP	1
Power supply cable EU	1
Goods issue inspection log	1
Touch PIN	1
Short instruction	1

1) XL3000flexRC in standard scope of delivery without data cable and CU1000 control unit. Both are required for the described function. See also "Accessories [▶ 101]".

- ▶ Check the delivery contents after receiving the product to ensure it is complete.



### Necessary accessories for operation

For operating the XL3000flex you need a sniffer line SL3000XL. It is available in various lengths:

- SL3000XL XL, length 3 m, order number 521-011
- SL3000XL XL, length 5 m, order number 521-012
- SL3000XL XL, length 10 m, order number 521-013
- SL3000XL XL, length 15 m, order number 521-014

Further accessories see "Accessories [▶ 101]".

- ▶ Always store the device in compliance with the technical data, see Technical data [▶ 23].

## 4 Description

### 4.1 Function

The XL3000flex is a detection device for the tracer gases helium and hydrogen.

The device is designed for leak detection with the SL3000XL sniffer line, which is available in different lengths. With this sniffer line, you can detect leaks at a greater distance (high Flow) from the suspected leak if the detection limit has deteriorated and switch to low flow for more accurate localization.

Digital data can be exchanged via the optionally available I/O module IO1000 or bus module BM1000.

## 4.2 Operation mode "Sniffing"

The XL3000flex has been developed exclusively for the "sniffing" mode. For operating you need a sniffer line SL3000XL. It is available in various lengths, see "Scope of delivery and additional equipment".

The sniffer line SL3000XL is connected to the connection provided on the front of the device, see "Device setup [▶ 14]".

### Sniffer line SL3000XL

	SL3000XL
Detection limit	$< 2 \times 10^{-7}$ mbar l/s
Gas flow (low flow / high flow)	(300 sccm / 3000 sccm)
Available lengths	3 / 5 / 10 / 15 m
Cable sleeve	Plastic
Good-Bad-Display	YES
ZERO via button	YES
Connection on the device	via a separate sleeve on the front of the device
Display with measurement view	YES
Acknowledge faults via buttons on the sniffer probe	YES
End standby via a button on the sniffer probe	YES
Acknowledge calibration via a button on the sniffer probe	YES

## 4.3 Device setup

### XL3000flex: Front view

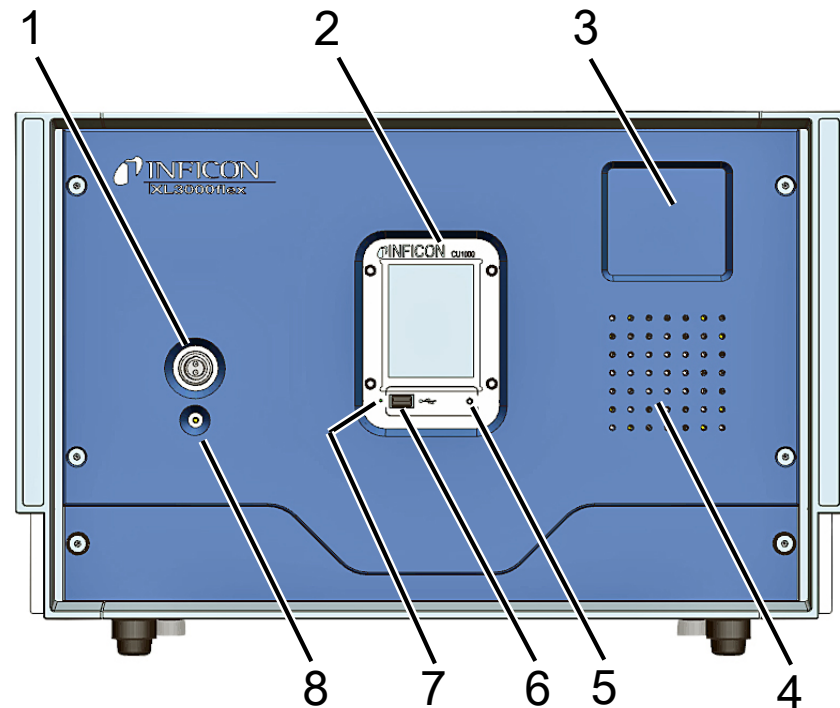

1	Connection for sniffer line SL3000XL	5	Status LED of the operating unit. Shines: Control unit operates normally Flashes: Display in power saving mode
2	Touchscreen	6	Connection for USB stick
3	Area for fixing a holder for the sniffer line	7	Reset button, can be triggered by key PIN
4	Speaker	8	Status LED A permanently lit status LED shows that the sniffer line is supplied with voltage.

**XL3000flexRC: Front view**

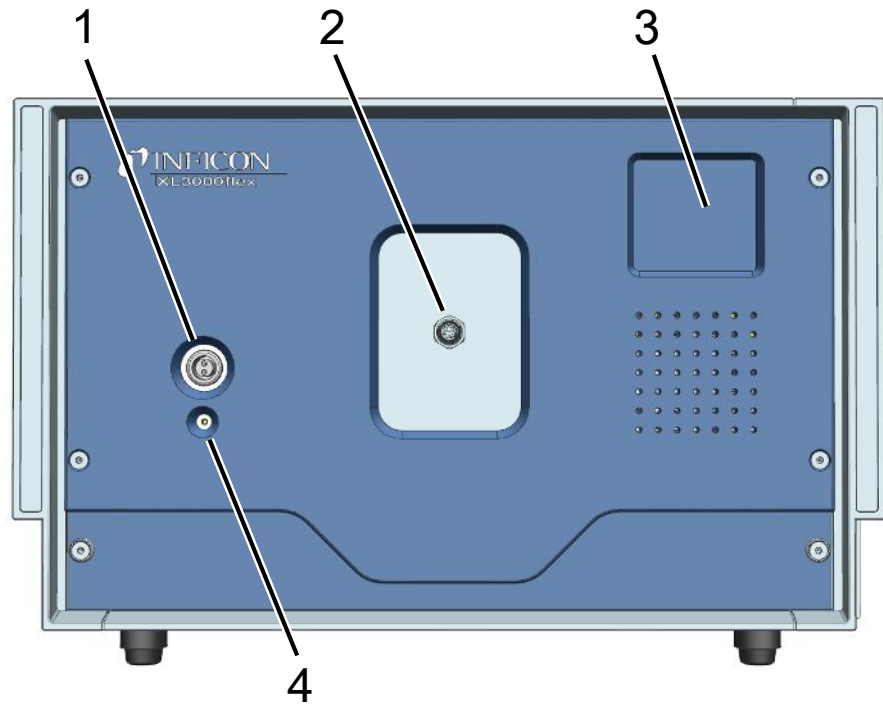

1	Connection for sniffer line SL3000XL	4	Status LED A permanently lit status LED shows that the sniffer line is supplied with voltage.
2	Interface for a data cable for connection to an external control unit CU1000. See also "XL3000flexRC only: Assemble data cable and CU1000 [ 32]".		
3	Area for fixing a holder for the sniffer line		

## Back view

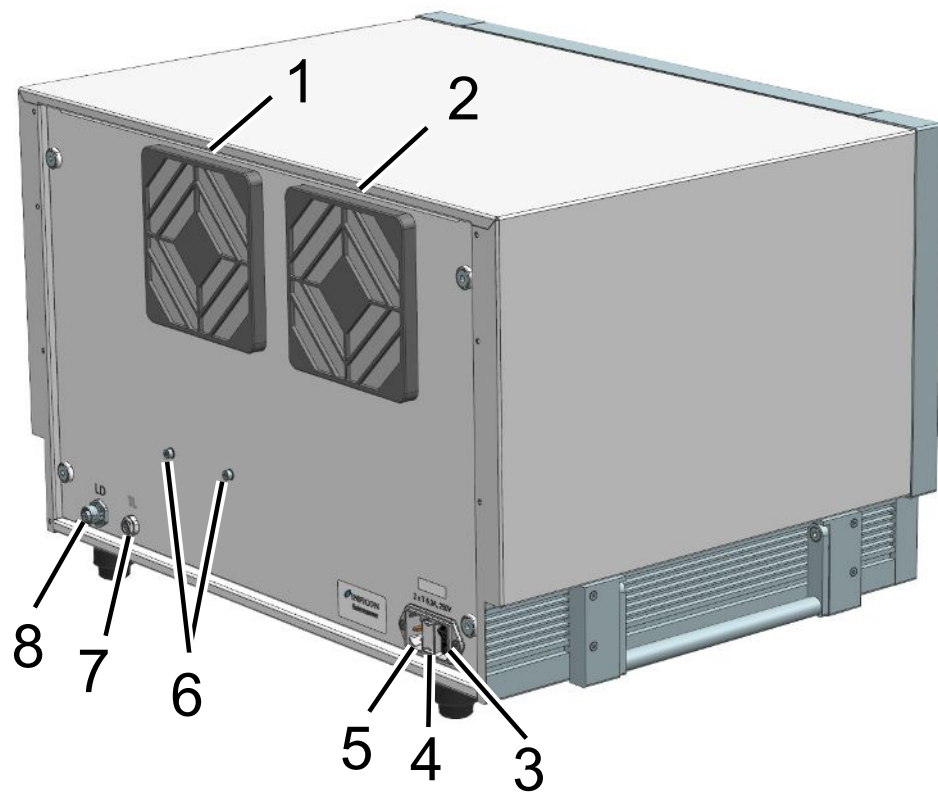

1	Filter ventilator inlet	5	Power cable connection
2	Filter ventilator inlet	6	Mounting screws for a profile rail (for mounting the I/O module IO1000 or the bus module, optional)
3	Device power ON/OFF switch	7	Connection "TL" for connection cable to calibration adapter for calibration leaks
4	Electrical fuse	8	Connection "LD" for the data cable of the I/O module or bus module



View from below

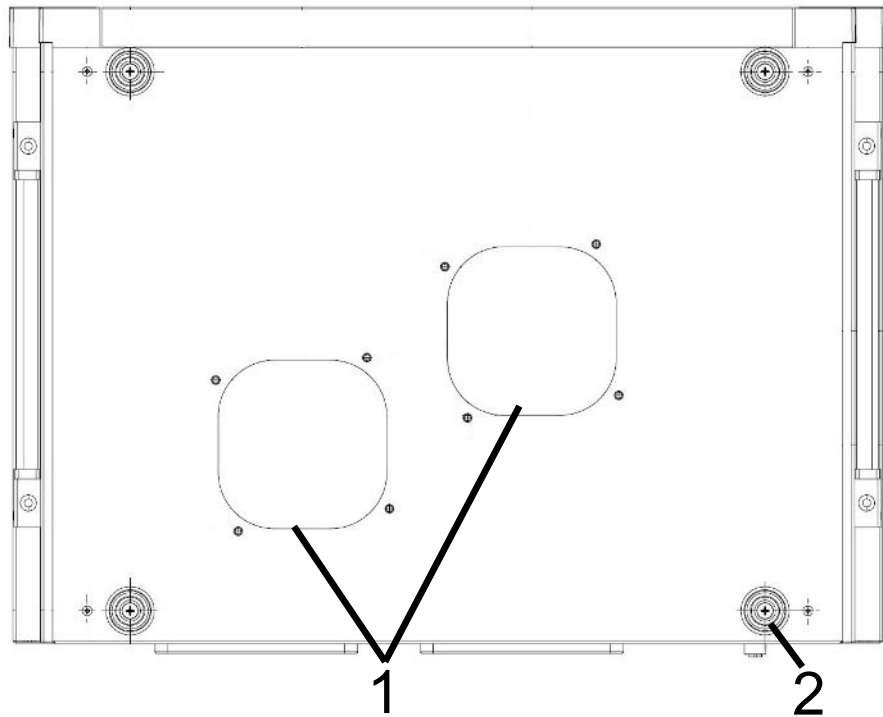

- |   |                    |   |                        |
|---|--------------------|---|------------------------|
| 1 | filter fan outputs | 2 | Rubber feet (4 pieces) |
|---|--------------------|---|------------------------|

Side handles for transportation

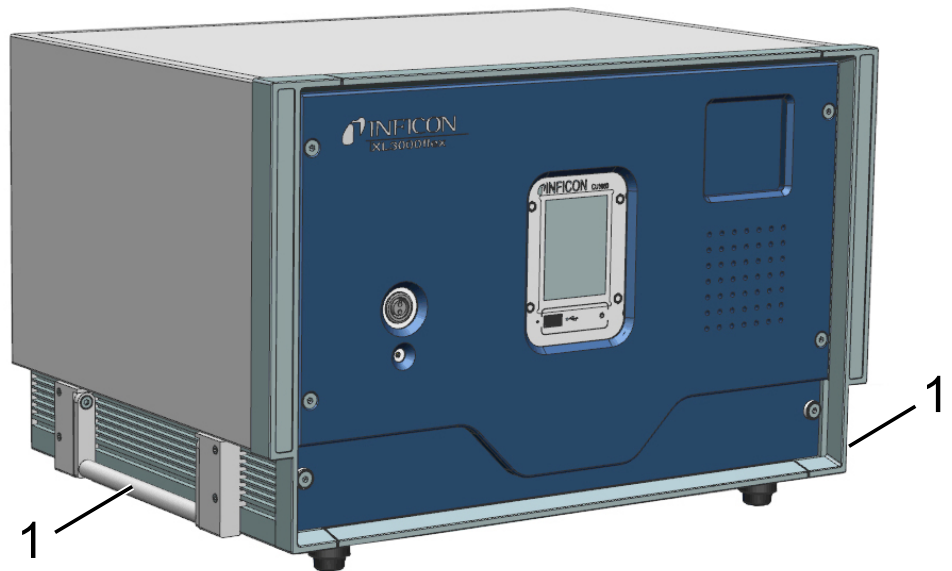

- |   |                   |
|---|-------------------|
| 1 | Transport handles |
|---|-------------------|



Do not open the device!

## 4.4 Sniffer line SL3000XL

### 4.4.1 Device overview

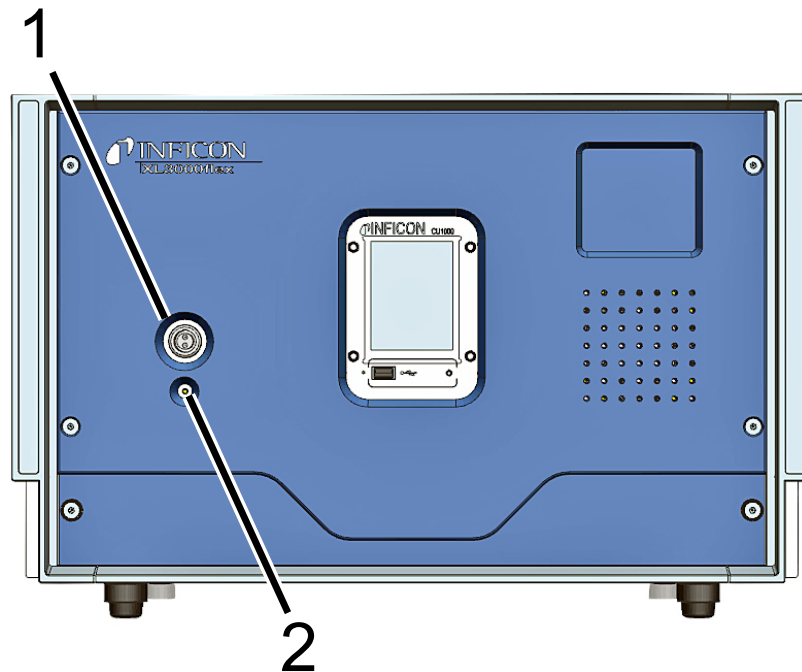

1 Connection SL3000XL, connection for the sniffer line on the front

2 The status LED indicates the operating status. A permanently lit status LED shows that the sniffer line is supplied with voltage.



#### Necessary accessories for operation

For operating the XL300flex you need the sniffer line SL3000XL. It is available in different lengths (see Scope of delivery and additional equipment).

#### See also

📄 Connecting the sniffer line [▶ 30]

## 4.4.2 Operating elements on the handle

The display of the handle displays part of the information of the main display.



Fig. 1: Sniffer line SL3000XL

The leak rate is shown as a bar graph and displayed numerically. The unit of measurement is the same as in the main display.

The display also shows the gas type and the tracer gas concentration. If the XL3000flex is operated in the high flow operation mode, then the gas type display has a dark background.

Warning or error messages are shown on the display. The message is confirmed with the right button. The right button can otherwise be used to switch between low flow and high flow.

The left button can be used for a ZERO-adjustment: The background display is set toZERO by pressing the key.

The sniffer probe is equipped with LEDs for work in dimly lit places.

---

### **WARNING**

#### **Danger of eye damage or headaches**

LEDs generate a bundled light that can damage your eyes.

- ▶ Do not look into the LEDs from a short distance or for longer periods of time.
-

## 4.5 Touchscreen elements

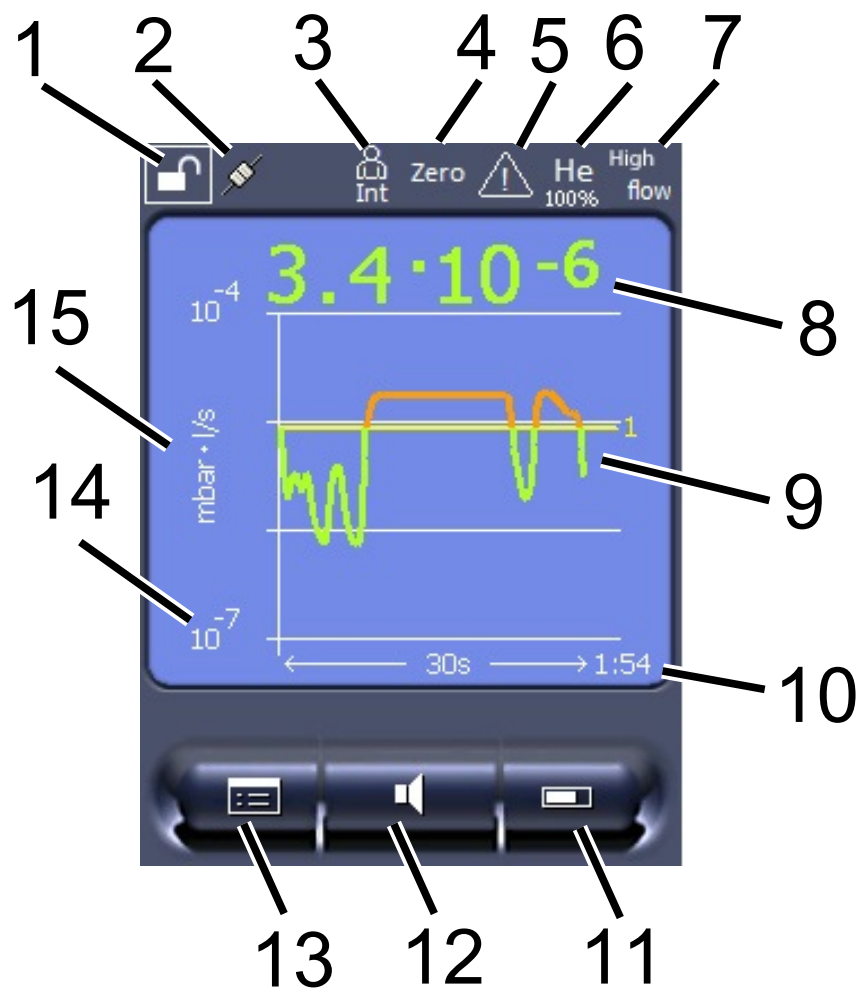

Fig. 2: Measurement display

1	Keyboard lock	2	Communication status	3	Operator
4	ZERO	5	Message	6	Tracer gas
7	Operation mode	8	Leak rate with peak hold function	9	Graphic representation of the leak rate and the peak hold function
10	Time axis	11	Button "Favorite 2"	12	Button "Favorite 1"
13	Menu	14	Value axis	15	Value axis

### 1 - Keyboard lock

The control unit is locked or unlocked by pressing and holding the icon for the keyboard lock.

### 2 - Icon for the communication status

- Icon connected: The device communicates with the mass spectrometer module.

- Icon disconnected: The device does not communicate with the mass spectrometer module.
- To reset the control unit, press the reset button with the key PIN, see also "Device setup [► 14]", first illustration.

### 3 - Operator

The registered operator is shown abbreviated.

Display	Meaning
Ope	Operator
Sup	Supervisor
Int	Integrator
Ser	Service

### 4 - ZERO

Background suppression is active.

### 5 - Caution icon

Active warnings are stored in the unit.

The active warnings can be displayed via the menu "Info > History > Warnings".

### 6 - Tracer gas

Set tracer gas and tracer gas concentration percentage.

Display	Meaning
He	Helium ( <sup>4</sup> He)
H2	Hydrogen
M3	E.g. H-D, <sup>3</sup> He or H <sub>3</sub>

### 7 - Operation mode

Configured operation mode

Display	Operation mode
LOW FLOW	XL sniffer adapter in LOW FLOW
HIGH FLOW	XL sniffer adapter in HIGH FLOW

### 8 - Leak rate

Current measurement for the leak rate.

## **9 - Graph**

Graphic display of the leak rate  $Q(t)$ .

## **10 - Leak rate**

Time axis of the leak rate  $Q(t)$ .

## **11 - Button "Favorite 2"**

You can assign preferred parameters to this key.

## **12 - Button "Favorite 1"**

You can assign preferred parameters to this key.

## **13 - Icon for the menu**

All functions and parameters of the control unit can be accessed using the "Menu" key .

A full representation of the menu is included on the supplied USB stick.

## **14 - Value axis**

Value axis of the leak rate  $Q(t)$ .

## **15 - Device of measurement**

Device of measurement of the value axis.

## 4.6 Elements of the error and warning display

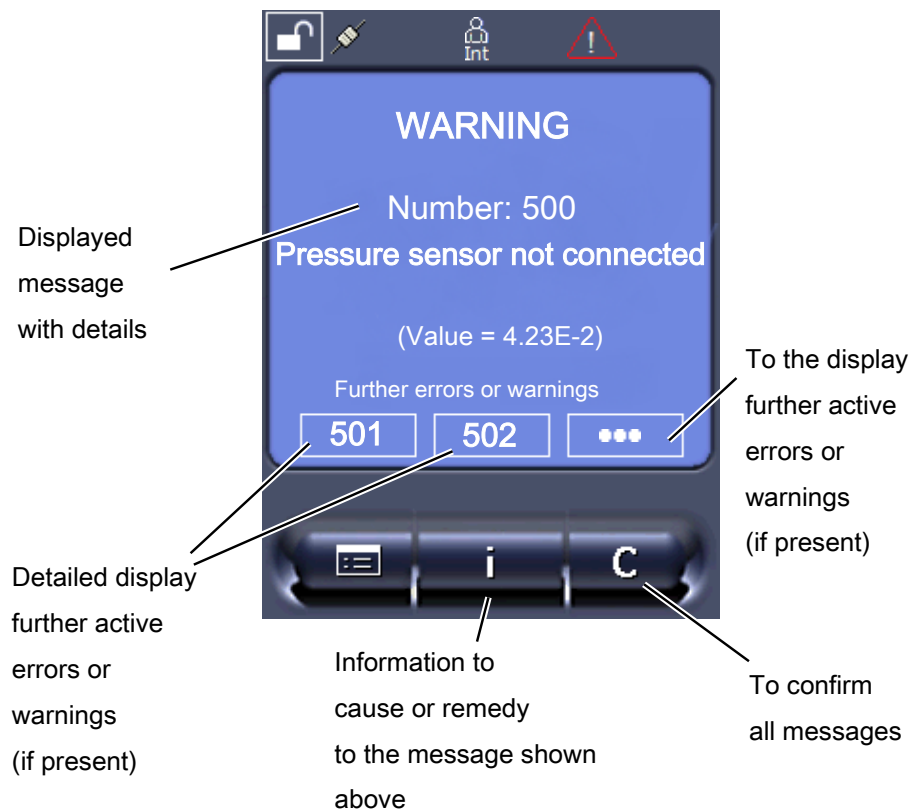

## 4.7 Technical data

### Mechanical data

XL3000flex	
Dimensions (L × W × H)	544 x 404 x 358 mm
Weight	37.5 kg

XL3000flexRC	
Dimensions (L × W × H)	544 x 404 x 358 mm
Weight	36.5 kg

### Electrical data

XL3000flex, XL3000flexRC	
Power	280 VA
Operating voltage	100 - 240 V, 50 / 60 Hz

XL3000flex, XL3000flexRC	
Main fuse	2x T6,3 A 250 V
Protection class	IP 30
Overvoltage category	II

## Physical data

XL3000flex, XL3000flexRC	
Run-up time	150 s
Detectable gases	Helium, hydrogen
Detectable masses	<sup>4</sup> He, H <sub>2</sub> , Mass 3 (e.g. H-D, <sup>3</sup> He or H <sub>3</sub> )
Ion source	2 longlife Iridium filaments, Yttrium-oxide coated
Gas flow <sup>1</sup>	
• High flow	3000 sccm
• Low flow	300 sccm
Minimum detectable leak rate (MDLR)	
• Helium	
• High flow	2 x 10 <sup>-6</sup> mbar l/s
• Low flow	2 x 10 <sup>-7</sup> mbar l/s
• Forming gas (95/5)	
• High flow	2 x 10 <sup>-6</sup> mbar l/s
• Low flow	2 x 10 <sup>-7</sup> mbar l/s
Response time	
• High flow	< 1 s
• Low flow	< 1 s
The A-weighted emission sound pressure level at the operator's location is less than 70 dB (A) for all foreseeable uses of the device. The noise emission measurement declaration was drawn up in accordance with the harmonized standard DIN EN ISO 3744:2011.	

<sup>1</sup> Measured at 1 atm (1013 mbar) at sea level. The gas pressure changes with atmospheric pressure and thus also with the geographical altitude.



## Ambient conditions

XL3000flex, XL3000flexRC	
Permissible ambient temperature (during operation)	10 °C ... 40°C
Max. altitude above sea level	2000 m
Max. relative humidity ≤ 31°C	80 %
Max. relative humidity > 31°C	50 %
Storage temperature	-20 °C ... 60°C
Degree of contamination	2

## 4.8 Factory settings

The following table shows the factory settings in the "Sniffing" mode.

Parameter	Factory setting
AO upper limit exp.	$1 \times 10^{-5}$
Equivalent factor mass 2 (H2)	1.0
Equivalent factor mass 3	1.0
Equivalent factor mass 4 (He)	1.0
Molar mass of the equivalence gas (test gas mass 2 (H2))	2.0
Molar mass of the equivalence gas (test gas mass 3)	3.0
Molar mass of the equivalence gas (test gas mass 4 (He))	4.0
Operation mode	XL Sniffer Adapter
Bus module address	126
Pressure capillary blocked (Low Flow)	0.2 mbar
Pressure capillary broken (Low Flow)	0.6 mbar
Clogged pressure capillary monitoring - with XL Sniffer Adapter (High Flow)	150 mbar
Broken pressure capillary monitoring - with XL Sniffer Adapter (High Flow)	400 mbar
Pressure unit (interface)	mbar
Emission	On
Filter leak rate threshold	$1 \times 10^{-10}$

Parameter	Factory setting
Filter ZERO time	5 s
Filter mode	I-Filter
Gas percentage in H <sub>2</sub> (M3, He)	5 % H <sub>2</sub> , 100 % M3, 100% He
Gas ballast	Off
I/O module log	ASCII
Calibration request	On
Calibration factor VAC/SNIF Mx (for vacuum, sniffing and all masses)	1.0
Cathode selection	Auto Cat1
Compatibility mode	XL Sniffer Adapter
Config. Analog output 1	Leak rate mantissa
Config. Analog output 2	Leak rate exponent
Config. Analog output scaling	0.5 V / decade
Configuration of digital outputs	Pin 1: Trigger 1, inverted Pin 2: Trigger 2, inverted Pin 3: Trigger 3, inverted Pin 4: Trigger 4, inverted Pin 5: Ready Pin 6: Error, inverted Pin 7: CAL request, inverted Pin 8: Open, inverted
Configuration of digital Inputs	Pin 1: Select dyn. / normal CAL Pin 2: Sniff Pin 3: Start/Stop, inverted Pin 4: ZERO Pin 5: External CAL Pin 6: Internal CAL Pin 7: Clear Pin 8: ZERO update Pin 9: – Pin 10: –
Leak rate unit SNIF, (display and interface)	mbar l/s
Leak rate unit VAC, (display and interface)	mbar l/s
Leak rate upper limit VAC (interface)	1.0 x 10 <sup>4</sup>
Leak rate lower limit VAC (interface)	1.0 x 10 <sup>-12</sup>
Leak rate upper limit SNIF (interface)	1.0 x 10 <sup>4</sup>
Leak rate lower limit SNIF (interface)	1.0 x 10 <sup>-8</sup>
Fan mode	Fan always on
Machine factor in standby	Off

Parameter	Factory setting
Machine factor / Sniff factor	1.0 (for all masses)
Mass	4
Module on the I/O connection	IO1000
Nominal state TMP	On
calibration leak external SNIF	$9.9 \times 10^{-2}$
calibration leak external VAC	$9.9 \times 10^{-2}$
calibration leak internal	$9.9 \times 10^{-2}$
Open calibration leak internal	Off
Sniffer line detection	On
Sniffer LED Alarm Configured	Flashing
Sniffer light brightness	5
Sniffer beep	Trigger
Sniffer button Flow	On
Sniffer key ZERO	On
Language	English
Muting the beep	Off
TMP rotation speed	1000
Trigger level 1 (2, 3, 4)	$2 \times 10^{-4}$ mbar l/s ( $1 \times 10^{-5}$ ) mbar l/s
Preamplifier test at CAL	On
Maintenance warning	TMP and diaphragm pump
ZERO with start	On
ZERO mode	Suppress everything

## 5 Installation

The structure of the device, see “Device setup [▶ 14]”.

### 5.1 Setup

#### CAUTION

##### **Risk of injury from lifting the heavy device**

The device weighs approx. 37 kg and can slip out of your hands.

- ▶ Lift and transport the device only with persons who are physically able to do so.
- ▶ Lift and transport the device at least in pairs.
- ▶ To lift, grasp the handle grips on the sides of the device.
- ▶ To avoid crushing the hands, the feet of the device must not point upwards when it is lifted or transported.
- ▶ The device must not be lifted and transported with just one handle.

#### CAUTION

##### **Risk of injury due to improper installation**

If the device is not placed on a flat, non-slip surface, it may fall and cause personal injury or property damage.

- ▶ Place the device on a level, slip-proof work area.

#### NOTICE

##### **Material damage from overheated device**

The device heats up during operation and can overheat without sufficient ventilation.

- ▶ Please note the technical data.
- ▶ Ensure sufficient ventilation, especially on the ventilation slots on the rear and bottom: There should be free space in the front, to the rear and sides of the unit of at least 20 cm.
- ▶ Device should be placed on a flat surface to ensure proper air intake from the bottom of the device.
- ▶ Keep heat sources away from the device.

**⚠ WARNING****Danger from moisture and electricity**

Moisture entering the device can lead to personal injury due to electric shocks as well as damage to property due to short circuiting.

- ▶ Only operate the device in dry environments and only in buildings.
- ▶ Operate the device away from sources of liquid and moisture.
- ▶ Position the device so that you can always reach the power plug to unplug the device.
- ▶ Do not operate the device in standing water and do not allow even a drop of water or other liquid on the device.
- ▶ Prevent the device from coming into contact with bases, acids and solvents.

**⚠ WARNING****Danger from electric shock**

Improperly grounded or fused products may be dangerous to life in case of a fault. The use of the device is not permitted without a connected protective conductor.

- ▶ Only use the included 3-wire power cable.
- ▶ Make sure that the power supply plug is always accessible.

**NOTICE****Damage to the turbo molecular pump due to jerking movements**

Jerking movements can damage the running turbo molecular pump.

- ▶ Avoid any jerking movements or vibrations to the device during operation and for up to 2 minutes after switching off.

- Place the device on a level, slip-proof work area.
- Prevent tripping hazards when placing the device and connecting lines.

## 5.2 Connecting the sniffer line

Connect the sniffer line before you start up the device.

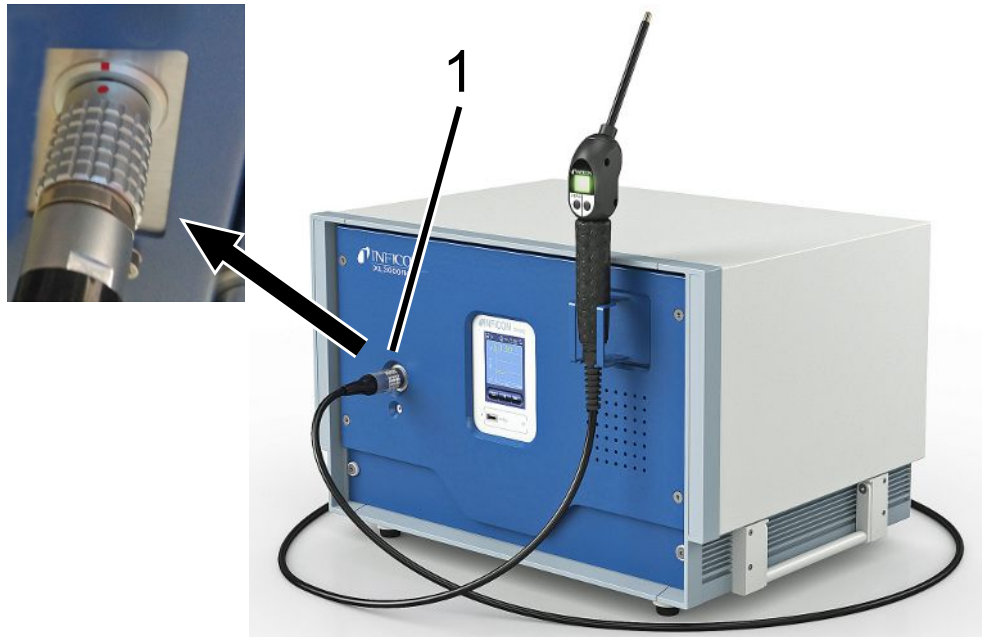

### 1 Connection for sniffer line

- 1 Align the red marking on the sniffer line plug with the red marking on the socket of the device.
- 2 Push the sniffer line plug into the socket on the device until it locks into place. The plug may no longer be easy to move.

## 5.3 Mounting the I/O module or bus module (optional)

Both modules are interfaces for controlling the leak detector XL3000flex.

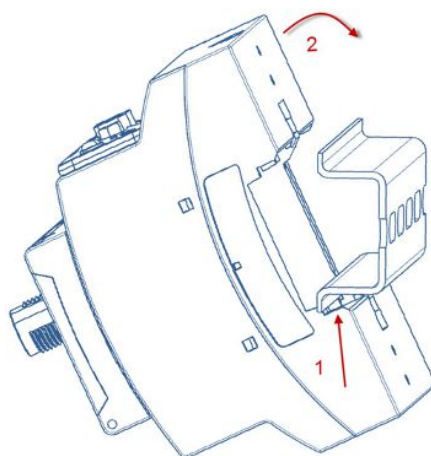

- ✓ You have a separately available I/O module or bus module. See also "Accessories [▶ 101]".
- ✓ You have a commercially available DIN-TS35 DIN rail.
  - 1 Place the sniffer leak detector at least 20 cm away on all sides.
  - 2 Connect the SL3000XL sniffer cable to the front of the XL3000flex.
  - 3 Fasten the DIN rail using the screws already located in the threaded holes on the back of the device (see Device setup [▶ 14]).
  - 4 Then hook the module into the DIN rail at the bottom, press it against the DIN rail at the top and let it snap into place.
  - 5 Connect the I/O module or the bus module via a data cable to the LD socket on the back of the XL3000flex.

**See also**

- 📖 Selecting the type of expansion module [▶ 45]
- 📖 Assigning analog outputs of the I/O module [▶ 46]
- 📖 Settings for bus module BM1000 [▶ 53]

## 5.4 Fasten holder for sniffer line (optional)

### WARNING

#### **Danger to pacemaker wearers from magnets**

The function of a pacemaker can be influenced by the magnet on the back of the holder.

- ▶ If you wear a pacemaker, do not install it yourself.
- ▶ If you wear a pacemaker, always maintain a distance of at least 10 cm from the holder when operating the device.

### CAUTION

#### **Risk of injury due to sniffer tip**

- ▶ To prevent injury from accidental contact with the sniffer tip, align the sniffer tip in the holder so that it points away from the operator.

A bracket is available for the sniffer tip. The holder can be mounted on the front of the device, see also "Device setup [▶ 14]".

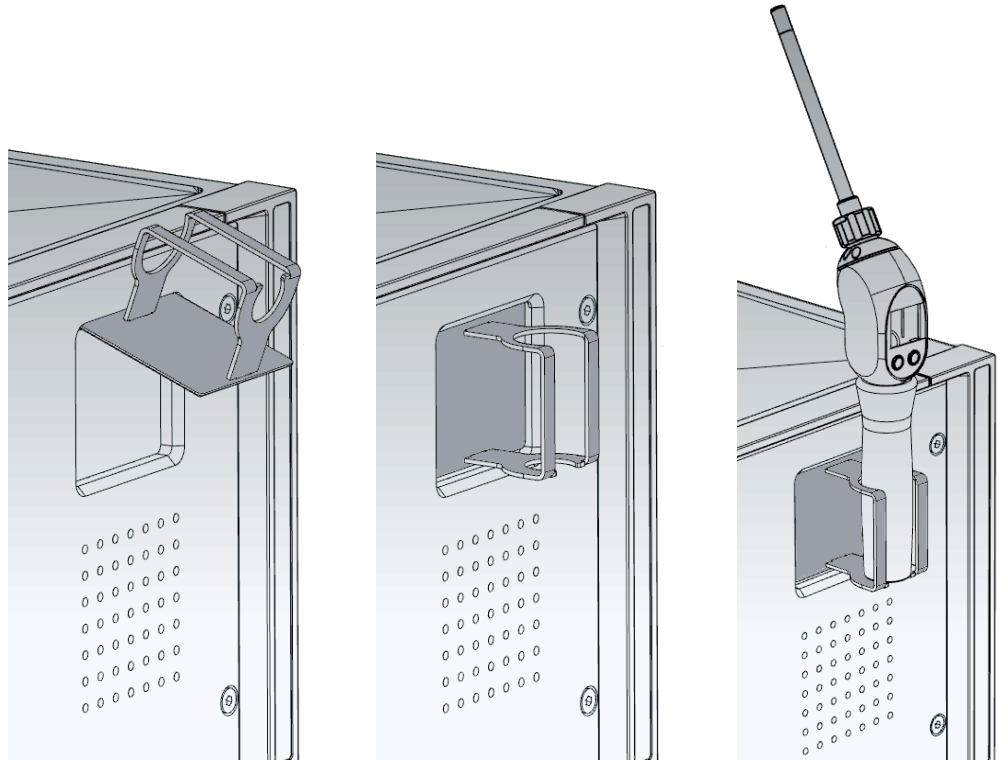

- 1** Hang the holder with its hooks in the slots on the front of the device.
- 2** Press the holder against the front panel of the device.  
⇒ The holder is pulled to the front panel of the device with a magnet on its rear.
- 3** When not in use, fix the sniffer line in the holder so that it points away from the operator.

## 5.5 XL3000flexRC only: Assemble data cable and CU1000





- ▶ Connect the leak detector and the separate CU1000 via a data cable. Use the interface on the front of the device for this purpose.



### **Accessories required**

The XL3000flexRC is delivered in the standard scope of delivery without data cable and CU1000 control unit. Both are required for the described function.

See also "Accessories [▶ 101]" and the operating instructions for the CU1000 control unit.

---

## 6 Operation

### 6.1 Switching the device on

- ▶ Turn on the XL3000flex via the power switch on the back of the device, see “Device setup [▶ 14]“.
- ⇒ The system is starting automatically.
- ⇒ After the start-up, the green LED on the front cover of the XL3000flex lights up.

### 6.2 Basic settings

The device is assembled and preconfigured so that basic settings have already been made.

To check or change settings, first take a look at the factory defaults. See factory settings of the XL3000flex (Factory settings [▶ 25]).

#### 6.2.1 Setting the language

Select the display language. The factory setting is English. (The display on the handle of the SL3000XL sniffer line shows messages in English instead of in Russian and Chinese.)

German  
English  
French  
Italian  
Spanish  
Portuguese  
Russian  
Chinese  
Japanese

Control unit	Main Menu > Settings > Setup > Control unit > Language
LD protocol	Command 398
ASCII protocol	*CONFig:LANG

## 6.2.2 Setting date and time

Setting the date	
Format: DD.MM.YY	
Control unit	Main Menu > Settings > Date/Time > Date
LD protocol	Command 450
ASCII protocol	*HOUR:DATE
Setting the time	
Format: hh: mm	
Control unit	Main Menu > Settings > Date/Time > Time
LD protocol	Command 450
ASCII protocol	*HOUR:TIME

## 6.2.3 Selecting a unit for the leak rate

### Leak rate unit display

Selecting the leak rate unit in the display for sniffing	
0	mbar l/s (factory setting)
1	Pa m <sup>3</sup> /s
2	atm cc/s
3	Torr l/s
4	ppm
5	g/a
6	oz/yr
7	sccm
8	sft <sup>3</sup> /yr
Control unit	Main Menu > Display > Units (Display) > Leak Rate Unit SNIF
LD protocol	Command 396 (sniffing)
ASCII protocol	Command *CONFig:UNIT:SNDisplay

### Leak rate unit interface

Selecting the leak rate unit of the interfaces for sniffing	
0	mbar l/s (factory setting)
1	Pa m <sup>3</sup> /s
2	atm cc/s
3	Torr l/s
4	ppm

5	g/a
6	oz/yr
7	sccm
8	sft <sup>3</sup> /yr
Control unit	
Settings > Set up > Interfaces > Units (interface) > Leak rate unit SNIF	
LD protocol	
Command 432 (sniffing)	
ASCII protocol	
Command *CONFig:UNIT:LRSnif	

## 6.2.4 Select display unit for pressure

Device of pressure	
mbar	atm
Pa	Torr
Control unit	
Main menu > Display > Units (display) > Pressure unit	

## 6.2.5 Select interface unit for pressure

### Pressure unit interface

Selecting the pressure device of the interfaces	
0	mbar (factory setting)
1	Pa
2	atm
3	Torr
Control unit	
Main Menu > Settings > Setup > Interfaces > Units (Interface) > Pressure Unit	
LD protocol	
Command 430 (sniffing)	
ASCII protocol	
Command *CONFig:UNIT:Pressure	

## 6.2.6 Settings for the XL sniffer adapter

For operation with the XL Sniffer Adapter you have to use the

- SL3000XL sniffer line,
- Select the "XL Sniffer Adapter" operation mode, see "Operation mode "Sniffing" [▶ 53]".

**Function of right sniffer key**

Activate or deactivating the right key of the SL3000XL sniffer line (switching between low flow and high flow). Deactivating the key prevents an inadvertent influencing of the measurement.

Control unit	Settings > Set up > Operation modes > Sniff > Sniffer > Keys > Sniffer flow key
LD protocol	Command 415
ASCII protocol	Command *CONFig:HFButton

**Search Function**

When the search function is activated, the alarm is automatically connected to Trigger 2 as soon as it is switched to High Flow.

- Switched-off Search Function: Alarm, when Trigger 1 is exceeded.
- Switched-on Search Function and operation in Low Flow: Alarm, when Trigger 1 is exceeded.
- Switched-on Search Function and operation in High Flow: Alarm, when Trigger 2 is exceeded.

0	Off
1	On

Control unit	Setting > Trigger > Search
LD protocol	Command 380
ASCII protocol	Command *CONFig:SEARCh

In the SL3000XL the following are dependent on the trigger used; the leak rate bar, changing the background lighting, the beeper and changing the sniffer tip lighting.

**Sniffer LEDs: Brightness**

Set the brightness of the LEDs designed to illuminate the spot under examination. This setting refers to the measurement process without LED alarm configuration, see below.

From "0" (off) to "6" (max.)

Control unit	Settings > Set up > Operation modes > Sniff > Sniffer > LED > Sniffer LED brightness
LD protocol	Command 414
ASCII protocol	Command *CONFig:BRIGHtness

**Sniffer LEDs: Alarm configuration**

Behavior of the LEDs on the sniffer, when trigger value 1 is exceeded.

Off	No response
Flashing	The LEDs are flashing
Brighter	The LEDs shine with maximum brightness.

	Control unit	Settings > Set up > Operation modes > Sniff > Sniffer > LED > Sniffer LED alarm config.
	LD protocol	Command 413
	ASCII protocol	Command *CONFig:LIGHTAlarm
<b>Sniffer beep: Alarm configuration</b>	Response by the beep on the sniffer if the trigger value is exceeded.	
	Off	No response
	Trigger	Acoustic signal / vibration alarm
	Control unit	Settings > Set up > Operation modes > Sniff > Sniffer > Beep > Sniffer Beep
	LD protocol	Command 417
	ASCII protocol	Command *CONFig:BEEP
<b>Display of the hydrogen percentage</b>	The sniffing with forming gas involves the use of hydrogen. The hydrogen percentage is taken into consideration with this specification. This will increase the displayed leak rate by the corresponding factor. You can also set the gas percentage for other gases (M3, He).	
	0 ... 100 %	
	Control unit	Settings > Set up > Operation modes > Sniff > Gas percentage > Mass2 > Gas percentage H2
	LD protocol	Command 416
	ASCII protocol	Command *CONFig:PERcent
<b>Auto standby interval</b>	Defines the duration in minutes until standby is activated. If the device operates in high flow, the filters of the sniffer line will foul up more quickly. Auto standby switches to low flow for protection. Moving the sniffer line automatically switches the previously selected flow back on.	
	From "0" (off) to "60" (max.)	
	Control unit	Settings > Set up > Operation modes > Sniff > Auto standby > Interval auto standby
	LD protocol	Command 480
	ASCII protocol	Command *CONFig:STANDBYDel
<b>Pressure value XL capillary clogged (high flow)</b>	You set a minimum pressure value in order to detect if the XL capillary (high flow, 3000 sccm) is blocked. If the value is fallen short of, the system issues warning 550. Error message 551 is output with strong lower deviation.	
	100 ... 300 mbar	

	Control unit	Settings > Set up > Operation modes > Sniff > Capillary > Blocked XL > Pressure capillary blocked XL
	LD protocol	Command 455
	ASCII protocol	Command *CONFig:PRESSXLLow
<b>Pressure value XL capillary broken (high flow)</b>	You set a maximum pressure value in order to detect a disruption in the XL capillary (high flow, 3000 sccm). If the value is exceeded, the system issues warning 552.	
	200 ... 600 mbar	
	Control unit	Settings > Set up > Operation modes > Sniff > Capillary > Broken XL > Pressure capillary broken XL
	LD protocol	Command 456
	ASCII protocol	Command *CONFig:PRESSXLHigh
<b>Select flow</b>	Select low flow or high flow. Comment: The selection can also be made with the right sniffer key or assigned to one of the favorite keys of the control unit.	
	Small (low flow) Large (high flow)	
	Control unit	Settings > Configuration > Operating Mode > Flow > Flow Control or Functions > Flow > Flow Control
	LD protocol	Command 229
	ASCII protocol	Command *CONFig:Highflow

## 6.2.7 Operator types and authorizations

There are four different operator types that are distinguished by different authorizations. The integrator is registered ex works.

Additional operators can be registered. The following table shows options for individual operator types to register new operator types.

### Operator registration

Viewer	Operator	Supervisor	Integrator
-	Operator	Supervisor	Integrator
	Viewer	Operator	Supervisor
		Viewer	Operator
			Viewer

For the types "Integrator", "Supervisor" and "Operator", a four-digit PIN must be assigned during registration (0000 ... 9999). "0000" is assigned to all operators ex works.

If an operator keeps the pin "0000", this operator will always be registered is during the start up of the system (without PIN query).

A key-operated switch can be used in addition to a PIN if an I/O module is connected. The key-operated switch is connected to the I/O module via three digital inputs (see operating instructions of the LDS3000).

The following table shows the authorizations of individual operator types.

Function	Viewer	Operator	Supervisor	Integrator
Changing parameters	-	x	x	x
Changing the display of error information	-	x	x	x
Calling up factory settings	-	-	-	x
Entering maintenance history	-	-	-	x

The menu "Service" is accessible only to INFICON service staff.

**Display error information**

The type of error information can be set differently for each operator type. The Integrator always receives the complete information.

Number: Message number  
 text: Brief description  
 Info: Expanded message information

- Only numbers
- Number and text
- Number, text and info

Control unit

Main Menu > Functions > Data > Parameter > Error info Viewer (Operator, Supervisor)

**6.2.7.1 Logging out the operator**

The operator activates access level "Viewer" to log out. "Access Ctrl > Viewer"



## 6.2.8 Setting the audio alarm

### WARNING

#### Damage to hearing due to loud audio

The alarm level of the device can exceed 85 dB(A).

- ▶ Set the volume up to a maximum of "12" (XL3000flex).
- ▶ Use suitable hearing protection at volume settings above "12".
- ▶ With the XL3000flexRC, the actual volume depends on what you plug into the CU1000's headphone jack.

#### Volume of the headphones or active speaker

--- No sound

Proportional: The frequency of the audible signal is proportional to the bar graph display or diagram height. The frequency range is 300Hz to 3300Hz.

Setpoint: The pitch is proportional to the leak rate. The signal sounds if the leak rate exceeds the selected trigger value.

Pinpoint: The sound of the acoustic signal changes its frequency within a specific range of leak rates. Range: A decade below the selected trigger threshold up to one decade above. The sound keeps at a constant low and a constant high frequency below and above this range, respectively.

Trigger: If the selected trigger threshold is exceeded, a two-pitch signal sounds.

Control unit	Main menu > Settings > Set up > Control unit > Audio > Audio alarm mode
--------------	---

**Behavior with warnings or error messages:** If the touch screen shows a warning or an error, then a two-pitch signal sounds simultaneously.

## 6.2.9 Cathode Selection

### Selecting a cathode

The mass spectrometer includes two cathodes. In the factory setting the device uses cathode 1. If it is defective, the device automatically switches to the other cathode. With this setting it is possible to select a certain cathode.

0	CAT1
1	CAT2
2	Auto Cat1 (automatic switching to cathode 2, factory setting)
3	Auto Cat2 (automatic switching to cathode 1)
4	OFF

Control unit	Main menu > Settings > Set up > MS module > Ion source > Cathode selection
LD protocol	530
ASCII protocol	*CONFIg:CAThode *STATus:CAThode

## 6.2.10 Changing the display of the axes

The touchscreen grays out the parameters if

- the user is not authorized to modify the values,
- the older version of the software run by mass spectrometer module LDS3000 does not support this parameter.

### Scaling of the Q(t)axis

Linear or logarithmic	
Lin.	
Log.	
Control unit	Main menu > Display > Q(t) axis > Linear or logarithmic
Number of decades with logarithmic view	
1	
2	
3	
4	
Control unit	Main menu > Display > Q(t) axis > Decades
Autoscale	
Off	
On	
Control unit	Main menu > Display > Q(t) axis > Automatic scaling

### Scaling of the time axis

Scaling of the time axis	
15 s	240 s
30 s	480 s
60 s	960 s
120 s	
Control unit	Display > Time axis > Time axis scale

## 6.2.11 Changing the display of measured values

### Measured value display

Type of graphic display	
Line graph	
Bar graph	
Control unit	Main menu > Display > Measurement display > Measured view
Numeric representation of the measurements	
Off	
On	
Control unit	Main menu > Display > Measurement display > Measured view

## 6.2.12 Displaying Calibration Instructions

Suppress or allow the calibration note with the following content:	
<ul style="list-style-type: none"> <li>• Leak rate of the applied calibration leak</li> <li>• No calibration should take place during the first 20 mins</li> </ul>	
OFF (suppressed)	
ON (allowed)	
Control unit	Main menu > Settings > Set up > Control unit > Messages > Displaying Calibration Instructions

## 6.2.13 Show calibration request

The calibration request can be allowed or suppressed.	
OFF (suppressed)	
ON (allowed)	
Control unit	Settings > Set up > Control unit > Messages > Show calibration request

## 6.2.14 Show warnings

Warnings and error messages can be displayed on the touch screen.	
---	--

Off	
On	
Control unit	Main menu > Settings > Set up > Control unit > Messages > Show warnings

### 6.2.15 Automatic switch-off of the touchscreen

The touch screen can be switched off automatically after a specific time without any operation to save energy.	
30 s	10 min
1 min	30 min
2 min	1 h
5 min	∞ (=never)
Control unit	Main menu > Settings > Set up > Control unit > Energy > Display off after

### 6.2.16 Changing the display brightness

Display brightness	
20 ... 100%	
Control unit	Main menu > Display > Brightness > Display brightness

### 6.2.17 Show setpoint

Selection of the trigger (leak rate threshold) displayed on the touchscreen.	
1	
2	
3	
4	
Control unit	Main menu > Settings > Trigger > Trigger sel.

### 6.2.18 Assigning favorite buttons

The favorite buttons offer direct access to individual functions. They can be assigned with access control "Supervisor" or higher by the user.	
Favorite 1: Center button	

Favorite 2: Right button	
Favorite 3: Button at the bottom right of the main menu	
Volume	Flow switching
Display settings	Check CAL
Start/stop	AQ Assistant (not applicable to XL3000flex!)
Measurement display	Gas equivalent
ZERO	- - - (= nonfunctional)
CAL	
Control unit	Main menu > Settings > Favorites > Favorite 1 (2, 3)

### 6.2.19 Selecting the type of expansion module

**Selecting the expansion module**

Selecting the type of module connected to the I/O connection	
I/O module	
Bus module	
Control unit	Main Menu > Settings > Setup > Interfaces > Device select. > Module on I/O connection or Main Menu > Settings > Setup > Accessories > Device select. > Module on I/O connection
LD protocol	-
ASCII protocol	-

### 6.2.20 General interface settings (I/O module)

**Setting the interface protocol**

Setting the protocol for the module connected to the I/O connection. This setting can be overwritten with the DIP switch on the IO1000.	
LD	
ASCII	
Binary	
LDS1000	
Control unit	Settings > Set up > Interfaces > Protocol > I/O module protocol
LD protocol	2593
ASCII protocol	*CONFig:RS232

## 6.2.21 Assigning analog outputs of the I/O module

The analog outputs of I/O module IO1000 can with assigned with different measurement value displays.

Possible functions: see the following table

Control unit	Main Menu > Settings > Set up > Interfaces > I/O module > Analog outp. > Config. Analog outputs 1/2
LD protocol	Commands 222, 223, 224
ASCII protocol	Command *CONFig:REcorder:LINK1 Command *CONFig:REcorder:LINK2 Command *CONFig:REcorder:SCALE Command *CONFig:REcorder:UPPEREXP

Limit values can be defined for the output voltages.

SNIF:	Min. $1 \times 10^{-9}$ ... $1 \times 10^{-1}$ mbar l/s Max. $1 \times 10^{-8}$ ... $1 \times 10^{-1}$ mbar l/s
-------	--

Control unit	Main Menu > Settings > Set up > Interfaces > LR limits
LD protocol	Command 227 (Snif)
ASCII protocol	Command *CONFig:LIMITS:SNIF

Functions, assignment of analog outputs:

Off	The analog outputs are switched off (Output voltage = 0 V).	
Pressure p1 / Pressure p2	1 ... 10 V; 0.5 V / decade; 1 V = $1 \times 10^{-3}$ mbar	
Leak rate mantissa	1 ... 10 V; linear; in the selected unit	Useful only if the other analog output is assigned "Leak rate exponent".
Leak rate exponent	1 ... 10 V; 0.5 V / decade; Step function; 1 V = $1 \times 10^{-12}$ ; in selected unit	Useful only if the other analog output is assigned "Leak rate mantissa" or "Leak rate ma. Hys." is occupied.
Linear leak rate	x ... 10 V; linear; in the selected unit	

The upper limit (= 10 V) is set via the parameter "Upper limit exponent". The lower value is always 0 (leak rate), which corresponds to 0 V output voltage. The exponent of the upper limit can be set in entire decades, such as  $1 \times 10^{-4}$  mbar l/s.

Settings > Set up > Interfaces > I/O module > Analog scale > AO exponent upper limit.

This setting is for both analog outputs, if an appropriate output function is selected. Depending on the selected leak rate unit there is a different absolute limit.

The selected range can be additionally narrowed by the limits, which is valid for all interfaces, see above.

Leak rate log.	x ... 10 V; logarithmic; in the selected unit
----------------	--

The upper limit (= 10 V) and the scale (V / decades) are set via the parameters "Upper limit exponent" and "Scale for leak rate". For example:

Upper limit set to  $1 \times 10^{-5}$  mbar l/s (= 10 V). Scale set to 5 V / decade. Lower limit is at  $1 \times 10^{-7}$  mbar l/s (= 0 V). The logarithmic output function of both the slope in V / decade as well as the upper limit (10 V limit) can be set. This results in the minimum displayable value. The following slopes are available: 0.5, 1, 2, 2.5, 3, 5, 10 V/Decade. The higher the selected slope value, the smaller the displayable area. The logarithmic settings are the most useful when several decades can be displayed, so a setting of <10 V / decade. The upper limit is the same for both analog outputs. In both of the following figures the 1 V / decade and 5 V / decade with different upper limit settings are exemplified. Depending on the selected leak rate unit there is a different absolute limit. The selected range can be additionally narrowed by the limits, which is valid for all interfaces, see above.

Set by interface	The output voltage can be specified for tests with the LD log command 221.
------------------	--

Leak rate Ma. Hys.	0.7 ... 10 V; linear; in the selected unit	Useful only if the other analog output is assigned "Leak rate exponent". Through an overlap of the mantissa in the range 0.7 to 1.0, a constant jumping between two decades is prevented. 0.7 V corresponds to a leak rate of $0.7 \times 10^{-x}$ . 9.9 V corresponds to a leak rate of $9.9 \times 10^{-x}$ .
--------------------	---	---

Pressure p1 (1 V / Dec.)/ Pressure p2 (1 V / Dec.)	1 ... 10 V; 1 V / decade; 2.5 V = $1 \times 10^{-3}$ mbar; 8.5 V = 1000 mbar
---	--

Leak rate log. H./ Leak rate exp. Inv.	Special function. Use only on the recommendation of INFICON.
---	--

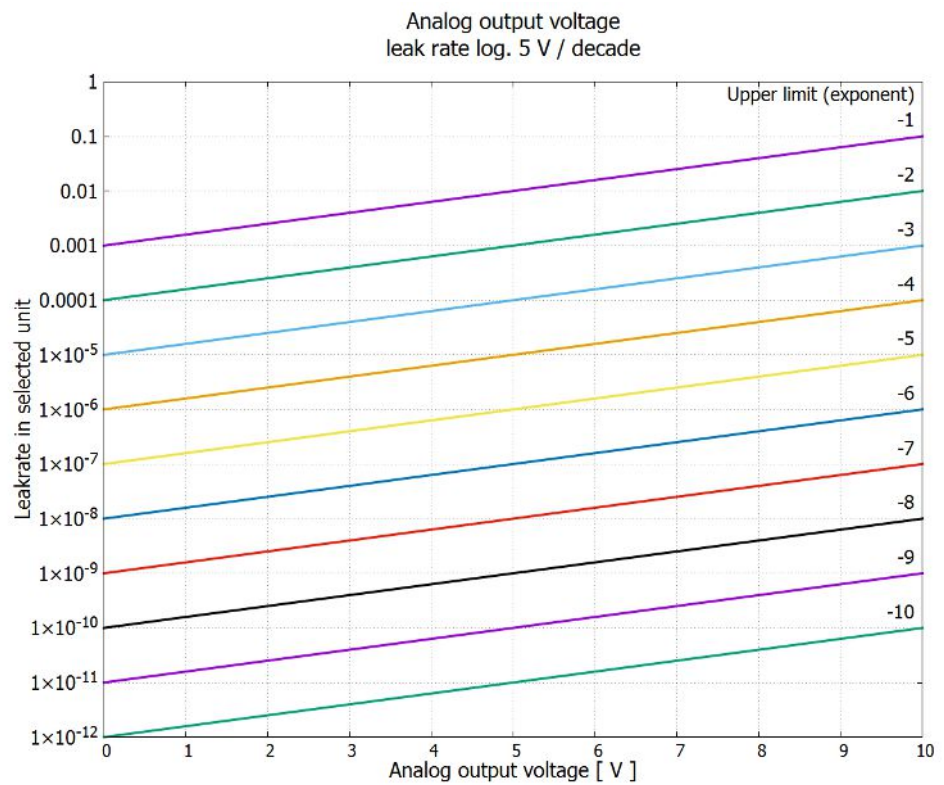
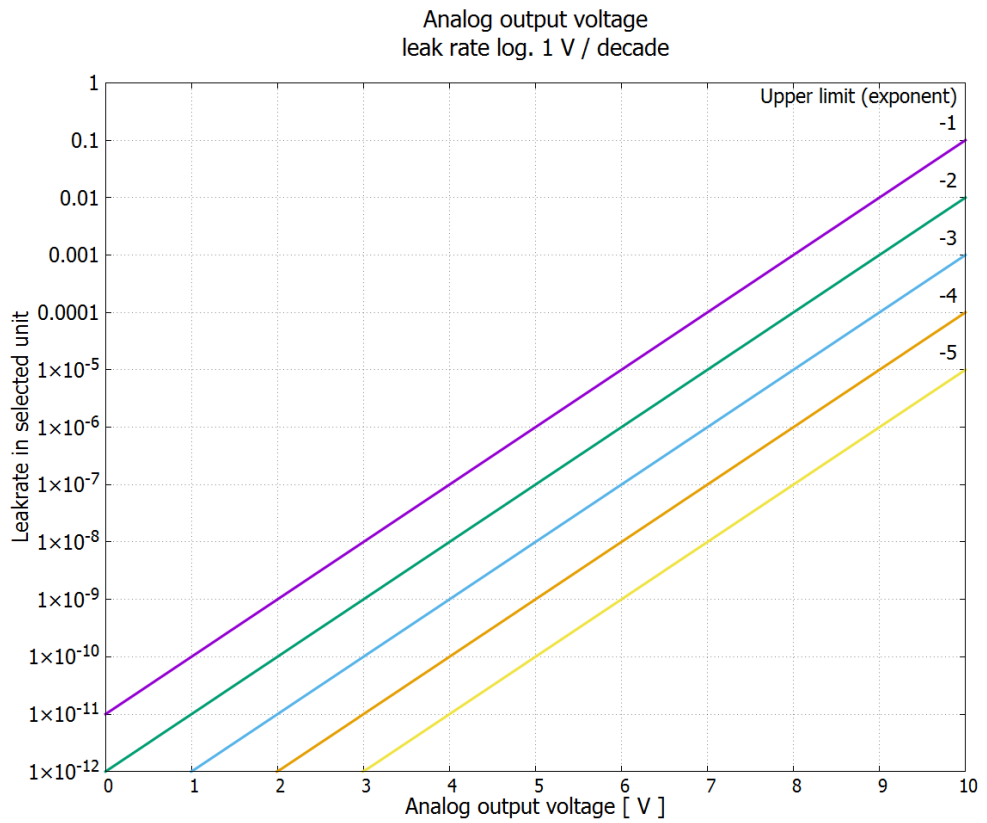



## 6.2.22 Assigning the digital inputs of the I/O module

The digital inputs PLC-IN 1 ... The available functions can be assigned in any way necessary to the 10 I/O module.

- Active signal: typically 24 V
- Inactive signal: typically 0 V.

The 24V output of the I/O module can be used as an active signal.

Every function can be inverted.

Possible functions: see the following table

Control unit	Settings > Set up > Interfaces > I/O module > Digital inputs > Configuration PLC Input
LD protocol	Command 438
ASCII protocol	*CONFig:PLCINLINK:1 (2 ... 10)

### Key-operated switch

An external key switch with up to three switching outputs can be connected via three PLC inputs. The key switch can be used to select the access level of the operator of the control unit.

Button 1 - Operator

Button 2 - Supervisor

Button 3 - Integrator

Example for a suitable key switch: Hopt+Schuler, No. 444-05

Functions, assignment of digital inputs:

Function	Flank/state:	Description
No function	–	No function
CAL dynam.	inactive→ active: active→ inactive:	Start external dynamic calibration. Apply value for background and finish calibration.
CAL external	inactive→ active: active→ inactive:	Start external calibration. Apply value for background and finish calibration.
SNIF/VAC	inactive→ active:	Enable sniffer mode.
Start	inactive→ active:	Switch to Meas. (ZERO is possible, all trigger outputs switch depending on the leak rate.)
STOP	inactive→ active:	Switch to Standby. (ZERO is not possible, all trigger outputs will return "Leak rate threshold value exceeded".)

Function	Flank/state:	Description
ZERO	inactive→ active: active→ inactive:	Switch ZERO on. Switch ZERO off.
ZERO pulse	inactive→ active:	Switching ZERO on or off.
Delete	inactive→ active:	Erase warning or error message / cancel calibration.
Gas ballast	inactive→ active: active→ inactive:	Open gas ballast valve. In the XL3000flex without function. Close gas ballast valve unless always open.
Selection dyn/ norm	inactive→ active:  active→ inactive:	External calibration mode with activation of digital input "CAL":  External dynamic calibration (without auto tune, allowing for the measuring times and pump cycle times set via the digital inputs) External normal calibration (with auto tune, not considering the system-specific measuring times and pump cycle times)
Start / Stop	inactive→ active:  active→ inactive:	Switch to Meas. (ZERO is possible, all trigger outputs switch depending on the leak rate.)  Switch to Standby. (ZERO is not possible, all trigger outputs will return "Fail".)
Key 1	active:	User "Operator"
Key 2	active:	User "Supervisor"
Key 3	active:	User "Integrator"
CAL	inactive→ active:	When set to Meas, the device will start an external calibration.
ZERO update	inactive→ active:	A new zero word is formed.
XL flow	inactive→ active: active→ inactive:	The XL flow is turned on with the XL Adapter. The XL flow is turned off with the XL Adapter.
CAL Mach	inactive→ active:	Start machine factor calibration

Function	Flank/state:	Description
Internal PROOF	inactive→ active:	Start the internal Proof function. In the XL3000flex without function.
External PROOF	inactive→ active:	Start the external Proof function.
START / STOP impulse	inactive→ active:	Activate Start or Stop.
ZERO update	inactive→ active: active→ inactive:	Update or switch on ZERO  No function
Flow	inactive→ active: active→ inactive:	Switch flow of SL3000XL to 3000 sccm (XL adapter)  Switch flow of SL3000XL to 300 sccm (XL adapter)
CAL machine	inactive→ active:	Determining the machine factor or of the sniff factor
External CAL check	inactive→ active:	Check calibration with external calibration leak
Start / Stop impulse	inactive→ active:	Switching between measuring operation and standby
Mass 2 / Mass 4	inactive→ active: active→ inactive:	Activate mass 4  Activate mass 2
Photo interrupter	inactive→ active: active→ inactive:	Sniffer tip at calibration leak, calibration starts.  Sniffer tip has been removed.

### 6.2.23 Assigning the digital outputs of the I/O module

The digital outputs PLC-OUT 1 ... The available functions can be assigned in any way necessary to the 8 I/O module.

Every function can be inverted.

Possible functions: see the following table

Control unit	Settings > Set up > Interfaces > I/O module > Digital outputs > Configuration PLC Output
--------------	--

LD protocol	Command 263
ASCII protocol	*CONFig:PLCOUTLINK:1 (2 ... 8)

Functions, assignment of digital outputs:

Function	State:	Description
Open	open:	always open
Trigger 1	closed:	Value exceeded leak rate threshold Trigger 1
	open:	Value fell below leak rate threshold Trigger 1
Trigger 2	closed:	Value exceeded leak rate threshold Trigger 2
	open:	Value fell below leak rate threshold Trigger 2
Trigger 3	closed:	Value exceeded leak rate threshold Trigger 3
	open:	Value fell below leak rate threshold Trigger 3
Trigger 4	closed:	Value exceeded leak rate threshold Trigger 4
	open:	Value fell below leak rate threshold Trigger 4
Ready	closed:	Emission switched on, calibration process inactive, no error
	open:	Emission switched off or calibration process active or error
Warning	closed:	Warning
	open:	no warning
Error	closed:	Error
	open:	no error
CAL active	closed:	Device is to be calibrated.
	open:	Device is not to be calibrated.
CAL request	closed:	and no external calibration: Calibration request (with temperature change from 5°C or 30 minutes after the start-up or if default rotation speed was changed)
	closed:	and external calibration or "CAL check": Request "Open or close external calibration leak"
	open:	no request
Run-up	closed:	Run-up
	open:	no run-up
ZERO active	closed:	ZERO switched on
	open:	ZERO switched off
Emission on	closed:	Emission switched on
	open:	Emission switched off

Function	State:	Description
Measure	closed:	Measuring (ZERO is possible, all trigger outputs switch depending on the leak rate.)
	open:	Standby or emission disabled (ZERO is not possible, all trigger outputs will return "Leak rate threshold value exceeded".)
Standby	closed:	Standby (ZERO is not possible, all trigger outputs will return "Leak rate threshold value exceeded".)
	open:	Measuring (ZERO is possible, all trigger outputs switch depending on the leak rate.)
SNIF	closed:	SNIF
	open:	VAC
Error or warning	closed:	Error or warning
	open:	No error or warning
Gas ballast	closed:	Gas ballast is active
	open:	Gas ballast is inactive
Calibration leak open	closed:	calibration leak is active
	open:	calibration leak is inactive
CAL stable	closed:	Calibration completed with calibration leak (see "Time and general preferences [▶ 60]")
	open:	Assignment not stable or calibration is inactive
Cathode 2	closed:	Cathode 2 is active
	open:	Cathode 1 is active

## 6.2.24 Settings for bus module BM1000

### Address of bus module

Setting the bus module address. (Node address with Profibus, MACID with DeviceNet)

0 ... 255

Control unit	Settings > Set up > Interfaces > Bus module > Address
--------------	---

LD protocol	326
-------------	-----

ASCII protocol	–
----------------	---

## 6.2.25 Operation mode "Sniffing"

The device has the sniffer mode with a high flow rate.

For the XL3000flex , only this operation mode makes sense.

Select operation mode	
0	(Not applicable for XL3000flex!)
1	(Not applicable for XL3000flex!)
2	Operation mode XL sniffer adapter
Control unit	Sniffer mode: Main Menu > Functions > Start/Stop
LD protocol	Command 401
ASCII protocol	Command *CONFig:MODE

## 6.3 Settings for the measurements

### 6.3.1 Select gas type (mass)

The machine, calibration and sniff factor are dependent on the configured mass and are saved in the mass spectrometer module.

2	H <sub>2</sub> (Hydrogen, forming gas)
3	<sup>3</sup> He or deuterated hydrogen (HD)
4	<sup>4</sup> He (Helium) (factory setting)

Control unit	Main menu > Settings > Mass
LD protocol	Command 506 with value 2 (3, 4)
ASCII protocol	Command *CONFig:MASS 2 (3, 4)

### 6.3.2 Display equivalence leak rate for other gas

If you measure with the test gases helium or hydrogen, but want to display another gas with its leak rate, use a correction factor for the test gas used.

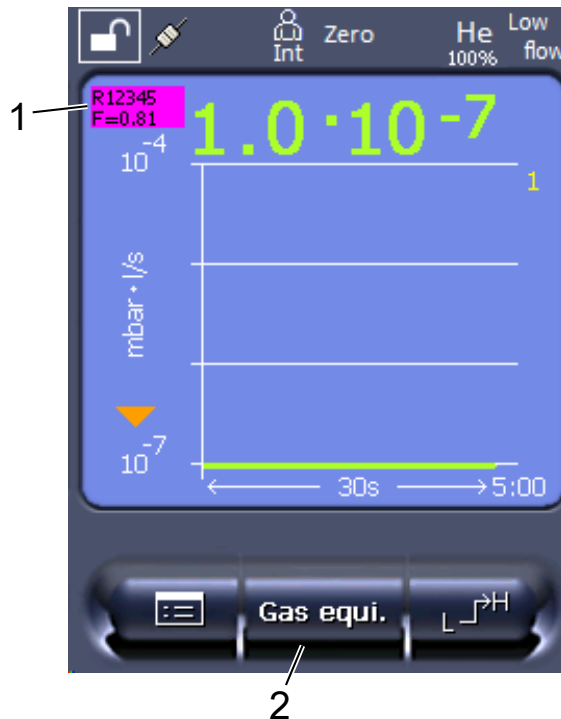

Fig. 3: Measurement screen with displayed equivalence leak rate and configured favorites key

- |   |  |
|---|--|
| 1 | Display of gas name and equivalence factor   |
| 2 | Favorites key for fast configuration of "gas equivalent selection" after set up, see "Assigning favorite buttons [▶ 44]" |

You have a choice of two methods:

- To conveniently set the correction factor, use the "Gas equivalent selection [▶ 56]". There, the correction factor can be selected from a self-defined list, see "Configure gas list [▶ 56]", or switched back to the tracer gas.
- Alternatively, it is possible to calculate and configure the correction factor. For information on calculation, see "Calculate equivalence factor [▶ 57]". For information on configuring the device, see "Set equivalence factor and molar mass [▶ 58]".

### 6.3.2.1 Gas equivalent selection

- 1 Control unit: Settings > Set up > Operation modes > Equivalence leak rate > Gas equi."
- 2 In the window "Gas equivalent selection", you can respond to different situations:
  - ⇒ If the desired gas equivalent is already stored (numbers 1 to 4), select the desired gas equivalent number and confirm with "OK". The gas name and the equivalence factor of this gas equivalent are then displayed at the top left in the measuring window. You can perform measurement.
  - ⇒ If the desired gas equivalent is not stored, it must be configured, see "Configure gas list [▶ 56]".
  - ⇒ If you do not find a suitable entry in the 4 gas equivalents and also do not want to change these, you can calculate the correction factor as an alternative. In the window "Gas equivalent selection" select the entry "User-defined" and configure the correction factor, see "Set equivalence factor and molar mass [▶ 58]".
  - ⇒ If you want to switch from the display of the gas equivalent in the measuring window back to the measurement value of the measuring gas, select "Switch off" and confirm with "OK".



The options "Switch off" and "Gas equivalent no. 1...4" overwrite parameters, see "Set equivalence factor and molar mass [▶ 58]".

If you select the option "User-defined", parameters then have to be configured, see "Set equivalence factor and molar mass [▶ 58]".

---

### 6.3.2.2 Configure gas list

You can predefine up to 4 equivalence gases and assign names to them. The equivalence gases can then be selected in the gas equivalent selection, see "Gas equivalent selection [▶ 56]".

- 1 Control unit: Settings > Set up > Operation modes > Equivalence leak rate > Configure gas list



- 2 Select one of the numbers 1 to 4.
  - ⇒ A set of parameters is displayed for each stored gas. If there is an unused entry, "No Entry" is displayed.
- 3 Press the button "Edit".
  - ⇒ If you want to detect one of the gases from the stored gas library, press the desired entry. See also "Gas library [▶ 93]".
  - ⇒ If the desired gas is not stored, scroll to the end of the gas library and select "User-defined gas". Then, assign a name of your choice in the window "Equivalence gas name" and confirm your choice. Then enter the molar mass and viscosity factor of the equivalence gas. For all gases that are not available in the gas library, please feel free to contact INFICON.
- 4 Make your customer-specific entries in the following windows, which are brought up by the assistant, first "Absolute pressure equivalence gas".
  - ⇒ Corresponds to the absolute pressure of the equivalence gas in the test object in bar.
- 5 Window "Measuring mass".
  - ⇒ This is the mass of the tracer gas (helium, mass 3 or hydrogen)
- 6 Window "Percentage of measuring gas".
  - ⇒ This is the gas proportion of the tracer gas in percent, e.g. for forming gas (95/5) it would be 5%.
- 7 Window "Absolute pressure measuring gas".
  - ⇒ Corresponds to the absolute pressure of the tracer gas in the test object in bar.

### Example

An air conditioning system is to be checked for leaks. The system is first filled with 2 bar (absolute) pure helium and checked for leaks. Later the plant will be filled with R134a. The operating pressure is 15 bar (absolute).

This results in the following values for the above-specified parameters:

Absolute pressure equivalence gas = 15.0

Measuring mass = 4

Percentage of measuring gas = 100.0

Absolute pressure measuring gas = 2.0

#### 6.3.2.3 Calculate equivalence factor

The equivalence factor is not calculated by the software of the device. Calculate the equivalence factor using the following formula:

$$\text{Equivalence factor} = \frac{\eta_{test}}{\eta_{equi}} * \frac{(p_{equi})^2 - 1}{(p_{test})^2 - 1}$$

$\eta_{\text{Test}}$	Dynamic viscosity of test gas (helium or H <sub>2</sub> )
$\eta_{\text{equi}}$	Dynamic viscosity of the equivalent gas
$p_{\text{test}}$	Absolute pressure of the test gas in the test object in bar
$p_{\text{equi}}$	Absolute pressure of the equivalent gas in the test object in bar

**For example**

An air conditioning system is to be checked for leaks.

The system is first filled with 2 bar (absolute) helium and checked for leaks. Later the plant will be filled with R134a. The operating pressure is 15 bar (absolute).

The dynamic viscosity of helium is 19.62  $\mu\text{Pa}\cdot\text{s}$ .

The dynamic viscosity of R134a is 11.49  $\mu\text{Pa}\cdot\text{s}$ .

In order to obtain an R134a equivalent leak rate display during the helium leak detection, the following equivalence factor must be entered:

$$\text{Equivalence factor} = \frac{\eta_{\text{test}}}{\eta_{\text{equi}}} * \frac{(p_{\text{equi}})^2 - 1}{(p_{\text{test}})^2 - 1} = \frac{19,62}{11,49} * \frac{15^2 - 1}{2^2 - 1} \approx 127$$

### 6.3.2.4 Set equivalence factor and molar mass

- ✓ The equivalence factor is known. See also "Calculate equivalence factor [► 57]".
- ✓ The test gas used is specified (hydrogen or helium, mass 2, 3 or 4).
- ✓ The molar mass of the equivalence gas you want to display is known.
  - 1 Control unit: Settings > Set up > Operation modes > Equivalence rate
  - 2 "Gas factor" button
    - ⇒ (LD protocol: Command 469)
  - 3 Select "Mass 2", "Mass 3" or "Mass 4" according to your test gas.
    - ⇒ If the test gas is set to helium, the window "Equivalent Gas Factor He" opens.
  - 4 Set the equivalence gas factor. In the example (see "Calculate equivalence factor [► 57]") for 127:

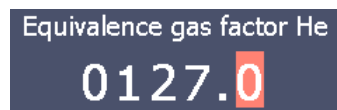

- 5 Control unit: Settings > Set up > Operation modes > Equivalence rate
- 6 "Molar mass" button
  - ⇒ (LD protocol: Command "470")
- 7 Select "Mass 2", "Mass 3" or "Mass 4" to match your test gas as described above.
  - ⇒ If the test gas is set to helium, the window "Molar mass equivalent gas He" opens.

8 Set your molar mass. In the example for 102:

Molar mass equivalence gas He  
**0102.0**

- ⇒ If the equivalence factor is not equal to 1 or the molar mass is not set to factory settings, the equivalence factor is displayed both on the calibration result and on the measurement screen.



Fig. 4: Top left: Display of Molar Mass (102) and Equivalence Factor (127)

### 6.3.3 Setting setpoints

You can set the leak rate for the setpoint to 1, 2, 3 and 4 separately.

When the setpoints are exceeded:

- If the setpoint 1 or 2 is exceeded, the measurement line in the measurement window changes color.
- The setpoint relay of the digital output switches, see also "Assigning the digital outputs of the I/O module [▶ 51]" or the interface description.

Also setpoint 1 defines the trigger point for the different alarms, see also "Setting the audio alarm [▶ 41]".

✓   **Operator or Supervisor rights**

1  > Trigger

2 Adjust.

3 Save .

## 6.3.4 Calibrating the device

### 6.3.4.1 Time and general preferences

#### NOTICE

##### Incorrect calibration because of operating temperature that is too low

If the instrument is calibrated immediately after power-on, it may provide incorrect measurement results.

- For optimum accuracy the device should have been turned on at least 20 minutes previously.

The device only needs to be calibrated once per shift for the desired gas. Thereafter you can switch between the different flows without re-calibrating.

Calibration is also required after the following actions:

- Sniffer line replacement
- Filter change of the sniffer line
- Prompt for calibration by the system

#### Switching off the preamplifier test

The device tests the installed preamplifier during calibration. You can switch off of the amplifier test. This increases the speed of the calibration, but reliability drops off.

0	OFF
1	ON

Control unit	Main Menu > Settings > Set-up > MS-module > Preamplifier > Test > Preamplifier test with CAL
--------------	--

LD protocol	Command 370
-------------	-------------

ASCII protocol	Command *CONFig:AMPTest (ON,OFF)
----------------	----------------------------------

#### Enabling calibration request

If Calibration request is enabled, the device will prompt the operator to perform a calibration 30 minutes after it has been switched on and in case of temperature changes greater than 5°C.

0	OFF
1	ON

Control unit	Main Menu > Functions > CAL > Settings > CAL request. > Calibration request or Main Menu > Settings > Set-up> CAL request. > Calibration request
LD protocol	Command 419
ASCII protocol	*CONFig:CALREQ (ON,OFF)

### Calibration warning Wrn650

The warning message Wrn650 "Calibration within the first 20 minutes is not recommended" can be allowed or suppressed.	
0	OFF (suppressed)
1	ON (allowed)
Control unit	Functions > CAL > Settings > CAL request. > Calibration warning W650 or Settings > Set-up> CAL request. > Calibration warning W650
LD protocol	Command 429
ASCII protocol	*CONFig:CALWarn ON (OFF)

### 6.3.4.2 External Calibration Configuration and Start

Prerequisite for the calibration with the internal calibration leak is the one-time entry of the leak rate of the calibration leak.

In Sniffer mode, sniffing with the sniffer line is always performed on the open calibration leak.

### Leak rate of external calibration leak sniffing

Define the leak rate of the calibration leak you wish to use during calibration. Calibration will not be possible unless you enter the value here. A specific leak rate must be set for each gas (mass).	
Control unit	Main Menu > Settings > Set up > Operation modes > Sniffing > Ext. calibration leak > Mass 2 (3, 4) or Main menu > Functions > CAL > Settings > Ext. calibration leak (for current mass in selected unit)
LD protocol	Command 392

ASCII protocol	Command *CONFig:CALLeak:EXTSniff (for current mass in device selected unit)
----------------	---

► LD and ASCII protocol: The status must be queried via: Command 260 or \*STATus:CAL

- 1** Start calibration.
- 2** Wait until leak rate signal is tuned and stable.
- 3** Start calibration:  
Control unit: Features > CAL > Extern  
LD protocol: 4, Parameter 1  
ASCII protocol: \*CAL:EXT  
IO1000: see the figure below.  
⇒ Request to "close calibration leak"
- 4** Sniffer mode: Remove sniffer line from calibration leak.  
⇒ Leak rate signal decreases.
- 5** Confirm measured background value is stable:  
Control unit: "OK"  
LD protocol: 11, Parameter 1  
ASCII protocol: \*CAL:CLOSED  
IO1000 see the figure below.  
⇒ Calibration is completed if:  
Control unit: Old and new calibration factor are displayed  
LD protocol LD instruction 260 provides 0 (READY)  
ASCII protocol: Command \*STATus:CAL? provides IDLE  
IO1000 see the figure below.

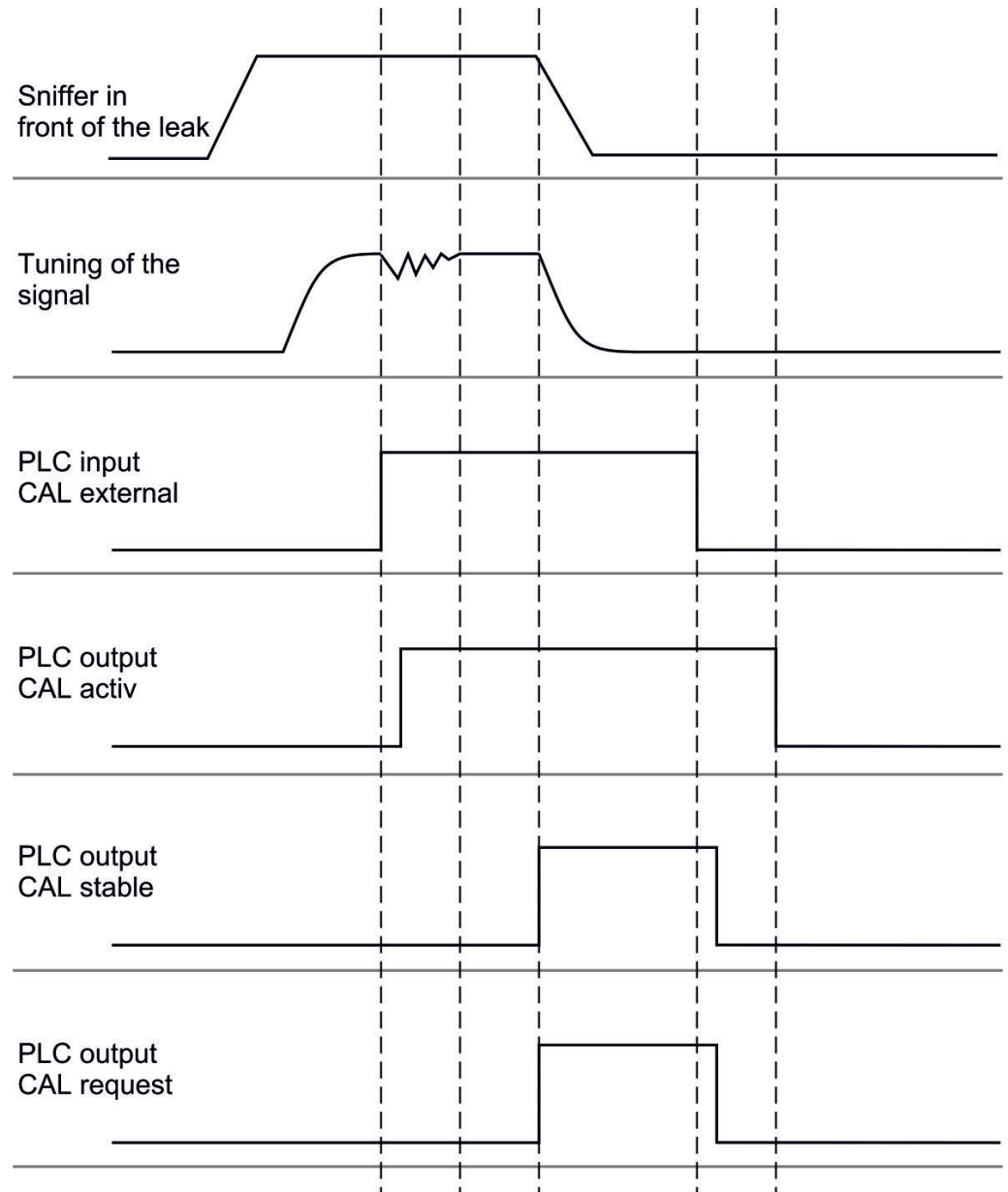

Fig. 5: External calibration with IO1000 using the example of sniffer line SL3000XL, description of PLC inputs and outputs: "Assigning analog outputs of the I/O module [► 46]"

#### 6.3.4.3 Check the calibration

To check whether a re-calibration is necessary, check the already existing.

#### 6.3.4.4 Calibration using the external calibration leak test

► LD and ASCII protocol: The status must be queried via: Command 260 or \*STATus:CAL

- 1 Hold the sniffer line to the test leak.
- 2 Wait until leak rate signal is tuned and stable.

- 3** Start test:  
Control unit: Functions > CAL > Test ext.  
LD protocol: 4, Parameter 5  
ASCII protocol: \*CAL:PROOFEXT  
IO1000 compare figure in "External Calibration Configuration and Start".  
⇒ Request to "close calibration leak"
- 4** Sniffer mode: Remove sniffer line from calibration leak.  
⇒ Leak rate signal decreases.
- 5** Confirm measured background value is stable:  
Control unit: "OK"  
LD protocol: 11, Parameter 1  
ASCII protocol: \*CAL:CLOSED  
IO1000 compare figure in "External Calibration Configuration and Start".  
⇒ Test is completed if:  
Control unit: Result is displayed  
LD protocol: As with the other steps, the status must be queried  
ASCII protocol: As with the other steps, the status must be queried  
IO1000 compare figure in "External Calibration Configuration and Start".

#### 6.3.4.5 External calibration with sniffer line SL3000XL

Low flow and high flow must be calibrated separately.

For calibration we recommend our test leak with catalogue number 12322 for forming gas applications or 12237 for helium applications.

To ensure optimum calibration, the calibration leak must meet the following requirements:

##### For calibration at Low-flow:

- Helium: Leak rate >  $1 \times 10^{-5}$  mbar l/s
- 100 % H<sub>2</sub>: Leak rate >  $1 \times 10^{-4}$  mbar l/s
- Forming gas (95/5): Leak rate >  $2 \times 10^{-3}$  mbar l/s

##### For calibration at High-flow:

- Helium: Leak rate >  $1 \times 10^{-4}$  mbar l/s
- 100 % H<sub>2</sub>: Leak rate >  $1 \times 10^{-3}$  mbar l/s
- Forming gas (95/5): Leak rate >  $2 \times 10^{-2}$  mbar l/s



### 6.3.4.6 Automate external calibration with CalMate (optional)

#### **⚠ WARNING**

##### **Danger to pacemaker wearers from magnets**

The calibration adapter contains magnets with which it adheres to the calibration leak.

- ▶ If you wear a pacemaker, do not install it yourself.
- ▶ If you wear a pacemaker, always maintain a distance of at least 10 cm from the calibration adapter when operating the device.

In sniffer mode, it is possible to automate calibrations with an external calibration leak.



- ✓ The CalMate calibration adapter is mounted on an external INFICON sniffer calibration leak so that the opening in the adapter is directly above the outlet of the calibration leak.
- ✓ The calibration adapter is connected to the leak detector by cable. For further details, refer to the "CalMate Calibration Adapter for Test Leaks" operating instructions.
- ✓ If there is no separate interface on the back of the XL3000flex for connecting the connection cable, you have established the connection via the IO1000 module. See also "Device setup [▶ 14]".
- ✓ Using the CalMate on the XL3000flex requires a basic unit software version of V2.74 or higher.
- ✓ In the sniffer leak detector, the gas type (mass) and leak rate of the external calibration leak are set.
  - 1 Start the calibration check in the XL3000flex by inserting the sniffer tip into the calibration port on the CalMate.
    - ⇒ A light barrier in the CalMate adapter detects when a sniffer tip is held in the calibration opening.
    - ⇒ If a significant error is detected during this check, the leak detector recommends another calibration.

- 2 If you want to perform a calibration, insert the sniffer tip into the calibration opening again and then immediately press the right button on the sniffer line.  
⇒ Otherwise the calibration would only be checked again.



### Change settings

The aforementioned behavior can be changed by configuring the "CalMate mode" in the menu "Main menu > Settings > Set up > Accessories > CalMate". You have a choice of 3 options there:

**0 = PROOF / CAL**

Inserting the sniffer tip into the calibration opening starts the calibration check. Pressing the right-hand button of the sniffer line switches to calibration (factory setting).

**1 = CAL only**

Inserting the sniffer tip into the calibration opening starts the calibration. It is not possible to check the calibration.

**2 = PROOF only**

Inserting the sniffer tip into the calibration opening starts the calibration check. It is not possible to switch to calibration.

### 6.3.4.7 Entering the calibration factor

The calibration is usually determined by the appropriate calibration routine. Therefore, it is usually not necessary to adjust the calibration factor manually.

An incorrectly set calibration inevitably leads to wrong leak rate indicator!

### 6.3.4.8 Calibration factor sniffing

	<p>Entry of the calibration factors for masses 2, 3, 4 in low flow and in high flow.</p> <p>The values will be overwritten during the next calibration.</p> <p>"High Flow-" or XL settings are available only in operation mode "XL Sniffer Adapter".</p>	
	<p>The calibration factors are managed separately to earth and to "High Flow" and "Low Flow".</p> <p>0.01 ... 100</p>	
Control unit	Main Menu > Settings > Set up > Operation modes > SNIF > Calibration factor	

	Mass	Calibration factor SNIF
	2	H2
	3	M3
	4	He
	2XL	XL H2
	3XL	XL M3
	4XL	XL He
LD protocol	Commands 519, 521	
ASCII protocol	Command *FACtor:CALSniff or *FACtor:CALXML for the current mass	

### 6.3.5 Suppressing gas backgrounds with "ZERO" functions

Unwanted sample gases can be suppressed with ZERO. If ZERO is enabled, the currently measured leak rate value will be interpreted as carrier gas and subtracted from all subsequently measured values. The background value suppressed by ZERO is adjusted automatically if the background changes inside the device. The background value is automatically adjusted depending on the set ZERO time, except for filter setting I•CAL, see "Measurement result display with signal filters [▶ 69]".

#### Activating and deactivating ZERO

ZERO activate/deactivate	
0	On
1	Off
Control unit Main menu > Function > ZERO > ZERO	
LD protocol	Command 6
ASCII protocol	Command ZERO

#### Setting ZERO mode

Specified the level of the helium background suppressed by ZERO (not with filter I•CAL).	
0	all decades
1	1 – 2 decades
2	2 – 3 decades
3	2 decades
4	3 – 4 decades
5	19/20 of the tracer gas are suppressed
Control unit Main Menu > Settings > ZERO/filter > ZERO > ZERO mode	
LD protocol	Command 410
ASCII protocol	Command *CONFIg:DECADEZero

**Deactivating the ZERO key on the sniffer**

Deactivation of the ZERO-key (ZERO-alignment) prevents that the measurement is influenced inadvertently.

0	On
---	----

1	Off
---	-----

Control unit	Main Menu > Settings > Setup > Modes > Sniff > Sniffer > Button > ZERO at startup
--------------	---

LD protocol	Command 412
-------------	-------------

ASCII protocol	Command *CONFig:BUtSniffer
----------------	----------------------------

## 6.4 Measuring

- ✓ The sniffer line SL3000XL is optionally connected to the rear side of the device, see Device setup [▶ 14]".
- ✓ Possible alternatives to the operating possibilities on the device are set up (optional):  
I/O-Modul or Bus-Modul, see "Accessories [▶ 101]".
  - 1 Switch on the leak detector via the power supply switch.
    - ⇒ After start-up, the device is ready for operation; no special start procedure for measuring is required.
  - 2 Make sure that the correct basic settings and the settings for the current measurement are carried out, see "Basic settings [▶ 34]" and "Settings for the measurements [▶ 55]".
  - 3 Make sure that calibration takes place daily.
    - ⇒ When performing a calibration, note the 20 minute warm-up time, see "Calibrating the device [▶ 60]".
  - 4 To measure, hold the sniffer tip close to the possible leak or run it along a weld, for example.
    - ⇒ The tip must touch the test object.
    - ⇒ If the detection limit has deteriorated, you can detect leaks at a greater distance (high flow) from the suspected leak and switch to low flow using the right button of the sniffer handle for more accurate location.
  - 5 Track the measurement result either as a line or as a bar graph, see "Touchscreen elements [▶ 20]".
  - 6 To measure small leak rates more clearly, use the ZERO function. To switch on, press the ZERO button on the sniffer handle for a longer period (> 5 s), see also Operating elements on the handle [▶ 19]".
    - ⇒ To activate ZERO on the sniffer probe, it must be activated in the menu, see also Suppressing gas backgrounds with "ZERO" functions [▶ 67]".
    - ⇒ If ZERO is switched on, you will see the text ZERO with white background in the measurement window.
  - 7 Record the measured values if necessary, see "Recording data [▶ 71]" and "Copying measurement data, deleting measurement data [▶ 72]".
  - 8 Switch the instrument off.

## 6.5 Measurement result display with signal filters

### Select signal filter

With the signal filters, the leak rate indicator regarding slope and noise behavior can be influenced.

<ul style="list-style-type: none"> <li>– Generally select signal filter I-Filter for the operation mode "Sniff".</li> <li>– If the signal filter should simulate the time behavior of older units, then select filter "Fixed" or "2-Zone".</li> </ul>	
I•CAL	The leak rates are averaged at time intervals that are optimized for the range of the leak rates. The algorithm used offers excellent sensitivity and response time. Use of this setting is strongly recommended.
fixed	The leak rates are averaged at fixed intervals of 0.2 seconds.
2-zone	The filter is compatible with LDS1000 and LDS2000. The averaging period is switched depending on the filter leak rate threshold.
I-Filter	Filter optimized for sniffer mode. (Default with XL Sniffer Adapter set)
I-Filter slope suppress.	Same as I-Filter, but with additional slope suppression. The edge suppression corrects the measurement changes during the warm-up phase.
Control unit	Main Menu > Settings > ZERO/Filter > Filter > Filter mode
LD protocol	Command 402
ASCII protocol	Command *CONFig:FILTER

### Setting the filter leak rate threshold

Leak rate background in mbar l / s for the averaging period. The averaging period is 10.24 s below this value. Above this value, the averaging period is 160 ms. Setting applies only to filter "2-stage".	
1E-11 ... 9.9E-3	
Control unit	Main Menu > Settings > ZERO/Filter > Settings > Filter 2-zone
LD protocol	Command 403
ASCII protocol	Command *CONFig:LRFilter

### Setting filter ZERO time

Update interval for the offset value with negative leak rate signal (except for I•CAL filter).	
Resolution 0.1 s (50 = 5.0 s)	
Control unit	Main Menu > Settings > ZERO/Filter > Settings filter > ZERO time
LD protocol	Command 411
ASCII protocol	Command *CONFig:ZEROTIME

## 6.6 Recording data

The data is saved as a TXT file. Each TXT file contains the following information:

- Date created
- Software version
- Serial number
- Start time
- Time stamp (measurement indicates offset in seconds in relation to start time)
- File name
- Leak rate (expressed in selected unit)
- Pressure p1 (expressed in selected unit)
- Device status

<b>Switching on/off</b>	Switching data recording on/off	
	<ul style="list-style-type: none"> <li>• Off</li> <li>• On</li> </ul>	
	Control unit	Main Menu > Functions > Data > Recorder > Settings > Data recording
<b>Record interval</b>	Time interval between data recordings	
	<ul style="list-style-type: none"> <li>• 100 ms, 200 ms, 500 ms, 1 s, 2 s, 5 s</li> </ul>	
	Control unit	Main Menu > Functions > Data > Recorder > Settings > Record interval
<b>Memory location</b>	The data stored in the control unit can be saved to a USB stick. The memory in the control unit is limited to the recording of a 24-hour measurement.	
	<ul style="list-style-type: none"> <li>• USB flash drive</li> <li>• Control unit</li> </ul>	
	Control unit	Main Menu > Functions > Data > Recorder > Settings > Storage location
<b>Copy data</b>	The data stored in the control unit can be saved to a USB stick. The memory in the control unit is limited to the recording of a 24-hour measurement.	
	<ul style="list-style-type: none"> <li>• USB flash drive</li> <li>• Control unit</li> </ul>	
	Control unit	Main Menu > Functions > Data > Recorder > Copy > Copy files
<b>Deleting data</b>	The data stored in the control unit can be saved to a USB stick. The memory in the control unit is limited to the recording of a 24-hour measurement.	
	<ul style="list-style-type: none"> <li>• USB flash drive</li> </ul>	

• Control unit	
Control unit	Main Menu > Functions > Data > Recorder > Delete > Delete files

## 6.7 Copying measurement data, deleting measurement data

The measurement data can be saved to a USB stick, see Device setup [▶ 14].

- "Main Menu > Functions > Data > Recorder > Copy > Copy files"
- "Main Menu > Functions > Data > Recorder > Delete > Delete files"

## 6.8 Updating the software

Software updates from INFICON are installed with the aid of a USB flash drive. The update function of the device can be found under "Functions > Data > Update".

An update is possible,

- if one or several updates are available on the USB-Stick, but only one update per type at most (control unit, MSB box, I/O module),
- if these parts are also connected free of disturbances and have an update function.

The corresponding buttons in the update menu such as "Control Unit", "MSB Box", and "I/O Module" are active and can be activated individually.

### NOTICE

#### Aborted connection

Data loss due to an aborted connection

- ▶ Do not switch off the device and do not remove the USB flash drive while the software is being updated!
- ▶ Switch the device off and back on after a software update has taken place.

### 6.8.1 Updating the software of the control unit

The software is included in two files named Handset\_IFC\_Vx.xx.xx.exe and Handset\_IFC\_Vx.xx.xx.key.

- 1 Copy the file into the main directory of a USB flash drive.
- 2 Connect the USB flash drive to the USB port on the device.
- 3 Select: Functions > Data > Update.



- ⇒ Do not switch off the device and do not remove the USB flash drive while the software is being updated!
- 4** Check the version information.
- 5** Select the "Start" button to start the update. Do not switch off the device and do not remove the USB flash drive while the software is being updated!
- 6** Follow the instructions on the touchscreen and wait until the update is complete.

## 6.8.2 Updating the software of the I/O module

The software of the I/O module can be updated from the control unit if the mass spectrometer module has the software version "MS module 1.02" or higher.

- 1** Copy the file `Flash_LDS3000_IO_Vxx.xx.xxx.bin` into the main directory of a USB flash drive.
- 2** Connect the USB flash drive to the USB port on the device.
- 3** Select: "Functions > Data > Update > I/O module"
  - ⇒ The display shows information on the current and the new software as well as on the current boot loader.
- 4** Check the version information.
- 5** Select the "Start" button to start the update.
  - ⇒ Do not switch off the device and do not remove the USB flash drive while the software is being updated!
- 6** Follow the instructions on the touchscreen and wait until the update is complete.
  - ⇒ The following tips are shown after selecting the "Start" button on the touchscreen:
    - Connect and switch on the IO1000.
    - Activate boot mode (switch DIP S2.3 on and off once).
    - When the STATUS LED flashes green, press OK.

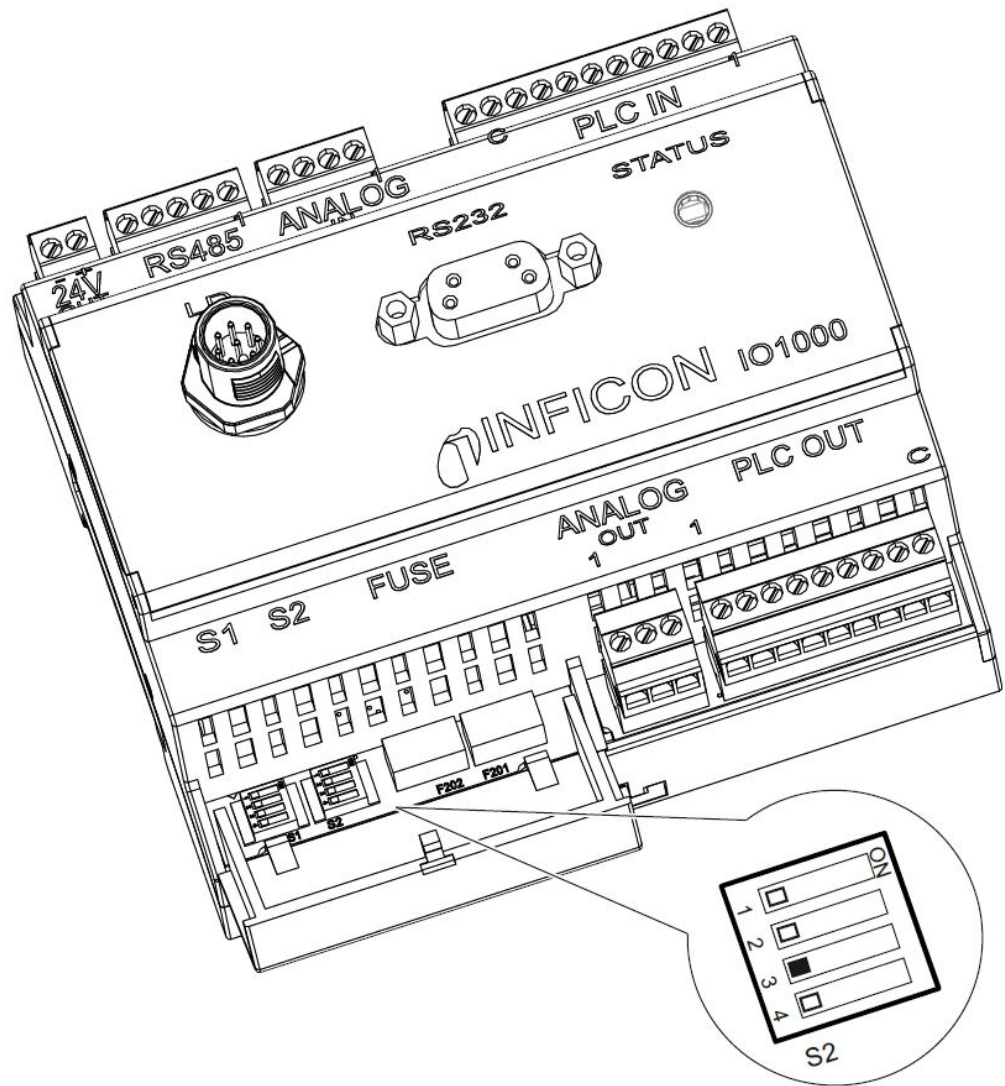

Fig. 6: DIP switch on the I/O module

## 6.9 Calling up information

Different information and states of the system can be called up with the info menu.

### Measurement values

- Preamplifier
- Environment
- TMP

### Temperature

- Electronic
- TMP

### Energy and operating hours

- Energy values: Information on consumption values
- Operation hours: Display for operating hours
- Supply voltages: Information on internal supply voltages
- Power supply: Information on the supply voltages of the components

### History

- Error, error history / warning history

- 
- Calibration, calibration history
  - TMP error, TMP history
  - Warnings, active warnings
  - Maintenance, maintenance history
- Control unit**
- Version control unit: Information on the software version
  - Memory: Information on available memory
  - Settings: Control unit settings.
  - Serial port wired: Information on the communication connection
  - Data exchange: Information on the data exchange between mass spectrometer module and the control unit
- Mass spectrometer module**
- MSB (1): Information on the software version
  - MSB (2): Information on operating parameters
  - TMP controller (1): Information on the turbo molecular pump
  - TMP controller (2): Information on the turbo molecular pump, continued
  - Ion source: Information on the ion source used
  - Preamplifier: Information on the preamplifier
  - Preamplifier test: Information on the preamplifier test.
- Interfaces**
- I/O module (1): Information on the software version, inputs and outputs
  - I/O module (2): Visualized information to the digital inputs

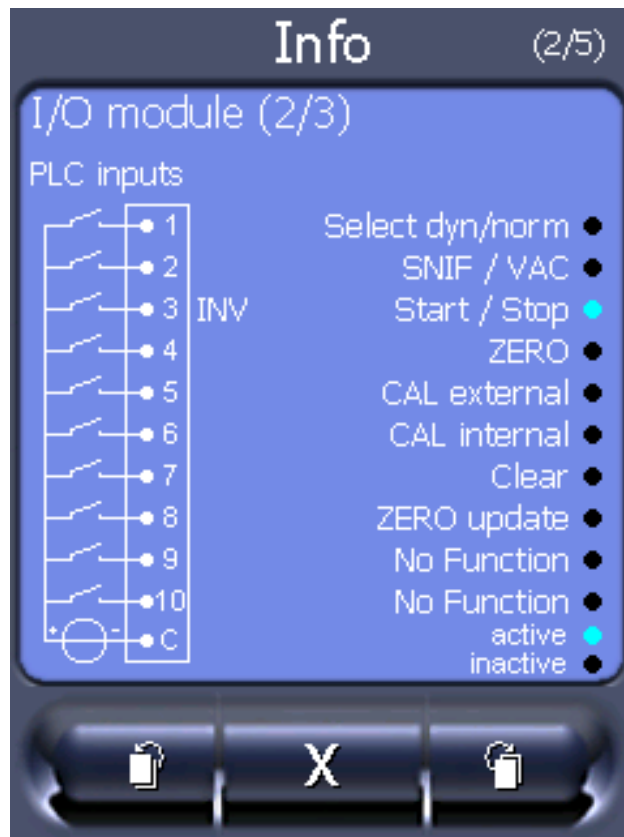

Fig. 7: I/O module (2): Visualized information to the digital inputs

1	Input signal condition	2	Configured function (INV = Function is inverted)
3	Status of the function (active or inactive)		

- I/O module (3): Visualized information to the digital outputs

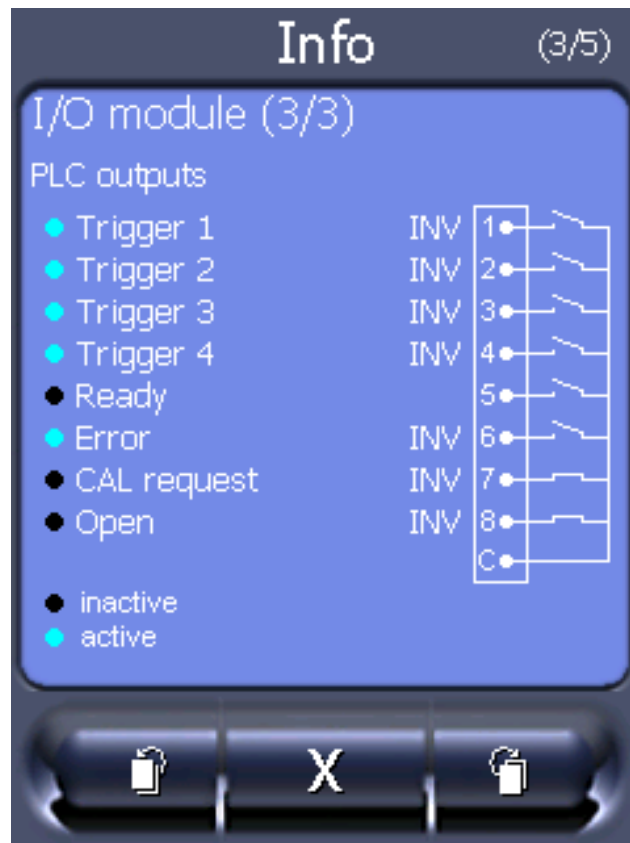

Fig. 8: Visualized information to the digital outputs

1	Configured function (INV = Function is inverted)	2	Output signal condition
3	Status of the function (active or inactive)		

- Bus module (1): Information on the bus module
- Bus module (2): Information on the bus module, continued

## 6.10 Display, save, load parameters

### Parameter list display and change

Parameters can be displayed as an alphabetical list with names and current value s. Each list entry is a button which, when pressed, will open the parameter's set-up dialog box.

Control unit	Main Menu > List > Parameters list or: Main Menu > Functions > Data > Parameters > List
--------------	--

### Display list of parameter change authorizations

Parameters can be displayed as an alphabetical list with names and current change authorizations. Each list entry is a button which, when pressed, will change access control. Changes are possible in accordance with the hierarchy of the operator.

Control unit	Main Menu > Functions > Data > Parameters > Parameter Access
--------------	--

**Loading or saving parameters**

To save and restore the parameters of the device, you can connect a USB stick to the front of the device.

Save parameter:

- Main Menu > Functions > Data > Parameters > Save

Loading parameters:

- Main Menu > Functions > Data > Parameters > Load

## 6.11 Resetting the settings

**Mass spectrometer module**

The settings of the mass spectrometer module can be reset to factory settings.

0	Load factory settings
10	(Not applicable for XL3000flex!)
11	(Not applicable for XL3000flex!)
12	Reset the settings for XL sniffer adapter mode

Control unit	Functions > Data > Parameters > Reset > MSB settings
--------------	--

LD protocol	Command 1161
-------------	--------------

ASCII protocol	Command *RST:FACTORY
----------------	----------------------

–

–

	Command *RST:SL3000
--	---------------------

**Access controls**

The authorization for changing parameters can be reset to factory setting.

Control unit	Main Menu > Functions > Data > Parameters > Reset > Parameter Access
--------------	--

**Control unit**

The control unit settings can be reset to factory settings.

Control unit	Main Menu > Functions > Data > Parameters > Reset > Control unit settings
--------------	---

## 7 Warning and error messages

The instrument is equipped with extensive self-diagnostic functions.

### Error messages

Errors are events that the device cannot correct itself and that force interruption of its operation. The error message consists of a number and a descriptive text.

After you have removed the cause of the error, start operation again with the restart key.

### Warnings

Warnings warn of device states that can impair the accuracy of measurements.

Operation of the device is not interrupted.

Confirm acknowledgment of the warning with the OK key or the right key on the sniffer handle.

The following table displays all the warnings and error messages. It lists possible causes for the malfunction and instructions on how to eliminate these.

Please note that work marked with an asterisk must be carried out only by service staff that is authorized by INFICON.

Warning (Wrn) Error (Err)	Error message	Error number		Limit values	Cause
		LDS1000 Protocol	Binary or ASCII protocol compatibility mode LDS1000/LDS2010		
<b>1xx system error (RAM, ROM, EEPROM, clock, ...)</b>					
Wrn102	Timeout EEPROM MSB Box (Parameter number)	84	43		EEPROM on IF board or MSB defective
Wrn104	An EEPROM parameter is initializing	84	43		Following software update or EEPROM defective
Wrn106	EEPROM parameter initializing	84	43		Following software update or EEPROM defective
Wrn110	Clock not set	16	16		Jumper for clock not set, battery drained, clock defective
Wrn122	No response from the BUS module	99	99		Connection to BUS module interrupted
Wrn123	Unsupported configuration INFICON from BM1000	99	99		The selected configuration is not supported by the connected INFICON BM1000-fieldbus type.

Warning (Wrn) Error (Err)	Error message LDS3000	Error number		Limit values	Cause
		LDS1000 Protocol	Binary or ASCII protocol compatibility mode LDS1000/ LDS2010		
Wrn125	I/O module not connected	99	99		Connection to I/O module interrupted
Wrn127	Wrong bootloader version	99	99		Boot loader not compatible with application
Err129	Incorrect device (EEPROM)	99	99		EEPROM does not contain any compatible data
Err130	Sniffer not connected	99	99		The sniffer line is not connected.
Wrn132	SL3000 not supported				Only the SL3000XL may be used with the XL3000flex
Wrn150	Pressure sensor 2 is not connected	–	–		Connecting pressure sensor PSG500 to a FINE connection.
<b>2xx operating voltage error</b>					
Wrn201	U24_MSB too low	24	120	21.6V	24V power supply pack
Wrn202	U24_MSB too high	24	120	26.4V	24V power supply pack
Wrn203	24V_PWR12 voltage out of range (TL_valve/GB_valve)	24	120	20V 30V	Short circuit at valve 1 (calibrated leak) or valve 2 (gas ballast)
Wrn204	24V_PWR34 voltage out of range (valve 3/4)	24	120	20V 30V	Short circuit at valve 3 or valve 4
Wrn205	24V_PWR56 voltage out of range (Sniff_valve/valve6)	24	120	20V 30V	Short circuit at valve 5 (sniff) or valve 6
Wrn221	Internal voltage 24V_RC voltage out of range	24	120	20V 30V	Short circuit 24V at the control unit output
Wrn222	Internal voltage 24V_IO voltage out of range	24	120	20V 30V	Short circuit 24V at IO output
Wrn223	Internal voltage 24V_TMP voltage out of range	24	120	20V 30V	Short circuit 24V of the TMP
Wrn224	Internal voltage 24V_1 (Pirani) voltage out of range	24	120	20V 30V	Short circuit 24V Pressure sensor PSG500 (1,2,3), sniffer line



Warning (Wrn) Error (Err)	Error message LDS3000	Error number		Limit values	Cause
		LDS1000 Protocol	Binary or ASCII protocol compatibility mode LDS1000/LDS2010		
Wrn240	Voltage +15V out of range	24	120		+15V too low, IF board or MSB defective
Wrn241	Voltage -15V out of range	24	120		-15V too low, short circuit at preamplifier, IF board or MSB defective
Err242	+15V or -15V voltage shorted	24	120		+15V or -15V too low, short circuit at preamplifier, IF board or MSB defective
Wrn250	REF5V voltage out of range	24	120	4.5V 5.5V	+15V or 5V too low, short circuit at preamplifier, IF board or MSB defective
Err252	REF5V voltage shorted	24	120		+15V or REF5V too low, short circuit at preamplifier, IF board or MSB defective
<b>3xx detection system (offset preamplifier, preamplifier test, emission, cathode test)</b>					
Wrn300	Anode voltage too low	41	132	7V < the setpoint	Short circuit anode voltage, pressure in mass spectrometer too high, IF board, MSB or ion source defective
Wrn301	Anode voltage too high	40	131	7V > the setpoint	MSB defective
Wrn302	Suppressor voltage too low	39	130	297V	Short circuit suppressor, IF board or MSB defective
Wrn303	Suppressor voltage too high	38	129	363V	MSB defective
Wrn304	Anode-cathode voltage too low	36	127	40V	Short circuit anode-cathode, IF board or MSB defective
Wrn305	Anode-cathode voltage too high	35	126	140V	MSB defective

Warning (Wrn) Error (Err)	Error message LDS3000	Error number		Limit values	Cause
		LDS1000 Protocol	Binary or ASCII protocol compatibility mode LDS1000/ LDS2010		
Err306	Anode voltage faulty	36	127	40 V deviation from the default value	The anode voltage does not match the default value or the set value is outside the allowable setting range.
Wrn310	Cathode 1 is defective	45	136		Cathode defective, line to cathode interrupted, IF board or MSB defective
Wrn311	Cathode 2 is defective	46	137		Cathode defective, line to cathode interrupted, IF board or MSB defective
Err312	Cathode defective	47	138		Cathode defective, line to cathode interrupted, IF board or MSB defective
Err340	Emission error	44	135	< 90% of the target value > 110% of the target value	Emission was stable previously, pressure probably too high, message after 15s
Wrn342	Cathode not connected	47	138		Both cathodes defective during self-testing after switch on or plug not connected
Wrn350	Suppressor not connected	39	130		Suppressor cable is not plugged in or defective during the self-test after switching on
Wrn352	Preamplifier not connected				Preamplifier defective, cable not plugged in
Err358	Preamplifier oscillates between 2 ranges				Signal varies too much (see command 1120) Preamplifier defective
Wrn359	Overdriven preamplifier	31	123		Signal too large preamplifier defective

Warning (Wrn) Error (Err)	Error message LDS3000	Error number		Limit values	Cause
		LDS1000 Protocol	Binary or ASCII protocol compatibility mode LDS1000/ LDS2010		
Wrn360	Preamplifier output too low	31	123	<-70 mV at 500 GΩ	Poor ion source or contaminated mass spectrometer
Wrn361	Preamplifier offset too high	31	123	>+/-50 mV at 500 GΩ, >+/-10 mV at 15 GΩ, <+/-10 mV at 470 MΩ, <+/-9 mV at 13 MΩ	Preamplifier defective
Wrn362	Preamplifier range error	31	123		Preamplifier or MSB box defective
Wrn390	500 G outside the range	31	123	450 GΩ 550 GΩ	Preamplifier defective, error at the suppressor, IF board or MSB defective
<b>4xx TMP fault (also temperature)</b>					
Err400	TMP fault number	49	15		
Wrn401	TMP warning number				
Err402	No communication with TMP	49	15		Cable to TMP / TMP defective, IF board or MSB defective
Err403	TMP rotation speed too low	53	142	< 95% of the target value	Pressure too high, TMP defective
Err404	TMP current consumption too high	49	2	3A	
Err405	No TMP run-up time	60	61	5 min.	Pressure too high, TMP faulty
Err410	TMP temperature too high	49	2	61°C	Cooling failed, check MSB module operating conditions
Wrn411	High TMP temperature	49	2	60°C	Cooling failed, check MSB module operating conditions
Err420	TMP voltage too high	49	2		Power supply defective, TMP defective

Warning (Wrn) Error (Err)	Error message LDS3000	Error number		Limit values	Cause
		LDS1000 Protocol	Binary or ASCII protocol compatibility mode LDS1000/ LDS2010		
Wrn421	TMP voltage too low				Cable cross-section 24 V supply for MSB modules too low, output current 24-V power supply too low (I < 10 A), power supply defective, TMP defective
Err422	TMP no run-up time	49	2	8 min.	TMP foreline pressure too high, VV pump final pressure too high, leakage high vacuum system, flood valve not close, TMP bearing damage, TMP flawed
Err423	TMP pressure rise	49	2		Inrush of air, flood valve defective or incorrectly dimensioned

#### 5xx Pressure and flow errors

Wrn500	Pressure sensor not connected	58	144	0.5V	Pressure sensor PSG500 P1 not connected, IF board or MSB defective
Wrn502	Pressure sensor 2 not connected				Pressure sensor PSG500 P2 not connected, IF board or MSB defective.
Wrn520	Pressure too high	73	148	18 mbar	Pressure p1 too high
Wrn521	Pressure rise, anode voltage collapse	73	148	< Setpoint - 20V	Pressure p1 too high, message after 1.4s
Wrn522	Pressure rise, emission collapsed	73	148	< 90% of the target value > 110% of the target value	Emission was stable previously, pressure p1 too high, message after 5s
Wrn540	Pressure too low, Sniffer blocked	63	62	Sniffer flow warning parameter	Sniffer clogged, sniffer valve defective, filter clogged

Err541	Sniffer blocked (p1)	62	146		Sniffer blocked, sniffer valve defective (pressure lower than half of the configured warning value), filter clogged
Wrn542	Sniffer broken	64	147		Sniffer broken
Wrn550	Pressure too low, XL Sniffer blocked				Clean or replace the high flow capillary of the sniffer line. Replace soiled filter.
Wrn552	XL Sniffer broken				Replace the high flow capillary of the sniffer line.
Wrn554	XL Sniffer P2 too small	63	62		Pressure on SL3000XL too low in low flow.
<b>6xx Calibration errors</b>					
Wrn600	Calibration factor too low	81	153	0.01	Calibration leak or machine factor set incorrectly
Wrn601	Calibration factor too high	81	153	10000	Calibrated leak or machine factor set incorrectly, partial flow factor too high
Wrn602	KalFaktor lower than last calibration	81	153	< 50% of the old value	Calibrated leak, machine factor or partial flow factor has changed
Wrn603	KalFaktor higher than last calibration	81	153	> 200% of the old value	Calibrated leak, machine factor or partial flow factor has changed
Wrn604	Int. Cal. not possible, lack of calibration leak control	81	153		calibration leak is not enabled
Wrn605	Difference during calibration too small				Calibration leak defective or signal too weak.
Wrn610	Machine factor too low	81	153	1.00E-04	Machine factor adjustment inaccurate
Wrn611	Machine factor too high	81	153	1.00E+04	Machine factor adjustment inaccurate, partial flow factor too high
Wrn612	Machine factor lower than last time	81	153	< 50% of the old value	Partial flow factor has changed
Wrn613	Machine factor greater than last time	81	153	> 200% of the old value	Partial flow factor has changed

Wrn625	Int. calibration leak not set	0	0		Leak rate of int. calibration leak is still set to factory setting
Wrn626	Ext. Calibration leak not set	0	0		Leak rate of calibration leak is still set to factory setting
Wrn630	Calibration request	0	0		Temperature change of 5°C, Rotation speed was changed since last calibration, 30-minute switch-on time and still no calibration conducted
Wrn650	Calibration is not recommended in the first 20 minutes				A calibration during the first 20 minutes after starting (warm-up phase) the leak detector is not recommended.  The warning message can be turned off: - LD protocol: Bef 429 - ASCII *CONFig:CALWarn (ON,OFF)
Wrn670	Calibration error	81	153		Since a problem has occurred during the calibration, you have to recalibrate.
Wrn671	Peak not found	81	153		The signal was too restless during the peak search. Calibration has been aborted.
Wrn680	Deviation to the calibration detected	0	0		The verification of calibration has shown that you should recalibrate.
<b>7xx temperature errors (preamplifier, electronics)</b>					
Wrn700	Preamplifier temp. too low	33	60	2°C	Temperature too low
Wrn702	Preamplifier temp. too high	32	124	60°C	Temperature too high
Wrn710	MSB temperature too high	54	44	58°C	Temperature too high
Err711	Max. MSB temperature exceeded	54	44	65°C	Temperature too high
<b>8xx not used</b>					
<b>9xx maintenance messages (e.g. TMP)</b>					
Wrn901	Maintenance bearing/lubricant	99	99	3 years	TMP maintenance necessary
Wrn910	Maintenance diaphragm pump	99	99		8000 hour maintenance of diaphragm pump required

## 8 Cleaning and maintenance

All cleaning and maintenance work described here must be carried out without opening the device!

### **WARNING**

#### **Life threatening hazard from electric shock**

High voltages are inside the device. Touching parts where electrical voltage is present can result in death.

- ▶ Disconnect the device from the power supply prior to any installation and maintenance work. Ensure that the electrical supply cannot be switched back on unintentionally.

### 8.1 Cleaning the housing

Wipe the housing with a soft damp cloth.

Use only water to moisten. Avoid cleaners that contain alcohol, fat or oil.

### 8.2 Maintenance of the XL3000flex

For your safety, we recommend to contact your INFICON Service for any maintenance that needs to opening the device.

You can change yourself the fuses, the filter mats of the fan inlet and the filter in the sniffer tip without opening the device.

#### 8.2.1 Change the filter mat of the fan input

Depending on the location, the filter mat on the back of the device may become dirty. Check the filter mat periodically and change it, if the filter mat is significant dirty.

✓ You have a new filter set.

- 1 Make sure that the device is disconnected from the power supply by pulling the power plug securely.
- 2 Gently lift the lower corners of the plastic grid and remove the plastic grid with the filter mat.
- 3 Replace the dirty filter set.

## 8.2.2 Replacing the fuses

### DANGER

#### Life threatening hazard from electric shock

- ▶ Disconnect the device from the power supply.
- ▶ Ensure that the electrical supply cannot be switched back on unintentionally.

- 1 Switch off the device and disconnect from the mains.
- 2 Pull the plug of the power cable out of the device.
- 3 The fuse holder of the device is located under a cover next to the power switch. Carefully remove the cover with the fuses attached underneath out of the device.
- 4 Remove the fuses and check them for any damage.
- 5 If necessary, replace the fuses. Use only spare fuses of the same type and rating as those supplied (T6.3 A 250 V).
- 6 Two fuses of the same type must be used.
- 7 Press the fuse holder along with the fuses back into the starting position until the cover locks into place.

## 8.2.3 Replacing the filter cartridge on the sniffer probe

The replacement interval depends on the ambient conditions. The filter cartridge must generally be replaced every 500 to 1500 operating hours.

The filter cartridge is in the sniffer probe.



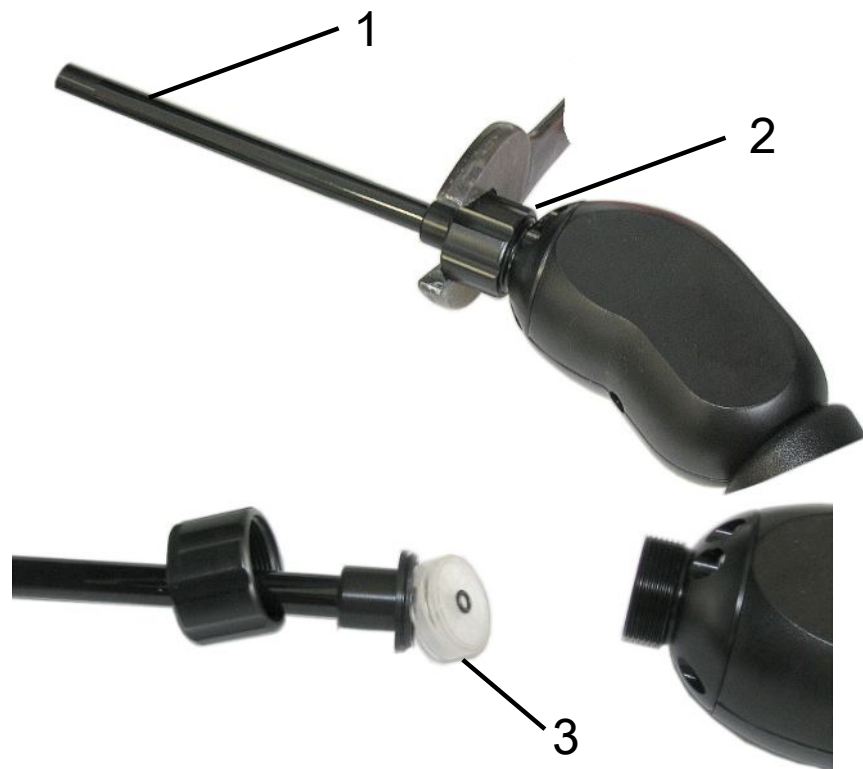

Position	Description
1	Sniffer tip
2	Cap nut
3	Filter cartridge

- 1 Remove the sniffer probe: Release the cap nut of the sniffer probe manually or with a screw driver (SW21).
- 2 Remove the old filter cartridge and insert a new filter cartridge.
- 3 Put the sniffer probe on the handle and tighten the cap nut manually only.
- 4 Check for tightness:

If no air can be drawn in, the unit signals the warning W41. If the end of the sniffer tip is closed and the warning is not reported, the screw connection at the sniffer tip is leaking or the filter cartridge is not seated correctly.

- 1 Unscrew the plastic cap on the end of the filter tip.
- 2 Close the end of the sniffer probe with the thumb. If there is no warning, tighten the cap nut and – if that is not successful – check the seat of the filter.
- 3 Tighten the plastic cap on the end the sniffer probe again.
- 4 Calibrating the device

## 8.2.4 Sending for repair or maintenance

Maintenance inside the device may only be performed by the manufacturer. We recommend having the device serviced periodically by the manufacturer's service.

You can send in your device to INFICON so it can be maintained or repaired. For further details see "Sending in the device [▶ 91]".

## 8.2.5 Maintenance plan

Assembly	Maintenance Work XL3000flex	Operating hours/years (intervals are repeated)						Service level	Spare part number
		2000	4000	8000	16000	24000	32000		
		1/4	1/2	1	2	3	4		
SplitFlow 80	Changing the lubricant reservoir				X <sub>3</sub>			II	200003801
	Change bearings and replace oil wick cartridge						X <sub>2</sub>	III	
Inspecting and cleaning the fan function				X <sub>3</sub>				II	
Diaphragm pump	Replacing the diaphragms valves plates and O-Rings			X <sub>1</sub>				III	200005414
Leak Detection MSB module	Performing helium leak detection on the MSB module			X				III	
Sniffer line filters	Replacing the sniffer line filters	X <sub>3</sub>						II	521-023
Air filter	Replacing the air filter on housing			X <sub>3</sub>				I	200008670

Explanation of the maintenance plan:

- I Service level I Customer
- II Service level II Customer with technical training
- III Service level III Authorized INFICON service technician
- X Carry out maintenance as per operating hours or duration
- X<sub>1</sub> Maintenance after operating hours, not after duration
- X<sub>2</sub> Maintenance by duration, not by operating hours
- X<sub>3</sub> Dependent on environmental influences, operating conditions, contamination and application process

# 9 Decommissioning the measuring instrument

## 9.1 Sending in the device

---

**⚠ WARNING****Danger due to harmful substances**

Contaminated devices could endanger the health. The contamination declaration serves to protect all persons who come into contact with the device.

- ▶ Fill in the declaration of contamination completely.

- 
- 1** Please do not hesitate to contact the manufacturer and send a completed declaration of contamination before sending anything to us.  
⇒ You will then receive a return number.
  - 2** Use the original packaging when returning.
  - 3** Before sending the device, attach a copy of the completed contamination declaration. See below.

# Declaration of Contamination

The service, repair, and/or disposal of vacuum equipment and components will only be carried out if a correctly completed declaration has been submitted. Non-completion will result in delay. This declaration may only be completed (in block letters) and signed by authorized and qualified staff.

**1 Description of product**

Type \_\_\_\_\_

Article Number \_\_\_\_\_

Serial Number \_\_\_\_\_

**2 Reason for return**

\_\_\_\_\_

\_\_\_\_\_

**3 Operating fluid(s) used (Must be drained before shipping.)**

\_\_\_\_\_

**4 Process related contamination of product:**

toxic	no <input type="checkbox"/> 1)	yes <input type="checkbox"/>	
caustic	no <input type="checkbox"/> 1)	yes <input type="checkbox"/>	
biological hazard	no <input type="checkbox"/>	yes <input type="checkbox"/> 2)	
explosive	no <input type="checkbox"/>	yes <input type="checkbox"/> 2)	
radioactive	no <input type="checkbox"/>	yes <input type="checkbox"/> 2)	
other harmful substances	no <input type="checkbox"/> 1)	yes <input type="checkbox"/>	

2) Products thus contaminated will not be accepted without written evidence of decontamination!

The product is free of any substances which are damaging to health  
yes

1) or not containing any amount of hazardous residues that exceed the permissible exposure limits

**5 Harmful substances, gases and/or by-products**

Please list all substances, gases, and by-products which the product may have come into contact with:

Trade/product name	Chemical name (or symbol)	Precautions associated with substance	Action if human contact

**6 Legally binding declaration:**

I/we hereby declare that the information on this form is complete and accurate and that I/we will assume any further costs that may arise. The contaminated product will be dispatched in accordance with the applicable regulations.

Organization/company \_\_\_\_\_

Address \_\_\_\_\_ Post code, place \_\_\_\_\_

Phone \_\_\_\_\_ Fax \_\_\_\_\_

Email \_\_\_\_\_

Name \_\_\_\_\_

Date and legally binding signature \_\_\_\_\_ Company stamp \_\_\_\_\_

Copies:  
Original for addressee - 1 copy for accompanying documents - 1 copy for file of sender

## 10 Gas library

The operating software of the device contains a list of approx. 100 gases which could be relevant in the refrigeration industry.

The list is stored in the nonvolatile flash memory of the operating unit and can be updated. The user can access this list while pre-defining the equivalence gases, see "Configure gas list [▶ 56]". The user can then select from the pre-defined gases during gas equivalent selection, see "Gas equivalent selection [▶ 56]".

The library of the device has the following factory-defined content:

Gas designation (max. 8 digits)	Other designations	Molecular mass (amu)	Helium viscosity factor	Hydrogen/mass 3 viscosity factor
R11	$\text{CFCl}_3$	137.4	0.515	1.15
R12	$\text{CF}_2\text{Cl}_2$	120.9	0.591	1.319
R12B1	$\text{CF}_2\text{ClBr}$ Halon 1211	165.4	0.523	1.167
R13	$\text{CF}_3\text{Cl}$	104.5	0.857	1.913
R13B1	$\text{CF}_3\text{Br}$ Halon 1301	149	0.852	1.902
R14	$\text{CF}_4$	80	0.857	1.913
R21	$\text{CHFCl}_2$	102.9	0.535	1.194
R22	$\text{CHF}_2\text{Cl}$	86.5	0.632	1.411
R23	$\text{CHF}_3$	70	0.704	1.571
R32	$\text{CH}_2\text{F}_2$	52	0.632	1.411
R41	$\text{CH}_3\text{F}$	34	0.551	1.23
R50	$\text{CH}_4$ Methane	16	0.556	1.241
R113	$\text{C}_2\text{F}_3\text{Cl}_3$	187.4	0.484	1.08
R114	$\text{C}_2\text{F}_4\text{Cl}_2$	170.9	0.545	1.217
R115	$\text{C}_2\text{F}_5\text{Cl}$	154.5	0.627	1.4
R116	$\text{C}_2\text{F}_6$	138	0.709	1.583
R123	$\text{C}_2\text{HF}_3\text{Cl}_2$	152.9	0.54	1.205
R124	$\text{C}_2\text{HF}_4\text{Cl}$	136.5	0.581	1.297
R125	$\text{C}_2\text{HF}_5$	120	0.653	1.458
R134a	$\text{C}_2\text{H}_2\text{F}_4$	102	0.591	1.319
R141b	$\text{C}_2\text{H}_3\text{FCl}_2$	117	0.464	1.036
R142b	$\text{C}_2\text{H}_3\text{F}_2\text{Cl}$	100.5	0.494	1.103
R143a	$\text{C}_2\text{H}_3\text{F}_3$	84	0.561	1.252
R152a	$\text{C}_2\text{H}_4\text{F}_2$	66.1	0.515	1.15

Gas designation (max. 8 digits)	Other designations	Molecular mass (amu)	Helium viscosity factor	Hydrogen/mass 3 viscosity factor
R170	C <sub>2</sub> H <sub>6</sub> Ethane	30.1	0.479	1.069
R218	C <sub>3</sub> F <sub>8</sub>	188	0.627	1.4
R227ea	C <sub>3</sub> HF <sub>7</sub>	170	0.627	1.4
R236fa	C <sub>3</sub> H <sub>2</sub> F <sub>6</sub>	152	0.55	1.228
R245fa	C <sub>3</sub> H <sub>3</sub> F <sub>5</sub>	134	0.52	1.161
R290	C <sub>3</sub> H <sub>8</sub> Propane	44.1	0.433	0.967
R356	C <sub>4</sub> H <sub>5</sub> F <sub>5</sub>	166.1	0.561	1.252
R400	Mixture of 50% R12 50% R114	141.6	0.571	1.275
R401A	Mixture of 53% R22 13% R152a 34% R124	94.4	0.607	1.355
R401B	Mixture of 61% R22 11% R152a 28% R124	92.8	0.612	1.366
R401C	Mixture of 33% R22 15% R152a 52% R124	101	0.602	1.344
R402A	Mixture of 38% R22 60% R125 2% R290	101.6	0.647	1.444
R402B	Mixture of 60% R22 38% R125 2% R290	94.7	0.642	1.433
R403A	Mixture of 75% R22 20% R218 5% R290	92	0.642	1.433

Gas designation (max. 8 digits)	Other designations	Molecular mass (amu)	Helium viscosity factor	Hydrogen/mass 3 viscosity factor
R403B	Mixture of 56% R22 39% R218 5% R290	103.3	0.647	1.444
R404A	Mixture of 44% R125 52% R143a 4% R134a	97.6	0.607	1.355
R405A	Mixture of 45% R22 7% R152a 5.5% 142b 42.5% RC318	111.9	0.622	1.388
R406A	Mixture of 55% R22 4% R600a 41% R142b	89.9	0.566	1.263
R407A	Mixture of 20% R32 40% R125 40% R134a	90.1	0.637	1.422
R407B	Mixture of 10% R32 70% R125 20% R134a	102.9	0.647	1.444
R407C	Mixture of 10% R32 70% R125 20% R134a	86.2	0.627	1.4
R407D	Mixture of 23% R32 25% R125 52% R134a	91	0.612	1.366
R407E	Mixture of 25% R32 15% R125 60% R134a	83.8	0.622	1.388

Gas designation (max. 8 digits)	Other designations	Molecular mass (amu)	Helium viscosity factor	Hydrogen/mass 3 viscosity factor
R407F	Mixture of 40% R134a 30% R125 30% R32	82.1	0.67	1.496
R408A	Mixture of 7% R125 46% R143a 47% R22	87	0.602	1.344
R409A	Mixture of 60% R22 25% R124 15% R142b	97.4	0.607	1.355
R409B	Mixture of 65% R22 25% R124 10% R142b	96.7	0.612	1.366
R410A	Mixture of 50% R32 50% R125	72.6	0.673	1.502
R410B	Mixture of 45% R32 55% R125	75.6	0.673	1.502
R411A	Mixture of 1.5% R1270 87.5% R22 11% R152a	82.4	0.617	1.377
R411B	Mixture of 3% R1270 94% R22 3% R152a	83.1	0.62	1.388
R411C	Mixture of 3% R1270 95.5% R22 1.5% R152a	83.4	0.627	1.4
R412A	Mixture of 70% R22 5% R218 25% R142b	92.2	0.602	1.344



Gas designation (max. 8 digits)	Other designations	Molecular mass (amu)	Helium viscosity factor	Hydrogen/mass 3 viscosity factor
R413A	Mixture of 9% R218 88% R134a 3% R600	104	0.581	1.297
R414A	Mixture of 51% R22 28.5% R124 4% R600a 16.5% R142	96.9	0.586	1.308
R415A	Mixture of 82% R22 18% R152a	81.7	0.622	1.388
R416A	Mixture of 59% R134a 39.5% R124 1.5% R600	111.9	0.576	1.286
R417A	Mixture of 50% R134a 46% R125 4% R600a	106.7	0.61	1.362
R422D	Mixture of 65.1% R125 31.5% R134a 3.4% R600a	112.2	0.622	1.388
R438A	Mixture of 45% R125 44.2% R134a 8.5% R32 1.7% R600 0.6% R601a	104.9	0.617	1.377
R441A	Mixture of 54.8% R290 36.1% R600 6% R600a 3.1% R170	49.6	0.398	0.888
R442A	Mixture of 31% R32 31% R125 30% R134a 5% R227ea 3% R152a	81.8	0.629	1.404

Gas designation (max. 8 digits)	Other designations	Molecular mass (amu)	Helium viscosity factor	Hydrogen/mass 3 viscosity factor
R448A	Mixture of 26% R32 26% R125 21% R134a 20% R1234yf 7% R1234ze	99.3	0.625	1.395
R449A	Mixture of 25.7% R134 25.3% R1234yf 24.7% R125 24.3% R32	87.2	0.622	1.388
R450A	Mixture of 58% R1234ze 42% R134a	109	0.592	1.321
R452A	Mixture of 59% R125 30% R1234yf 11% R32	103.5	0.612	1.366
R452B	Mixture of 67% R32 26% R1234yf 7% R125	72.9	0.639	1.426
R454C	Mixture of 22% R32 78% R1234yf	90.8	0.62	1.384
R500	Mixture of 74% R12 26% R152a	99.3	0.581	1.297
R501	Mixture of 75% R22 25% R12	93.1	0.627	1.4
R502	Mixture of 49% R22 51% R115	111.6	0.647	1.444
R503	Mixture of 40% R23 60% R13	87.3	0.709	1.583

Gas designation (max. 8 digits)	Other designations	Molecular mass (amu)	Helium viscosity factor	Hydrogen/mass 3 viscosity factor
R504	Mixture of 48% R32 52% R115	79.3	0.678	1.513
R505	Mixture of 78% R12 22% R31	103.5	0.612	1.366
R506	Mixture of 55% R31 45% R114	93.7	0.561	1.252
R507	Mixture of 50% R125 50% R143a	98.9	0.612	1.366
R508A	Mixture of 39% R23 61% R116	100.1	0.729	1.627
R508B	Mixture of 46% R23 54% R116	95.4	0.729	1.627
R513A	Mixture of 44% R134a 56% R1234yf	108.7	0.582	1.299
R600	C <sub>4</sub> H <sub>10</sub> Butane	58.1	0.377	0.842
R600a	C <sub>4</sub> H <sub>10</sub> Iso-Butane	58.1	0.377	0.842
R601	C <sub>5</sub> H <sub>12</sub> Pentane	72.2	0.341	0.761
R601a	C <sub>5</sub> H <sub>12</sub> Iso-Pentane	72.2	0.336	0.75
R601b	C <sub>5</sub> H <sub>12</sub> Neopentane	72.2	0.337	0.752
R601c	C <sub>5</sub> H <sub>12</sub> Cyclopentane	70.1	0.337	0.752
R1233zd	C <sub>3</sub> H <sub>2</sub> ClF <sub>3</sub>	130.5	0.558	1.246
R1234yf	C <sub>3</sub> H <sub>2</sub> F <sub>4</sub>	114	0.624	1.393
R1234ze	C <sub>3</sub> H <sub>2</sub> F <sub>4</sub>	114	0.619	1.382
R1243zf	C <sub>3</sub> H <sub>3</sub> F <sub>3</sub>	96	0.6	1.339
Ar	Argon	40	1.127	2.516

Gas designation (max. 8 digits)	Other designations	Molecular mass (amu)	Helium viscosity factor	Hydrogen/mass 3 viscosity factor
CO <sub>2</sub>	R744	44	0.744	1.661
H <sub>2</sub>	Hydrogen	2	0.448	1
H <sub>2</sub> O	R718	18	0.459	1.025
He	Helium	4	1	2.232
HT135	Galden HT135	610	1	2.232
Kr	Krypton	84	1.275	2.846
N <sub>2</sub>	Nitrogen	28	0.892	1.991
Ne	Neon	20.2	1.586	3.54
NH <sub>3</sub>	R717	17	0.505	1.127
O <sub>2</sub>	Oxygen	32	1.03	2.299
SF <sub>6</sub>		146.1	0.765	1.708
Xe	Xenon	131.3	1.153	2.574
ZT130	Galden ZT130	497	1	2.232

Table 1: Gas library V3.24

# 11 Accessories

The parts listed below can additionally be ordered.

Designation	Catalog number
<b>BM1000</b>	
BM1000 PROFIBUS	560-315
BM1000 PROFINET IO	560-316
BM1000 DeviceNet	560-317
BM1000 EtherNet/IP	560-318
IO1000 module	560-310
Data cable 0.5 m	560-334
Data cable 5 m	560-335
Data cable 10 m	560-340
Control unit CU1000	560-320
SL3000XL-3, sniffer line 3m length	521-011
SL3000XL-5, sniffer line 5m length	521-012
SL3000XL-10, sniffer line 10m length	521-013
SL3000XL-15, sniffer line 15m length	521-014
Holder for sniffer line	525-006
Adapter customer sniffer line PROTEC P3000XL	521-015
Oil / Water Protection Tip for SL3000XL	521-016
Filter for Oil/Water Protection Tip	521-017
Sniffer tip ST312XL, 120 mm, rigid	521-018
Sniffer tip FT312XL, 120 mm, flexible	521-019
Sniffer tip ST385XL, 385 mm, rigid	521-020
Sniffer tip FT385XL, 385 mm, flexible	521-021
Sniffer tip FT250XL, 250 mm, flexible	521-022
Filter cartridge for SL3000XL (25x)	521-023

# 12 CE Declaration of Conformity



## EU Declaration of Conformity

We – INFICON GmbH - herewith declare that the products defined below meet the basic requirements regarding safety and health and relevant provisions of the relevant EU Directives by design, type and the versions which are brought into circulation by us.

In case of any products changes made without our approval, this declaration will be void

The products meet the requirements of the following Directives:

- **Directive 2014/30/EU (Electromagnetic Compatibility)**
- **Directive 2006/42/EC (Machinery)**
- **Directive 2011/65/EC (RoHS)**

Designation of the product:

**Helium & hydrogen leak detector**

Applied harmonized standards:

- **EN 61010-1:2010**
- **EN 61326-1:2012**  
**Class B according to EN 55011**
- **EN ISO 12100:2010**
- **EN IEC 63000:2018**

Models:

**XL3000flex**  
**XL3000flexRC**

Catalogue numbers:

**520-200**  
**520-201**

Authorised person to compile the relevant technical files:

René Bausch, INFICON GmbH, Bonner Strasse 498, D-50968 Cologne

Cologne, August 22<sup>nd</sup>, 2020

Dr. Dobler, President LDT

Cologne, August 22<sup>nd</sup>, 2020

Bausch, Research and Development

**INFICON GmbH**  
Bonner Strasse 498  
D-50968 Cologne  
Tel.: +49 (0)221 56788-0  
Fax: +49 (0)221 56788-90  
www.inficon.com  
E-mail: leakdetection@inficon.com

# 13 RoHS

## Restriction of Hazardous Substances (China RoHS)

### 有害物质限制条例（中国 RoHS）

		XL3000flex, XL3000flexRC: Hazardous Substance XL3000flex, XL3000flexRC: 有害物质				
Part Name 部件名称	Lead (Pb) 铅	Mercury (Hg) 汞	Cadmium (Cd) 镉	Hexavalent Chromium (Cr(VI)) 六价铬	Polybrominated biphenyls (PBB) 多溴联苯	Polybrominated diphenyl ethers (PBDE) 多溴联苯醚
Assembled printed circuit boards 组装印刷电路板	X	O	O	O	O	O
Throttles 节气门	X	O	O	O	O	O
Valve 阀门	X	O	O	O	O	O
Fan 风扇	X	O	O	O	O	O
<p>This table is prepared in accordance with the provisions of SJ/T 11364. 本表是根据 SJ/T 11364 的规定编制的。</p> <p>O: Indicates that said hazardous substance contained in all of the homogeneous materials for this part is below the limit requirement of GB/T 26572. O: 表示该部件所有均质材料中所含的上述有害物质都在 GB/T 26572 的限制要求范围内。</p> <p>X: Indicates that said hazardous substance contained in at least one of the homogeneous materials used for this part is above the limit requirement of GB/T 26572. X: 表示该部件所使用的均质材料中，至少有一种材料所含的上述有害物质超出了 GB/T 26572 的限制要求。</p> <p>(Enterprises may further provide in this box technical explanation for marking “X” based on their actual circumstances.) (企业可以根据实际情况，针对含“X”标识的部件，在此栏中提供更多技术说明。)</p>						

# Index

<b>A</b>		<b>H</b>	
Access controls	39	Handle	19
Ambient temperature	25	High flow	12
<b>B</b>		<b>I</b>	
Brightness	44	I/O port	45
<b>C</b>		<b>K</b>	
Calibrating		Keyboard lock	20
External Calibration Configuration and Start	61	<b>L</b>	
Time and general preferences	60	Language	34
Calibration adapter CalMate	65	Leak rate unit	35
CalMate	65	Low flow	12
Cathode	41	<b>M</b>	
Cleaning and maintenance	87	Main fuse	24
Cleaning works	87	Mains switch	34
Copy files	72	Maintenance	87
<b>D</b>		Measure	69
Date	35	Measurement display	20
Declaration of Contamination	91, 92	Measurement view	43
Degree of contamination	25	<b>N</b>	
Description	12	Noise behavior	69
Detection limit	12	<b>O</b>	
Dimensions	23	Operating voltage	23
<b>E</b>		Operation mode	13
Equivalence factor	55	<b>P</b>	
Equivalence leak rate	55	Power	23
Error message	79	Pressure unit	36
<b>F</b>		Protection class	24
Factory settings	25	<b>R</b>	
fan input	17		
<b>G</b>			
Gas flow	13		



---

Reset	78
Reset button	14, 21
Return	91

## S

---

Scope of delivery	11
Setting setpoints	59
Sniffer line	12
Sniffer mode	53
Speaker	14
Storage temperature	25

## T

---

Time	35
Touch PIN	11, 14, 21
Touchscreen	14, 15, 42

## U

---

USB flash drive	72
-----------------	----

## V

---

View	14, 15
------	--------

## W

---

Warning	44, 79
Weight	23

## X

---

XL3000flexRC	15, 33, 41
--------------	------------







Due to our continuing program of product improvements, specifications are subject to change without notice.  
The trademarks mentioned in this document are held by the companies that produce them.