

TYPE EVPP-D05

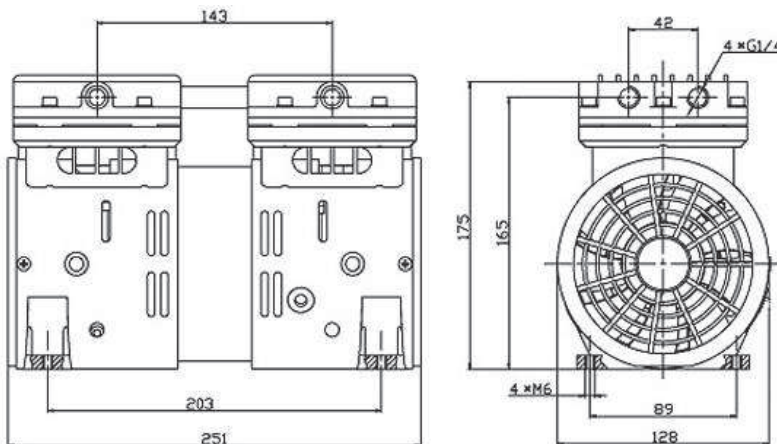
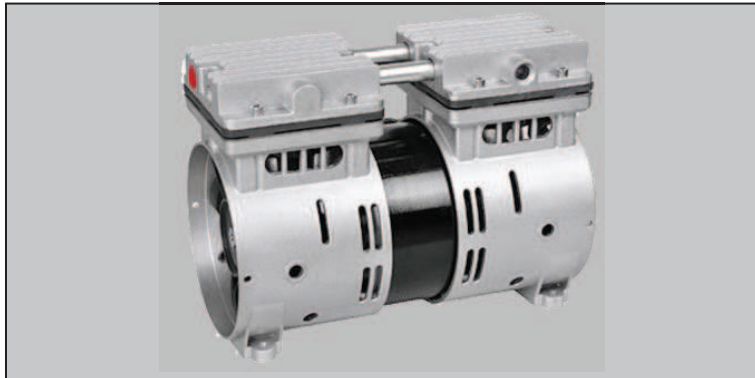

Technical Data		TYPE EVPP-D05	
		Vacuum	Pressure
Nominal displacement	l/m	118	118
Ultimate vacuum/pressure	bar	-0,92	+2,0
Motor power	W	330	480
Rotation speed @50Hz	rpm	1450	1400
Weight	kg	8,5	8,5
Noise (at ultimate pressure)	dB(A)	60	62
Admissible ambient temp.	°C	-5 to 40	-5 to 40
Connections	G(BSP)	1/4"	1/4"
Dimensions LxWxH	mm	251x128x175	251x128x175

Ordering Information	EVPP-D05	
EVPP-D05 with 230V, 50Hz motor	670.032	675.032
Damper G1/4"	670.900	
Accessories	See accessories page	